



Table with top made in solid Briccola planks, not glued, with straight sides and with a central iron compartment to store objects. The top is supported by four legs with a geometrical section.

**STANDARD VERSION:** IRON CENTRAL PROFILE LACQUERED IRONDUST COLOUR (B2); BRICCOLA LEGS, MADE FROM A SINGLE BLOCK

CODE	SIZE	A6
CANAL BRICCOLA 1	W.220 x D.110 x H.76,8	■
CANAL BRICCOLA 2	W.240 x D.110 x H.76,8	■
CANAL BRICCOLA 3	W.260 x D.110 x H.76,8	■

**AVAILABLE FINISHES:**

**A6:** briccola

FEASIBILITY LACQUERED IRON CENTRAL PROFILE	
B2	■
B3	■

**AVAILABLE FINISHES:**

**B2:** lacquered iron: irondust, RAL (only selected colours)



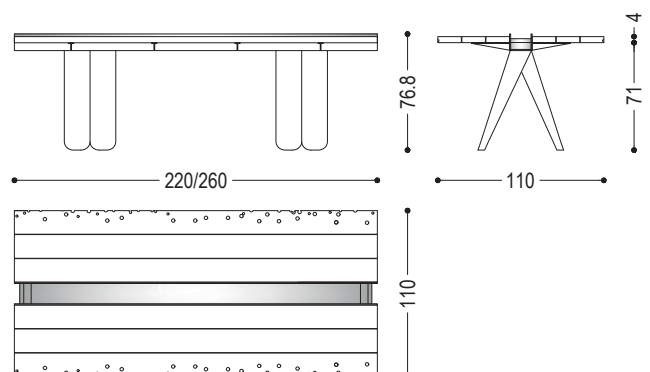

**B3:** lacquered iron matt brushed effect: aged copper, aged bronze, stainless steel, titanium  
lacquered iron oxidised effect



## WOOD

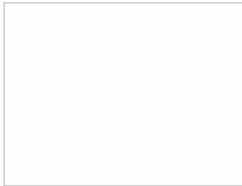

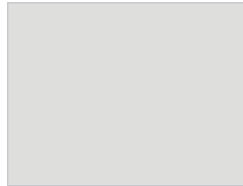
## IRON

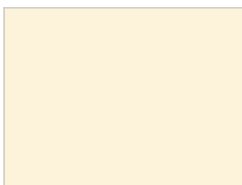
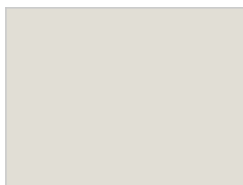
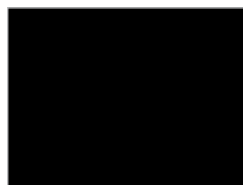
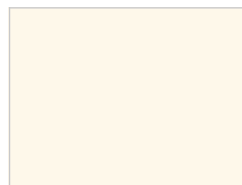
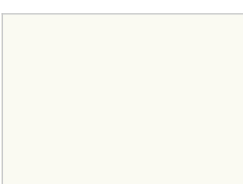
<b>B2</b>					
					
					
<b>B3</b>	