



Table with top made of solid wood, consisting of three single planks aligned, with middle gaps and natural sides, new version of the original model. Base in iron plate characterised by geometric lines.

STANDARD VERSION: IRON BASE LACQUERED IRONDUST COLOUR (B2)

CODE	SIZE	BASE	A1	A2	A4
BEDROCK-PLANK-THREE.DIR	W.200 x D.90/100 x H.76	B2	■	■	■
		B3	■	■	■
BEDROCK-PLANK-THREE 1.DIR	W.220 x D.90/100 x H.76	B2	■	■	■
		B3	■	■	■
BEDROCK-PLANK-THREE 2.DIR	W.240 x D.90/100 x H.76	B2	■	■	■
		B3	■	■	■
BEDROCK-PLANK-THREE 3.DIR	W.260 x D.90/100 x H.76	B2	■	■	■
		B3	■	■	■
BEDROCK-PLANK-THREE 4.DIR	W.280 x D.90/100 x H.76	B2	■	■	■
		B3	■	■	■
BEDROCK-PLANK-THREE 5.DIR	W.300 x D.90/100 x H.76	B2	■	■	■
		B3	■	■	■

AVAILABLE FINISHES:

- A1:** walnut with knots
- A2:** oak with knots
- A4:** oak with knots pigmented: total black
- B2:** lacquered iron: iron dust, RAL (only selected colours)
- B3:** lacquered iron matt brushed effect: aged bronze, stainless steel, titanium

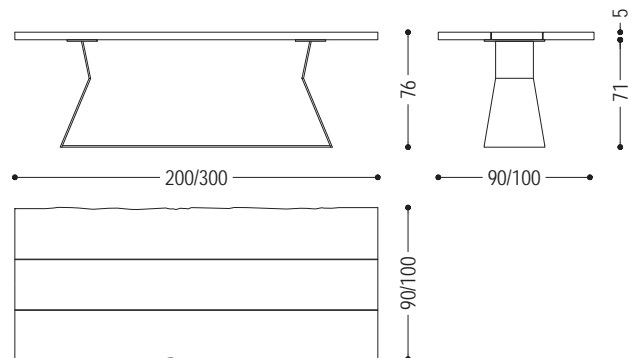

BEDROCK PLANK THREE | AVAILABLE FINISHES

WOOD

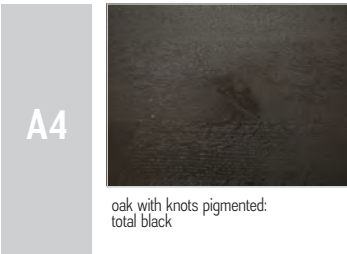
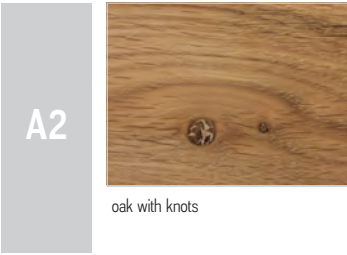
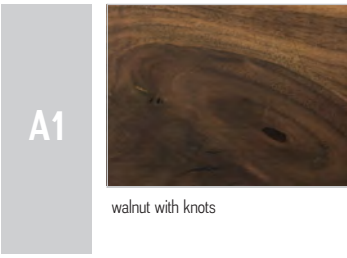

IRON

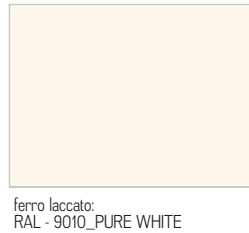
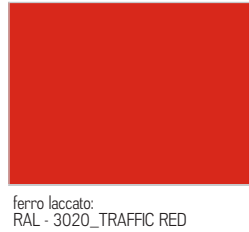
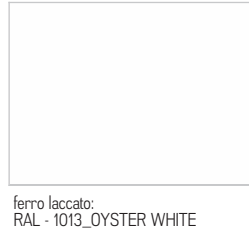
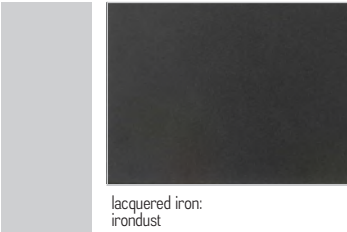

BEDROCK PLANK THREE | AVAILABLE FINISHES

B3

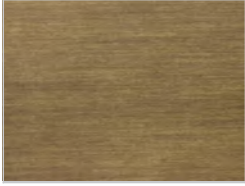

lacquered iron, matt brushed effect:
aged bronze



lacquered iron, matt brushed effect:
stainless steel

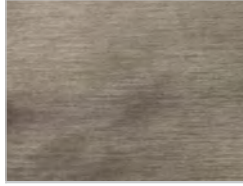

lacquered iron, matt brushed effect:
titanium