Febo

CHAIRS

Antonio Citterio



Description

In addition to the Febo family, which includes sofas, armchairs, chaise longue and beds, there are the chairs in three versions: the first has classic and extremely comfortable proportions, the second is reduced of cm 6 in height so as to be paired with the tea tables and the last one has a high back and more enveloping lines. All the chairs are available both in a single material covered in fabric or leather with prominent blanket stitch or with legs in grey oak, brushed light oak, brushed black oak or smoked stained oak.

Technical information

Internal frame:

tubular steel and steel profiles

Internal frame upholstery:

Bayfit® (Bayer®) flexible cold shaped polyurethane foam, polyester fibre cover

Legs:

solid wood: grey oak, brushed light oak, brushed black oak or smoked stained oak

Ferrules:

thermoplastic material

Cover:

fabric (blanket stitch) or leather (blanket stitch or raised stitch)

Technical drawings

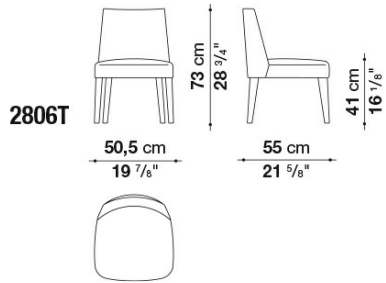

2806T

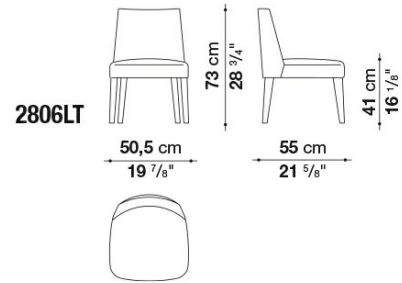

2806LT

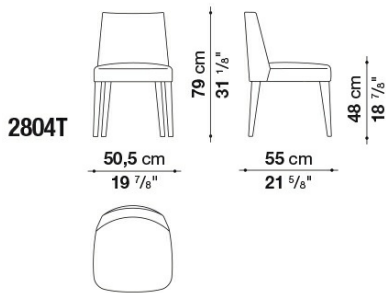

2804T

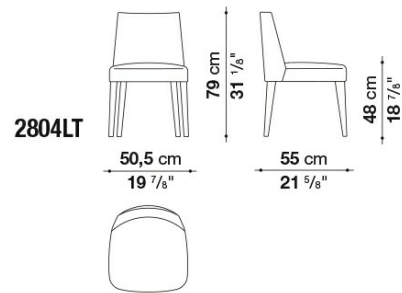

2804LT

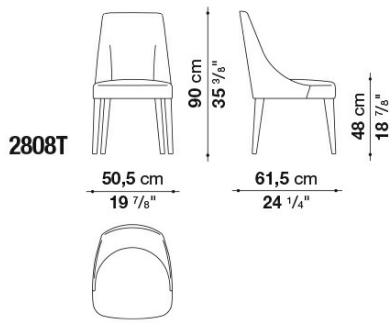

2808T

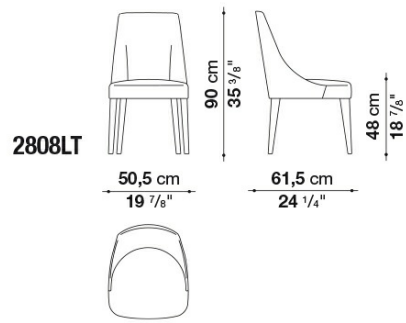

2808LT

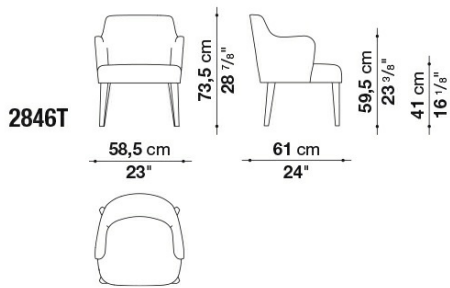

2846T

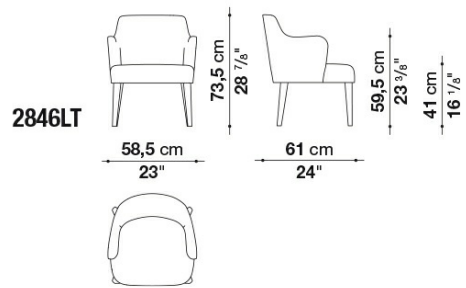

2846LT

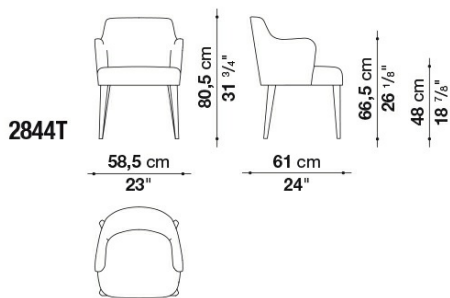

2844T

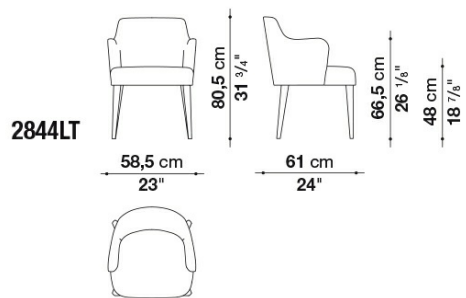

2844LT

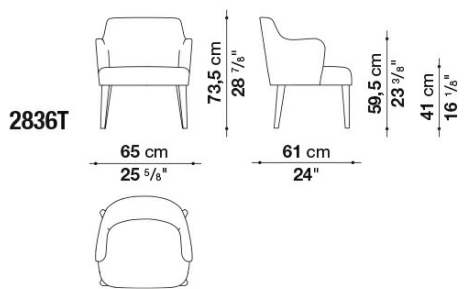

2836T

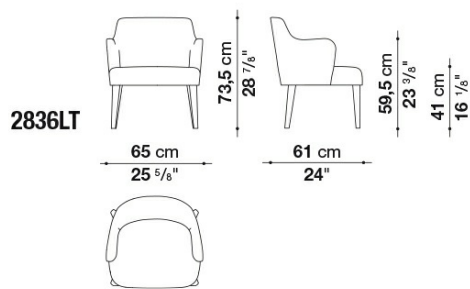

2836LT

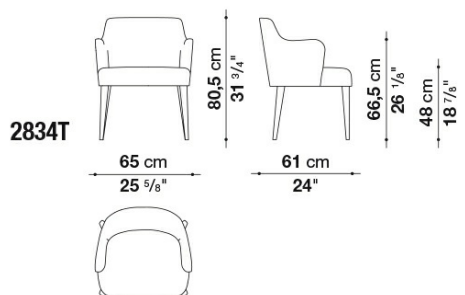

2834T

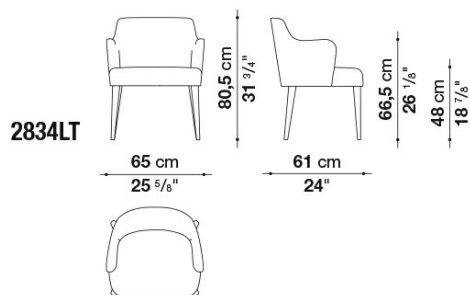

2834LT

B&B Italia reserves the right to make technological and aesthetic improvements to its models, including changes to the sizes and materials, without notice. The technical drawings do not define the details of the product. The measurements shown are indicative and may undergo changes. In particular, the dimensions relevant to the padded parts are subject to usage tolerances over time caused by the normal adjustment of the padding. For the specific information, please contact the dealer closest to you.