

BASIC

#rational creativity



BASIC

#rational creativity

/ Linear, essenziale, dal carattere deciso. In una parola, **BASIC**. Progettualità e creatività diventano particolarmente razionali, ponendosi come risposta perfetta per chi cerca una soluzione fresca e contemporanea per caratterizzare l'ambiente bagno. / Streamlined, essential, bold: these are the keywords that describe the **BASIC** collection. Design and creativity are combined rationally, delivering the perfect solution to those who prefer a fresh, contemporary bathroom. / Linear, schlicht, entschieden: mit diesen Stichworten kann man die **BASIC**-Kollektion beschreiben. Design und Kreativität werden rational kombiniert und liefern eine perfekte Einrichtungslösung für diejenigen, die ein frisches, modernes Badezimmerambiente bevorzugen. / Linéaire, essentielle, déterminée: ce sont les mots-clés qui décrivent la collection **BASIC**. Conception et créativité alliées à rationalité pour offrir la solution parfaite à tous ceux qui recherchent un espace salle de bains vivant et contemporain. / Lineal, esencial, de carácter decidido. En una palabra, **BASIC**. Proyección y creatividad se muestran particularmente racionales, dando como respuesta perfecta a quien busca una solución fresca y contemporánea para caracterizar el ambiente del baño.

INDEX



SOLUZIONI A
TERRA, VERSATILITÀ
NEL QUOTIDIANO.

SOLUZIONI SOPESE,
ESPRESSIONI DEL
VIVERE MODERNO.

/ Base e colonna in finitura
Lacklaminat "BA003",
lavabo in ceramica.

BASIC 01



#ESSENZIALITÀ



LA SEMPLICITÀ
SI DIMOSTRA
IMPECCABILE

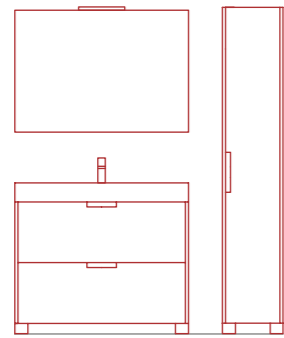

L 100+35 x P 45/25 cm

/ Approccio essenziale ed equilibrio compositivo sono i principi guida della collezione Basic. Linee semplici ma incredibilmente perfette.

/ Sleek, balanced style is the key ingredient of the Basic collection, which adopts simple yet incredibly perfect lines.

/ Schlichtheit und ein harmonischer Stil sind die Zutaten der Basic-Kollektion, die sich durch eine einfache, unglaublich perfekte Linienführung auszeichnet.

/ Le style essentiel et équilibré est le principe clé de la collection Basic: des lignes simples mais incroyablement parfaites.

/ Enfoque esencial y equilibrio compositivo son los principios que guían el modelo Basic. Líneas simples pero increíblemente perfectas.



BASIC 02

/ Base in finitura nobilitato
barrierato "BA991",
lavabo in ceramica e
specchio contenitivo.



*/ Eine lebendige Atmosphäre ist
das Ergebnis einer gelungenen
Kombination zwischen Formen
und Materialien. Die Lösung mit
doppeltem Waschbecken trägt zu einer
höheren Funktionalität im Bad bei.*

*/ Temperamento giovane,
frutto dell'unione tra forma e
materia. Spiccata funzionalità
definita dalla soluzione con il
doppio lavabo.*

*/ A lively atmosphere stems from
the successful combination of shapes
and materials. The double basin
solution enhances functionality in the
bathroom.*

*/ Un caractère jeune, fruit de
l'association des formes et des
matériaux. La solution avec double
vasque accentue la fonctionnalité de la
salle de bains.*

*/ Temperamento joven, fruto de la
unión entre la forma y la materia.
Destacada funcionalidad definida por
la solución con el doble lavabo.*



**IL DETTAGLIO
SOTTOLINEA IL
PROGETTO**

#120



INTERPRETAZIONE
DELLA
FUNZIONALITÀ

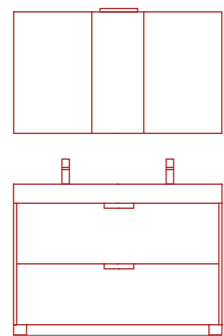

L 120 x P 45 cm



—
/ Il minimalismo sa essere accogliente. Modulo da 120 per soddisfare le esigenze di coloro che vogliono più spazio e più contenimento.

/ Minimal style and comfort can go hand in hand. This 120 cm module meets your requirements in terms of storage space.

/ Minimalistischer Stil und Komfort gehen Hand in Hand. Dieses 120 cm -Modul erfüllt sämtliche Anforderungen in Bezug auf Stauraum.

/ Le style minimaliste peut être accueillant. Ce module de 120 cm est en mesure de satisfaire vos exigences en termes d'espace de rangement.

/ El minimalismo sabe ser acogedora. Módulo de 120 para satisfacer las exigencias de los que quieren más espacio y más contención.

BASIC 03

/ Base in finitura Lacklaminat "BA004", lavabo in ceramica.



#120



BA003

BA002

SAPER
ACCOGLIERE
LE NECESSITÀ

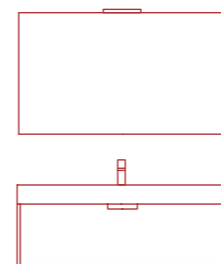

L 120 x P 45 cm

BA001

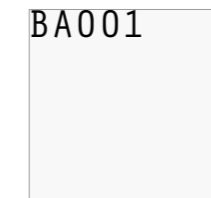

BASIC 04

/ Basi in finitura Lacklaminat
"BA001", lavabo in ceramica.



#SIMMETRIA



—
 ESPRESSIONE
 DI ORDINE E
 SIMMETRIA

—
 / Istantanee che segnano
 tendenze, che rendono
 accessibile l'armonia
 di un progetto dalle
 tonalità naturali.

/ Trendy furnishing solutions in
 a range of subtle colours lend a
 harmonious touch to the bathroom.

/ Trendorientierte
 Einrichtungslösungen in
 natürlichen Farbtönen verleihen
 dem Badezimmerambiente eine
 harmonische Note.

/ Des solutions d'ameublement
 de tendance dans une gamme de
 teintes naturelles apportant une note
 d'harmonie à la salle de bains.

/ Instantáneas que señalan
 tendencias, que devuelven accesible
 la armonía de un proyecto de las
 tonalidades naturales.

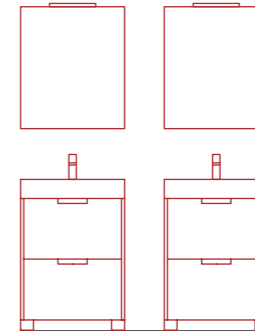

L 60+60 x P 45 cm



BASIC

#rational creativity

BASIC È SOSTANZA E FORMA.
È MODERNO ED È ACCOGLIENTE.
È ESSENZA E LUCENTEZZA.

*Basic is all about combining
shape and substance.
It is modern, cosy and filled
with light.*

*Bei der Basic-Kollektion
dreht sich alles um Form
und Substanz.*

*Basic est la combinaison de
substance et de forme.
Elle est moderne, accueillante et
pleine de lumière.*

*Basic es sustancia y forma.
Es moderno y acogedor.
Es esencia y brillo.*

UN PROGRAMMA ADATTABILE AD OGNI
SPAZIO E CONTESTO ABITATIVO.
DOVE LA LIBERTÀ È SINONIMO DI PERSONALITÀ.

*The Basic collection is perfectly
adaptable to any requirement in
terms of space and blends well with
existing furnishing decors, expressing
your freedom and personal style.*

*Diese moderne, einladende und
lichtdurchflutete Kollektion erfüllt
sämtliche Raumbedürfnisse und lässt
sich in jedes Ambiente einfügen.
Freiheit ist hier ein Synonym für
einen ganz individuellen Stil.*

*Cette collection est adaptable à
toute condition d'espace et s'intègre
parfaitement avec tout style
d'aménagement existant, offrant
liberté et personnalisation.*

*Un programa adaptable a cada
espacio y contexto de la vivienda.
Donde la libertad es sinónimo de
personalidad.*

BASIC 05

/ Base in finitura Lacklaminat
"BA003", lavabo in ceramica.



—
STILE PURO
E CREATIVO

—
/ Tonalità naturali si innestano all'interno di percorsi creativi d'arredo. Pensieri liberi ed una freschezza ritrovata definiscono un nuovo stile.

/ Natural colours are the protagonists of creative furnishing styles. Free thoughts and a newfound sense of freshness are the main ingredients of a brand-new style.

/ Natürliche Farben sind die Protagonisten eines kreativen Einrichtungsstils. Freie Gedanken und ein neu gewonnenes Gefühl der Frische sind die Hauptzutaten eines neuen Stils.

/ Des teintes naturelles deviennent les protagonistes de styles créatifs d'ameublement. Des pensées libres et une sensation de fraîcheur retrouvée caractérisent un tout nouveau style.

/ Tonalidades naturales se encauzan dentro de recorridos creativos de decoración. Pensamientos libres y un frescor hallado definen un nuevo estilo.

#80



BA991



BA992

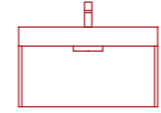
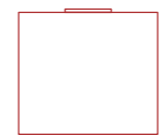

L 80 x P 45 cm

/ Base e colonna in finitura
Lacklaminat "BA002",
lavabo in ceramica.

BASIC 06



#FUNZIONALITÀ



GEOMETRIE DALLA
VOCAZIONE
FUNZIONALE



/ Geometria e proporzione restituiscono una soluzione completa in ogni suo aspetto. Il design puro abbraccia il concetto di comfort altamente funzionale.

/ Proportioned geometric shapes are the essential elements of a complete furnishing solution. Pure design goes together with highly functional comfort.

/ Geometrische Formen und wohl durchdachte Proportionen sind die wesentlichen Elemente einer umfassenden Einrichtungslösung. Pures Design wird mit praktischem Komfort kombiniert.

/ Des formes géométriques proportionnées constituent les éléments essentiels d'une solution d'ameublement complète. Le design pur accompagne le concept de confort hautement fonctionnel.

/ Geometría y proporción devuelven una solución completa en cada su aspecto. El diseño puro abraza el concepto de confort sumamente funcional.

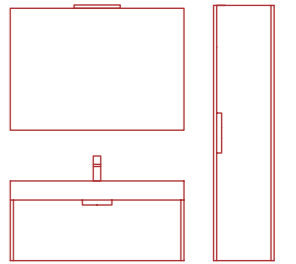

L 100+35 x P 45/25 cm

BASIC 07



/ Basi in finitura nobilitato
barrierato "BA992", lavabo in
ceramica e specchio contenitivo.

/ L'essenza è sempre sinonimo di eleganza. Un approccio stilistico che rompe gli schemi di un'estetica rigorosa, trasformando atmosfera e percezione.

/ Wood finishes are always synonymous with exceptional elegance. This stylistic approach breaks away from rigorous aesthetical principles, transforming atmospheres and perceptions.

/ Holzoberflächen sind immer gleichbedeutend mit außergewöhnlicher Eleganz. Dieser stilistische Ansatz bricht mit den strengen ästhetischen Prinzipien und verwandelt Atmosphären und Wahrnehmungen.

/ Les finitions bois sont toujours synonyme d'élégance. L'approche stylistique s'écarte des principes esthétiques rigoureux pour transformer les atmosphères et les perceptions.

/ La esencia siempre es sinónimo de elegancia. Un enfoque estilístico que rompe los esquemas de una estética rigurosa, transformando atmósfera y percepción.

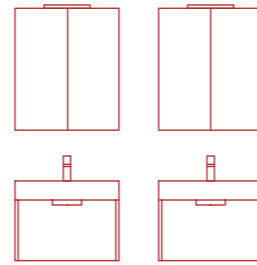

L 60+60 x P 45 cm



#60



LUCI E
RIFLESSI NEL
QUOTIDIANO

— / La finitura lucida rimanda a concetti legati ad un'estetica moderna ed accattivante che si esalta attraverso tratti definiti ed uniformi.

/ Glossy finishes inspired by modern aesthetics are enhanced by clearly defined, uniform lines.

/ Glänzende Oberflächen inspiriert von einer modernen, ansprechenden Ästhetik werden durch klare, einheitliche Linien hervorgehoben.

/ Les finitions brillantes s'inspirant de concepts liés à une esthétique moderne et attrayante sont mises en valeur par les lignes nettes et uniformes.

/ El acabado brillo pospone a conceptos relacionados a una estética moderna y atractiva que se exalta por rasgos definidos y uniformes.

BASIC 08

/ Base in finitura Lacklaminat "BA002", lavabo in ceramica.

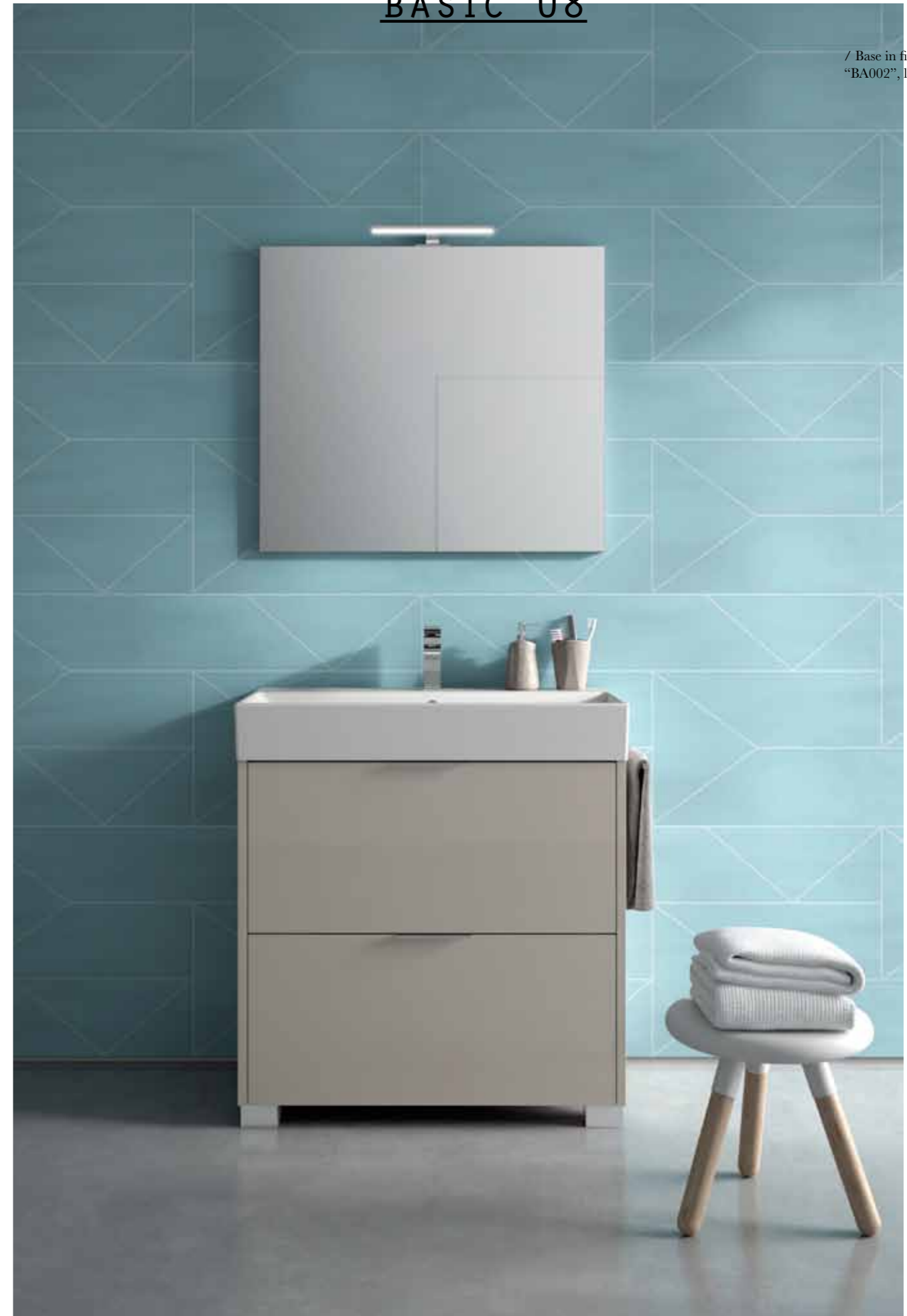

#80



BA991

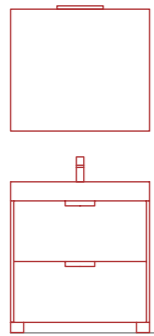

L.80 x P.45 cm



APPROCCI
DI NATURA
ELEGANTE

BA992



BASIC 09

/ Base in finitura Lacklaminat
"BA004", lavabo in ceramica.



/ La praticità si esprime
in modo inequivocabile
accogliendo il design
contemporaneo della
composizione. Dettagli dai
profili decisi completano il
programma d'arredo.

*/ Utility is expressed unequivocally
by successfully blending with
modern design. Sleek details
lend the finishing touch to this
sensational furnishing collection.*

*/ Zweckdienlichkeit äußert sich
eindeutig durch die erfolgreiche
Kombination mit einem modernen
Design. Ansprechende Details
verleihen der Kollektion den letzten
Schliff.*

*/ La praticité s'exprime de manière
incontestable en se combinant
au design contemporain de la
composition. Des détails aux profils
marqués complètent la collection
d'ameublement.*

*/ La funcionalidad se expresa de
modo inequívoco acogiendo el diseño
contemporáneo de la composición.
Detalles de los perfiles decididos
completan el programa de decoración.*

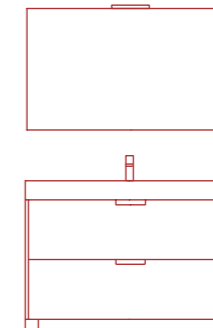

L 120 x P 45 cm

L'AMBIENTE BAGNO DESCRITTO DA BASIC EVIDENZIA
 ECCELLENTE FUNZIONALITÀ E DESIGN D'ISPIRAZIONE
 CONTEMPORANEA, PENSATO PER COLORO CHE CERCANO
 LA QUALITÀ DA DECLINARE AL LIFESTYLE ODIERNO.



A BASIC bathroom
 environment focuses on utility
 and modern design, as it is
 specifically designed for people
 who are after quality in their
 daily lifestyle.

Ein mit der BASIC-
 Kollektion ausgerichtetes
 Badezimmer fokussiert auf
 Zweckdienlichkeit und auf
 ein modernes Design. Es ist
 speziell für Menschen gedacht,
 deren Lebensstil auf Qualität
 ausgelegt ist.

Un espace salle de bains créé
 par BASIC est caractérisé par
 une excellente fonctionnalité
 et un design d'inspiration
 contemporaine, conçu pour tous
 ceux qui cherchent la qualité
 dans leur vie quotidienne.

El ambiente del baño descrito
 por BASIC evidencia una
 excelente función y diseño de
 inspiración contemporánea,
 creado a los que buscan la
 calidad que declina al lifestyle
 actual.

FINITURE
 FINISHES / AUSFÜHRUNGEN
 / FINITIONS / ACABADOS

ESSENZE

WOODS
 HOLZARTEN
 FINITIONS
 MADERAS



BA991

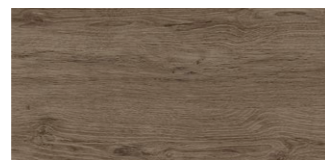

BA992

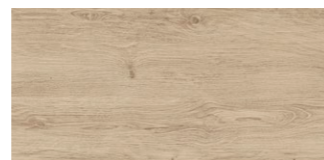

BA993

COLORI LACKLAMINAT LUCIDI

GLOSS LACKLAMINAT COLOURS
 GLÄNZENDEN LACKLAMINAT FARBEN
 LAQUES BRILLANTS LACKLAMINAT POLYMÈRES
 LACADOS BRILLOS LACKLAMINAT POLIMÉRICOS

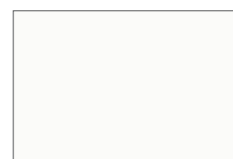

BA001



BA002



BA003



BA004

COLORI LACKLAMINAT OPACHI

MATT LACKLAMINAT COLOURS
 MATT LACKIERTE LACKLAMINAT FARBEN
 LAQUES MATS LACKLAMINAT POLYMÈRES
 LACADOS OPACOS LACKLAMINAT POLIMÉRICOS



BA005



BA006



BA007



BA008

LACCATI METAL COLOR OPACHI

MATT METAL LACQUERS
 MATTE LACKAUSFÜHRUNGEN METAL
 LAQUÉS METAL MATS
 LACADOS METAL MATE



ORO



RAME



TITANIO



BIANCO
PERLATO

LACCATI OPACHI, LUCIDI, SOFT TOUCH

MATT, GLOSS LACQUERED AND SOFT TOUCH COLOURS
 GLÄNZENDEN LACKIERTE FARBEN UND SOFT TOUCH
 LAQUES MATS, BRILLANTS ET SOFT TOUCH
 LACADOS OPACOS, BRILLOS Y SOFT TOUCH

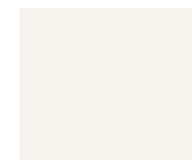

BIANCO

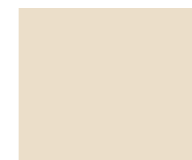

PERLA

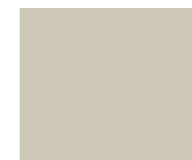

SAHARA

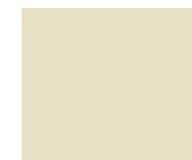

BEIGE AVORIO



SENAPE



MALTO



GIALLO BIKINI



BISCOTTO



CAPPUCCINO



TORTORA



MARRONE TERRA



VERDE SALVIA



VERDE CANNA



VERDE BLUAstro



BLU ACCIAIO



PETROLIO



AZZURRO INDIA



VERDE MARINO



BLU PASTELLO



COBALTO



CURACAO



ROSSO ARANCIO



ROSSO GIAMAICA



ROSSETTO



ROSSO CUOIO



ROSSO SCURO



GRIGIO VIOLA



ORCHIDEA



DIVA



CONFETTO



NOCE MOSCATA



MEDIOEVO



GRIGIO CENERE



GRIGIO SETA



GRIGIO NUVOLA



POLVERE

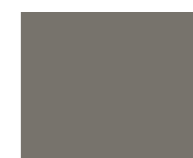

GRIGIO PIETRA

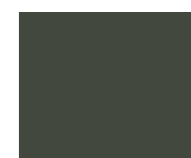

GRIGIO LONDRA



GRIGIO
TRAFFICO



MARRONE GRIGIO
No SOFT TOUCH



NERO
No SOFT TOUCH

INFORMAZIONI TECNICHE

TECHNICAL DETAILS

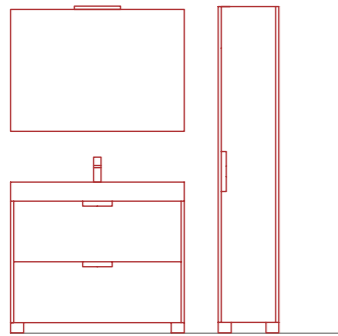

BASIC01

Pag. 04 > 07

Composizione	L 100+35 x P 45/25 cm	
Base	L 100 x H 76 x P 45 cm	Lacklaminat "BA003"
Lavabo	L 100 x H 11 x P 45 cm	Ceramica
Colonna	L 35 x H 188 x P 25 cm	Lacklaminat "BA003"
Specchio	L 100 x H 70 cm	---

Lacklaminat "BA003" finish base unit and tall unit. Ceramic washbasin. / Unterschrank und Hochschrank in der Ausführung Lacklaminat "BA003". Waschbecken aus Keramik. / Base et colonne avec finition Lacklaminat «BA003», vasque en céramique. / Base y columna en acabado Lacklaminat "BA003", lavabo en cerámica.

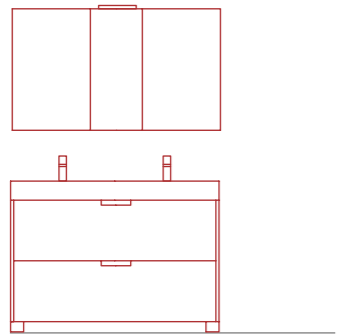

BASIC02

Pag. 08 > 11

Composizione	L 120 x P 45 cm	
Base	L 120 x H 76 x P 45 cm	Nobilitato barrierato "BA991"
Lavabo	L 120 x H 11 x P 45 cm	Ceramica
Specchio contenitivo	L 120 x H 70 x P 16,6 cm	---

"BA991" reinforced melamine finish base unit. Ceramic washbasin with mirror cabinet. / Unterschrank in der Ausführung "BA991" mit Barrierepapier beschichtet. Waschbecken aus Keramik und Spiegelschrank. / Base avec finition en mélaminé renforcé «BA991», vasque en céramique et miroir armoire. / Base en acabado en fibra dura doble espesor "BA991", lavabo en cerámica y espejo contenedor.

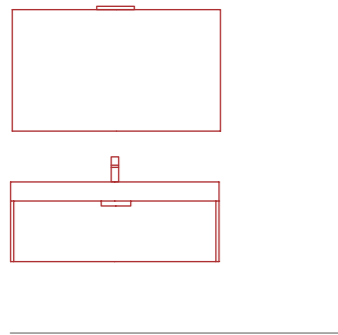

BASIC03

Pag. 12 > 15

Composizione	L 120 x P 45 cm	
Base	L 120 x H 35 x P 45 cm	Lacklaminat "BA004"
Lavabo	L 120 x H 11 x P 45 cm	Ceramica
Specchio	L 120 x H 70 cm	---

Lacklaminat "BA004" finish base unit. Ceramic washbasin. / Unterschrank in der Ausführung Lacklaminat "BA004". Waschbecken aus Keramik. / Base avec finition Lacklaminat «BA004», vasque en céramique. / Base en acabado Lacklaminat "BA004", lavabo en cerámica.

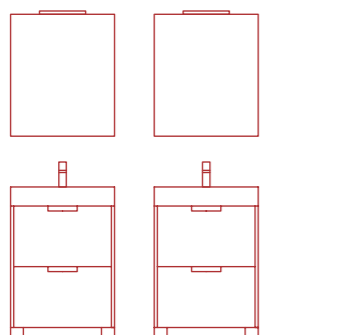

BASIC04

Pag. 16 > 19

Composizione	L 60+60 x P 45 cm	
Basi	L 60+60 x H 76 x P 45 cm	Lacklaminat "BA001"
Lavabo	L 60 x H 11 x P 45 cm	Ceramica
Specchio	L 60+60 x H 70 cm	---

Lacklaminat "BA001" finish base units. Ceramic washbasin. / Unterschrank in der Ausführung Lacklaminat "BA001". Waschbecken aus Keramik. / Base avec finition Lacklaminat «BA001», vasque en céramique. / Base en acabado Lacklaminat "BA001", lavabo en cerámica.

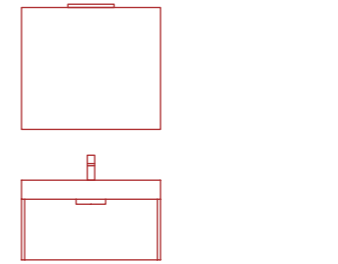

BASIC05

Pag. 22 > 25

Composizione	L 80 x P 45 cm	
Base	L 80 x H 35 x P 45 cm	Lacklaminat "BA003"
Lavabo	L 80 x H 11 x P 45 cm	Ceramica
Specchio	L 80 x H 70 cm	---

Lacklaminat "BA003" finish base unit. Ceramic washbasin. / Unterschrank in der Ausführung Lacklaminat "BA003". Waschbecken aus Keramik. / Base avec finition Lacklaminat «BA003», vasque en céramique. / Base en acabado Lacklaminat "BA003", lavabo en cerámica.

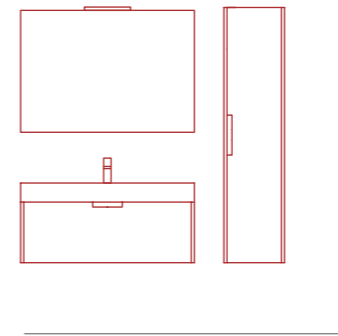

BASIC06

Pag. 26 > 29

Composizione	L 100+35 x P 45/25 cm	
Base	L 100 x H 35 x P 45 cm	Lacklaminat "BA002"
Lavabo	L 100 x H 11 x P 45 cm	Ceramica
Colonna	L 35 x H 147 x P 25 cm	Lacklaminat "BA002"
Specchio	L 100 x H 70 cm	---

Lacklaminat "BA002" finish base unit and tall unit. Ceramic washbasin. / Base und Hochschrank in der Ausführung Lacklaminat "BA002". Waschbecken aus Keramik. / Base et colonne avec finition Lacklaminat «BA002», vasque en céramique. / Base y columna en acabado Lacklaminat "BA002", lavabo en cerámica.

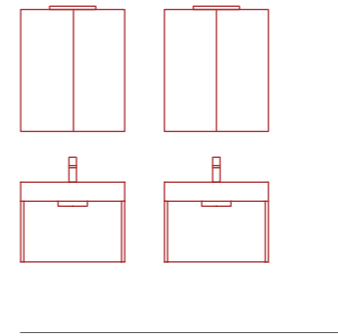

BASIC07

Pag. 30 > 33

Composizione	L 60+60 x P 45 cm	
Basi	L 60+60 x H 35 x P 45 cm	Nobilitato barrierato "BA992"
Lavabo	L 60 x H 11 x P 45 cm	Ceramica
Specchio contenitivo	L 60+60 x H 70 x P 16,6cm	---

"BA992" reinforced melamine finish base units. Ceramic washbasin and mirror cabinet. / Unterschrank in der Ausführung "BA992" mit Barrierepapier beschichtet. Waschbecken aus Keramik und Spiegelschrank. / Bases avec finition en mélaminé renforcé «BA992», vasque en céramique et miroir armoire. / Base en acabado en fibra dura doble espesor "BA992", lavabo en cerámica y espejo contenedor.

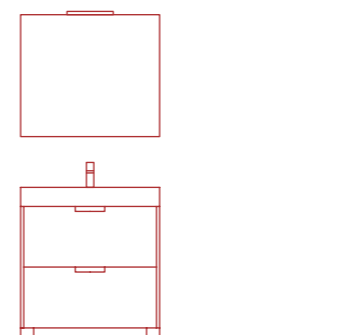

BASIC08

Pag. 34 > 37

Composizione	L 80 x P 45 cm	
Basi	L 80 x H 76 x P 45 cm	Lacklaminat "BA002"
Lavabo	L 80 x H 11 x P 45 cm	Ceramica
Specchio	L 80 x H 70 cm	---

Lacklaminat "BA002" finish base unit. Ceramic washbasin. / Unterschrank in der Ausführung Lacklaminat "BA002". Waschbecken aus Keramik. / Base avec finition Lacklaminat «BA002», vasque en céramique. / Base en acabado Lacklaminat "BA002", lavabo en cerámica.

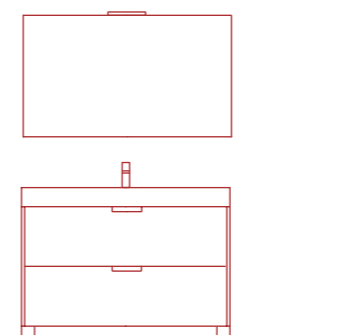

BASIC09

Pag. 38 > 41

Composizione	L 120 x P 45 cm	
Base	L 120 x H 76 x P 45 cm	Lacklaminat "BA004"
Lavabo	L 120 x H 11 x P 45 cm	Ceramica
Specchio	L 120 x H 70 cm	---

Lacklaminat "BA004" finish base unit. Ceramic washbasin. / Unterschrank in der Ausführung Lacklaminat "BA004". Waschbecken aus Keramik. / Base avec finition Lacklaminat «BA004», vasque en céramique. / Base en acabado Lacklaminat "BA004", lavabo en cerámica.

ITALIAN DESIGN

Ogni “prodotto” IDEAGROUP viene realizzato in Italia ma ciò che lo rende un esempio di Made in Italy per eccellenza (al 100%) sono i suoi valori: la creatività, la tradizione nel mondo del mobile che risale al 1987 e la qualità, caratteristica naturale per un’azienda che si confronta giornalmente con il proprio pubblico e le sue esigenze. Tutto ciò si traduce in un’esperienza e in un know-how specifici.

„All IDEAGROUP “products” are manufactured in Italy. Their unique values turn them into excellent examples of 100% Italian style: creativity, a long cabinetmaking tradition since 1987 and quality, which is a natural characteristic of a company that caters for its customers’ needs on a daily basis. All of this translates into specific experience and know-how.

„Jedes “Produkt” von IDEAGROUP wird in Italien angefertigt, aber es sind seine Werte, die es zu einem gelungenen Beispiel des “Made in Italy” (zu 100%) machen: die Kreativität, die Tradition in der Möbelwelt, die auf das Jahr 1987 zurückgeht, und die Qualität, eine natürliche Eigenschaft für einen Betrieb, der sich täglich mit den Kunden und deren Bedürfnissen auseinandersetzt. All das zeugt von einer eingehenden Erfahrung und einem spezifischen Know-how.

„Chaque « produit » IDEAGROUP est réalisé en Italie, mais plus que cela, ce qui en fait un excellent exemple de style 100 % Made in Italy ce sont ses valeurs : la créativité, la tradition comme producteur de meubles depuis 1987 et la qualité, caractéristique naturelle pour une entreprise qui se mesure quotidiennement avec son public et ses exigences. Tout cela se traduit dans une expérience et dans un savoir-faire spécifiques.

„Cada “producto” IDEAGROUP viene fabricado en Italia, pero lo que la convierte en un ejemplo de Made in Italy por excelencia (al 100%) son sus valores: la creatividad, la tradición en el mundo del mueble que nos remonta al 1987 y la calidad, característica natural de una empresa que se confronta diariamente con el propio público y sus exigencias. Todo ello se traduce en una experiencia y en un Know-how específico.

EUROPEAN MATERIALS

I materiali che compongono i nostri prodotti provengono esclusivamente dal Mercato Comune Europeo.

„Our products are made exclusively with materials sourced in the European Union.

„Die Materialien, mit denen unsere Produkte angefertigt wurden, stammen ausschließlich aus dem Europäischen Binnenmarkt.

„Les matériaux qui composent nos produits proviennent exclusivement de l’Union Européenne.

„Los materiales que componen nuestros productos provienen exclusivamente del Mercado Común Europeo.



Idropan garantisce la migliore difesa all’umidità alla quale il mobile può essere accidentalmente esposto. Una sicurezza in più per proteggere un mobile di qualità.

„Idropan provides for better resistance in case of accidental exposure to humidity. Added protection for your top-quality furniture.

„Idropan gewährleistet den besten Schutz vor der Feuchtigkeit, der ein Möbel aus Versehen ausgesetzt werden kann. Eine zusätzliche Sicherheit, um qualitativ hochwertige Möbel zu schützen.

„Idropan garantit la meilleure défense contre l’humidité à laquelle le meuble peut être accidentellement exposé. Une sécurité en plus pour protéger un meuble de qualité.

„Hidropan garantiza la mejor defensa a la humedad a la que el mueble puede estar sometido accidentalmente. Mayor seguridad para proteger un mueble de calidad.



È un pannello di tipo truciolare nel quale viene impiegato solo legno riciclato, con materiali ecocompatibili. È dotato di notevole solidità, compattezza, indeformabilità e resistenza.

„This is a type of particleboard panel which is made of recycled wood and environment-friendly materials. It is remarkably solid, does not deform, and is durable.

„Es handelt sich um eine Spanplatte, für deren Anfertigung ausschließlich recyceltes Holz, d.h. umweltfreundliche Materialien, verwendet wird. Sie ist besonders stabil, kompakt, unverformbar und widerstandsfähig.

„C’est un panneau de particules de bois dans lequel est utilisé uniquement du bois recyclé, avec des matériaux écocompatibles. Il est caractérisé par une remarquable solidité, compacité, indéformabilité et résistance.

„Es un panel de tipo aglomerado en el que se emplea únicamente madera reciclada, con materiales ecocompatibles. Indeformable y compacto, dotado de una notable solidez y resistencia.

Mdf

MDF: sigla di Medium Density Fiberboard, ovvero “pannello a media densità”. Dalle ottime caratteristiche meccaniche, molto stabile e compatto, questo pannello è in grado di offrire una buona resistenza all’umidità, con minima emissione di formaldeide.

„Abbreviation for Medium Density Fibreboard. It offers exceptional mechanical characteristics and is very stable and solid. This panel offers excellent resistance to moisture, with minimal emissions of formaldehyde.

„MDF: Abkürzung für Medium Density Fiberboard, d.h. “mitteldichte Holzfaserverplatte”. Diese Platte, die hervorragende mechanische Eigenschaften aufweist und sehr stabil und kompakt ist, ist besonders wasserfest und zeichnet sich durch minimale Formaldehydemissionen aus.

„MDF: abréviation de Medium Density Fiberboard, à savoir « panneau de fibres à densité moyenne ». Il présente des caractéristiques mécaniques optimales et est très stable et solide. Le panneau est en mesure d’offrir une bonne résistance contre l’humidité, avec une émission minimale de formaldéhyde.

„MDF: sigla de Medium Density Fiberboard, ó bien “panel a media densidad”. De óptimas características mecánicas, muy estable y compacto, este panel está en grado de ofrecer una buena resistencia a la humedad, con mínima emisión de formaldehído.



CATAS è il punto di riferimento in Italia per le prove di laboratorio in questo settore e certifica il prodotto in base alle normative tecniche italiane, europee e internazionali per quanto riguarda la resistenza meccanica, le prove reazione fuoco, la sicurezza arredamento, l’emissione formaldeide, l’analisi difetti legno, e molto altro ancora.

„CATAS is a reference research centre and laboratory for furniture companies in Italy, which certifies products according to Italian, European and international technical regulations with reference to mechanical resistance, fire reaction, safety, formaldehyde emissions, wood defect analyses and much more.

„CATAS ist der Bezugspunkt in Italien für die Laborprüfungen in diesem Sektor und zertifiziert das Produkt auf der Grundlage der italienischen, europäischen und internationalen technischen Vorschriften im Zusammenhang mit der mechanischen Festigkeit, der Prüfungen der Feuerbeständigkeit, der Sicherheit, der Formaldehydemission, der Analyse von Holzdefekten usw.

„CATAS est le centre de recherche et laboratoire de référence en Italie pour l’industrie du meuble, qui certifie le produit conformément aux réglementations techniques italiennes, européennes et internationales en ce qui concerne la résistance mécanique, les essais de réaction au feu, la sécurité des meubles, l’émission de formaldéhyde, l’analyse des défauts du bois et beaucoup plus encore.

„CATAS es el punto de referencia en Italia para las pruebas de laboratorio en este sector y certifica el producto en base a las normativas técnicas italianas, europeas e internacionales por lo que concierne la resistencia mecánica, las pruebas a reacción del fuego, la seguridad en la decoración, la emisión formaldehído, el análisis defectos de madera, y mucho más.

CREDITS:

Blob
Basic - Rational creativity (Gennaio2016)
AD: Ideagroup
Concept: Neiko
Images: Neiko
Printed in Italy by: Grafiche Antiga

Blob srl si riserva la facoltà di modificare, in qualunque momento e senza preavviso, le caratteristiche tecniche degli elementi illustrati nel presente catalogo. Declina ogni responsabilità per eventuali inesattezze contenute nello stesso.

Blob srl reserves the right to modify the technical characteristics of the elements contained in this catalogue without notice and shall not be liable for any inexactness contained herein.

Blob srl behält sich das Recht vor, die technischen Eigenschaften der im vorliegenden Katalog abgebildeten Elemente jederzeit und ohne Vorbescheid zu ändern. Man lehnt jede Haftung für eventuelle im Katalog enthaltene Fehler ab.

Blob srl se réserve la faculté de modifier, dans tout moment et sans avis préalable, les caractéristiques techniques des éléments montrés dans ce catalogue. L'entreprise décline toute responsabilité pour d'éventuelles inexactitudes dans le présent catalogue.

Blob srl se reserva la facultad de modificar, en cualquier momento y sin previo aviso, las características técnicas de los elementos ilustrados en el presente catálogo. Idea srl declina toda responsabilidad por eventuales inexactitudes del mismo catálogo.



BLOB

Blob srl
Via Vicenza, 7- 31046 Oderzo (TV) Italy
Tel +39 0422 814987 Fax +39 0422 814074
www.ideagroup.it blob@ideagroup.it