



Series of small tables made of solid wood, available in various diameters and heights, with possibility of stacking one over the other. The legs pass through the top and are visible on the surface.







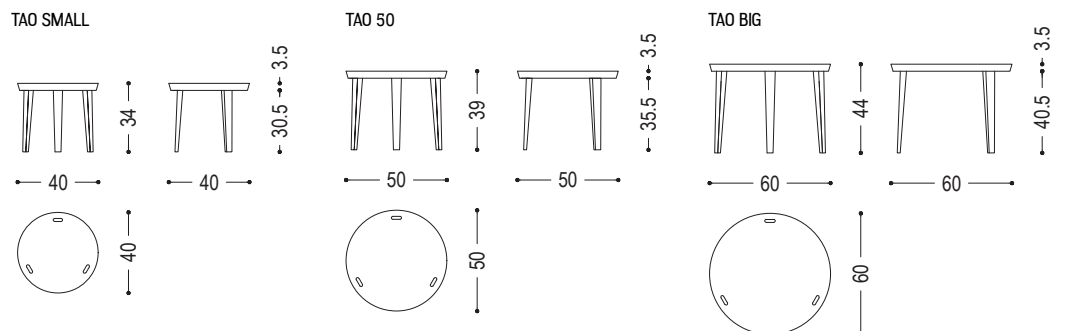

CODE	SIZE	A1	A2	A3	A4
TAO SMALL	Ø 40 x H.34	■	■	■	■
TAO 50	Ø 50 x H.39	■	■	■	■
TAO BIG	Ø 60 x H.44	■	■	■	■

AVAILABLE FINISHES:

- A1: walnut without knots, elm
- A2: oak without knots, cherry, maple
- A3: oak without knots finish: whitened, mystic black, neutro
- A4: oak without knots pigmented: ash grey, white milk, total black



WOOD

A1			
	walnut without knots	elm	
A2			
	oak without knots	cherry	maple
A3			
	oak without knots finish: whitened	oak without knots finish: mystic black	oak without knots finish: neutro
A4			
	oak without knots pigmented: ash grey	oak without knots pigmented: white milk	oak without knots pigmented: total black