

# SIPARIO 2011

## INSTRUCTIONS TO CALCULATE THE PRICE FOR COMPOSITIONS SIPARIO 2011

The modules with drawer (such as the modules with flap fronts) are made of independent components that can be combined and screwed together. To obtain the price of the composition add the prices of the single elements (also of different widths): base units with drawer / base units with flap front, shelves and wall units.

## INFORMATION REGARDING COMPOSITIONS SIPARIO 2011

The blockboard top is made with a single veneering up to a maximum length of 320 cm. Longer tops will be made in two or more pieces based according to the final finished size, with continuous veneer. The drawers are on metal runners with "soft closing" system.

STANDARD HANDLE: GROOVED ON THE DRAWER OR DOOR FRONT

## ELEMENTS OF THE COMPOSITION

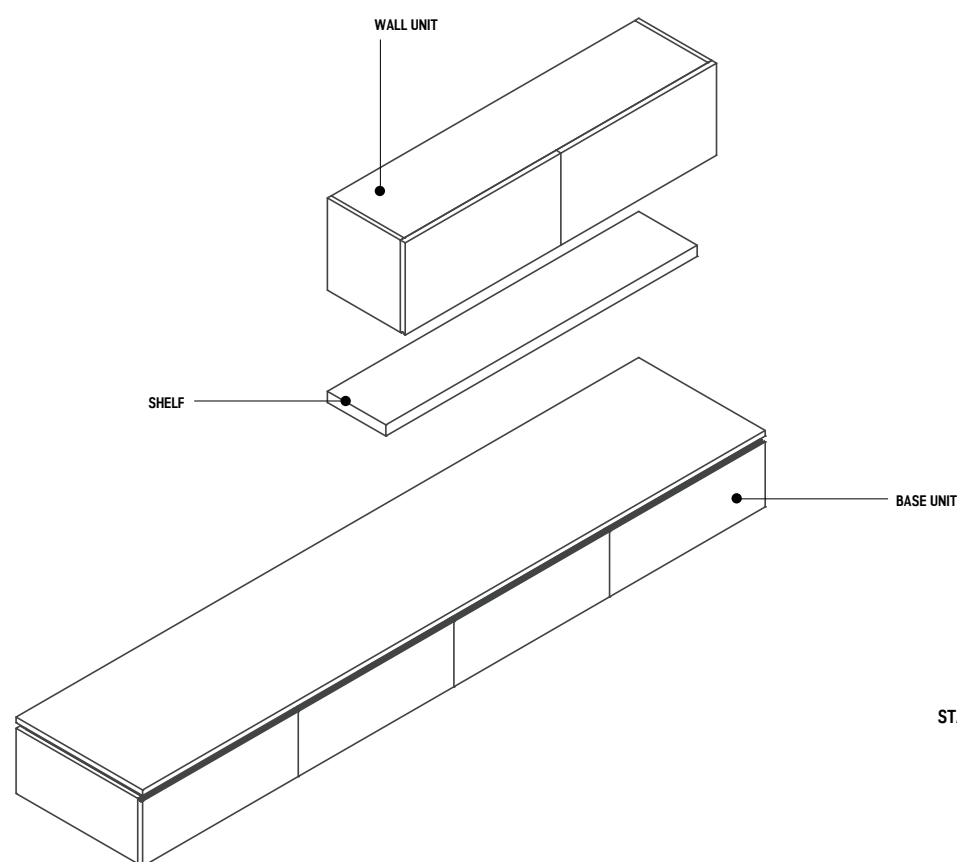

## STANDARD COMPOSITION

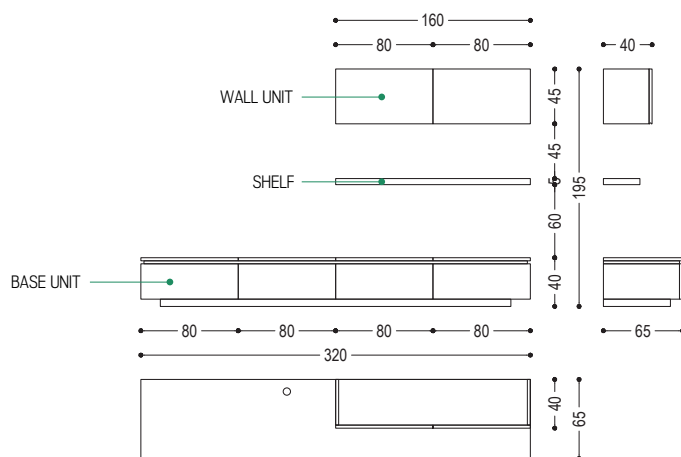



Modular system in solid wood and blockboard, characterized by different modules to be combined with each other.

**ADDITIONAL ACCESSORIES:** SEE TECHNICAL NOTES

**STANDARD VERSION:** DRAWERS ON METAL RUNNERS; GROOVED HANDLES

N.B. THE PRICE OF THE COMPOSITION IS CALCULATED AS PER PICTURE, INCLUDED THE SURCHARGE FOR THE CABLE PASSAGE HOLE AND THE SURCHARGE FOR THE HANGING UNITS' FRONTS IN LACQUERED GLASS

COMPOSITION		
CODE	SIZE	A1
SIPARIO-PROJECT-1-M-11	W.320 x D.65 x H.195	■

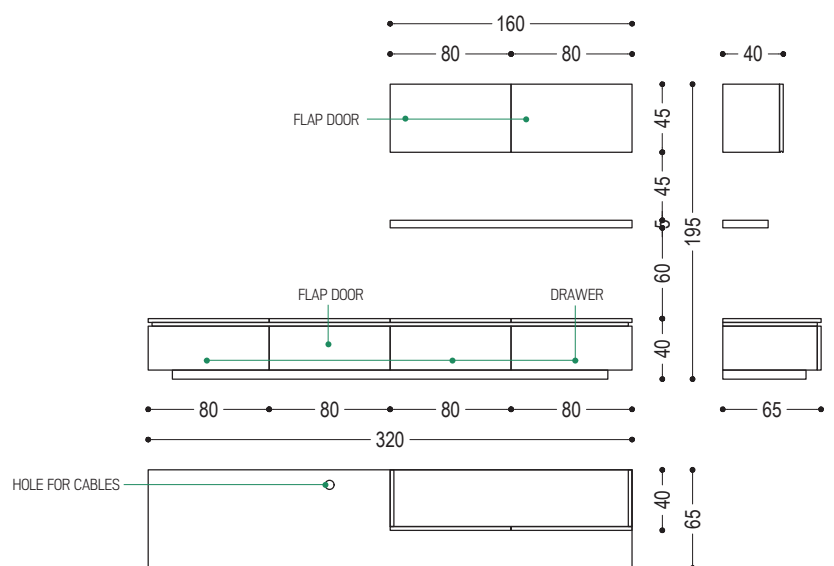

# SIPARIO 2011

## HOLE AND SYSTEM FOR TV-CABLES, ALUMINIUM COLOUR

FR - CV1 : Ø 6,6 cm



BACK

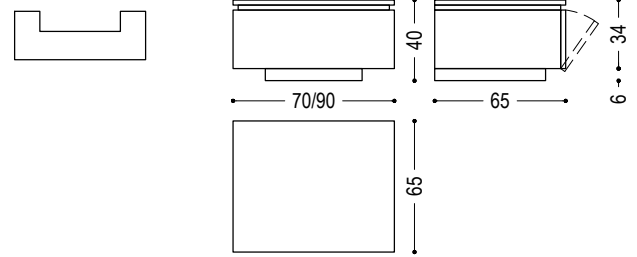

FEASIBILITY DOOR OPTIONS	W.70 cm	W.80 cm	W.90 cm
C			
E3			

### AVAILABLE FINISHES:

**C:** concrete: beige, grey, medium grey, black

**E3:** lacquered glass (only selected RAL colours)

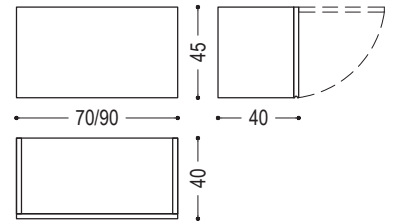

FEASIBILITY ADDITIONAL INTERNAL SHELF	
A1	
A2	
A3	
A5	

### AVAILABLE FINISHES:

**A1:** walnut without knots, walnut with knots, elm

**A2:** oak without knots, oak with knots, cherry, maple

**A3:** oak without knots finish: whitened, mystic black, neutro  
oak with knots finish: whitened, mystic black, neutro

**A5:** oak: with knots tabacco

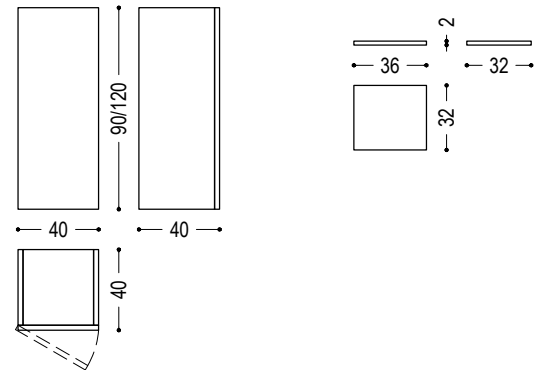

# SIPARIO 2011

## SIPARIO 2011 SHELF

CODE	SIZE	A1	A2	A3	A4	A5
SIPARIO MENS- 100	W.100 x D.30 x H.5	■	■	■	■	■
SIPARIO MENS- 120	W.120 x D.30 x H.5	■	■	■	■	■
SIPARIO MENS- 140	W.140 x D.30 x H.5	■	■	■	■	■
SIPARIO MENS- 160	W.160 x D.30 x H.5	■	■	■	■	■
SIPARIO MENS- 180	W.180 x D.30 x H.5	■	■	■	■	■
SIPARIO MENS- 200	W.200 x D.30 x H.5	■	■	■	■	■
SIPARIO MENS- 220	W.220 x D.30 x H.5	■	■	■	■	■
SIPARIO MENS- 240	W.240 x D.30 x H.5	■	■	■	■	■
SIPARIO MENS- 70	W.70 x D.30 x H.5	■	■	■	■	■
SIPARIO MENS- 80	W.80 x D.30 x H.5	■	■	■	■	■
SIPARIO MENS- 90	W.90 x D.30 x H.5	■	■	■	■	■

### AVAILABLE FINISHES:

**A1:** walnut without knots, walnut with knots, elm

**A2:** oak without knots, oak with knots, cherry, maple

**A3:** oak without knots finish: whitened, mystic black, neutro

oak with knots finish: whitened, mystic black, neutro

**A4:** oak without knots pigmented: ash grey, white milk, total black

oak with knots pigmented: ash grey, white milk, total black

N.B.: pigmented surfaces only outside, inside oak

**A5:** oak: with knots tabacco

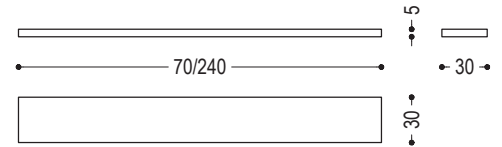

## WOOD

A1



walnut without knots



walnut with knots



elm

A2



oak without knots



oak with knots



cherry



maple

A3



oak without knots finish:  
whitened



oak without knots finish:  
mystic black



oak without knots finish:  
neutro



oak with knots finish:  
whitened



oak with knots finish:  
mystic black



oak with knots finish:  
neutro

A4



oak without knots pigmented:  
ash grey



oak without knots pigmented:  
white milk



oak without knots pigmented:  
total black

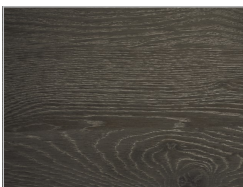

oak with knots pigmented:  
ash grey



oak with knots pigmented:  
white milk



oak with knots pigmented:  
total black

A5



oak:  
with knots tabacco

# PIECES OF FURNITURE | TECHNICAL NOTES

## DOORS AND DRAWERS OPENING SYSTEM

Add the following surcharge in case of non-standard opening system for drawers and doors.

SURCHARGE (price for one door/drawer)	
push-pull system	■
grooved handle	■

## CUTLERY TRAY

Trays can be customized upon request: feasibility and surcharge need to be confirmed by our sales department.  
Available finishes: walnut, oak, cherry, maple and elm.

CUTLERY DIVIDERS	
PP001 - for drawer W. 30 cm	■
PP002 - for drawer W. 60 cm	■
PP003 - for drawer W. 90 cm	■

**N.B.:**

Cutlery dividers laid in the drawer.

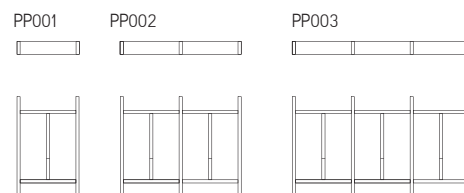

CUTLERY TRAY	
PP004 - for drawer W. 30 cm	■
PP005 - for drawer W. 60 cm	■
PP006 - for drawer W. 90 cm	■

**N.B.:**

Cutlery tray with lateral handles for easy use.

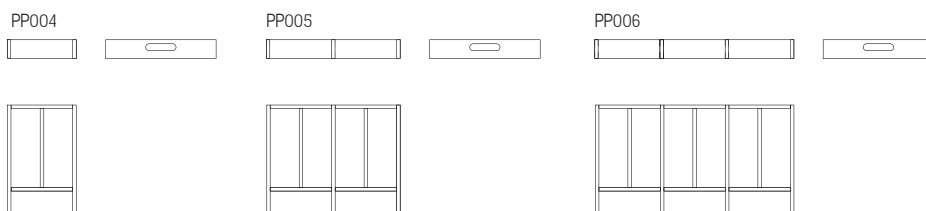

CUTLERY TRAY WITH CUTTING BOARD	
PPT001 - for drawer W. 60 cm	■

**N.B.:**

Cutlery tray with lateral handles for easy use, composed by: cutlery dividers, beech cutting board and knives holder.

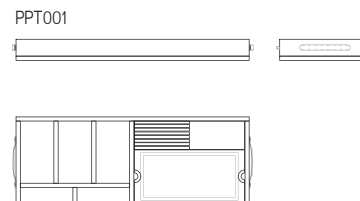

TRAY FOR FAR EAST ACCESSORIES	
SS001 - for drawer W. 60 cm	■

**N.B.:**

Set with dividers for far east kitchen with lateral handles for easy use.



## DRAWER DIVIDERS

### WINE SET

Set for drawer with accessories for wine tasting (professional corkscrew, spare tips, steel cap, thermometer, pourer, drip ring, foil cutter).

Size W.29,5 x D.22,5 cm.

WINE SET	
walnut/oak	■
teak	■



### SPIRITS SET

Set for drawer with accessories for spirits tasting (4 small glasses and 4 marble chilling cubes).

Size W.20 x D.22,5 cm.

SPIRITS SET	
walnut/oak	■



## BOTTLE SPACES

Wooden grid for space with size W.56 x H.35 cm; depth of the grid around 33 cm.

Characterized by 9 spaces around 9x9 cm each, for bottles positioned horizontally, and one vertical module around W.19 x H.31 cm.

The grid can be customized upon request: feasibility and surcharge to be confirmed by our sales department.

BOTTLE SPACES	
walnut/oak	■



## GLASS HOLDERS

Composed by 3 stainless steel holders.

Holders L. 32 cm can hold max. 3 glasses with diameter of 8,5 cm, while holders L. 46,6 cm max. 4 glasses.

This set needs to be fixed to the top shelf or to another fixed shelf.

For more details please check the technical drawing.

Upon request:

- available in other sizes.
- position of the 3 elements at different distance.

GLASS HOLDERS	
set 3 elements L.32 cm	■
set 3 element L.46,6 cm	■

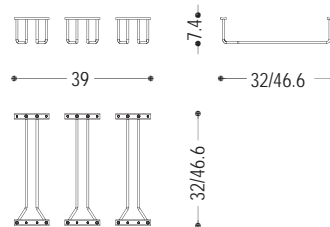

GLASS HOLDER ELEMENTS





## CONCRETE

C



concrete:  
beige



concrete:  
grey



concrete:  
medium grey



concrete:  
black

## GLASS

E3



lacquered glass - 5022\_NIGHT BLUE



lacquered glass - 7004\_SIGNAL GREY



lacquered glass - 7013\_BROWN GREY

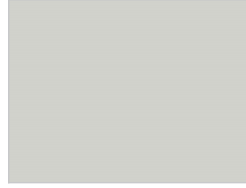

lacquered glass - 7035\_LIGHT GREY

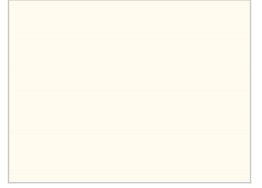

lacquered glass - 9010\_PURE WHITE



lacquered glass - 9011\_GRAPHITE BLACK