

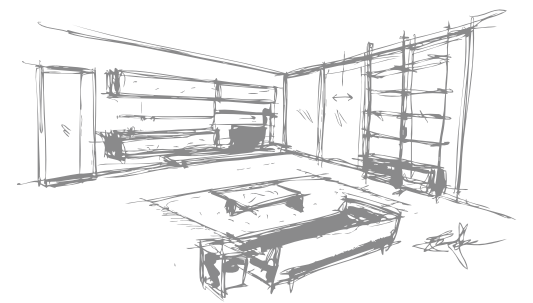

FEELING**Home**



Design | FRANCO DRIUSSO

Switch off

Start **Feeling...**



FEELINGHome

FEELINGHome

Arrital si impegna a **tutelare l'ambiente** con scelte sostenibili sia relativamente ai **materiali riciclabili** elaborati per i prodotti, sia alla loro **tecnologia**.

Arrital is committed to **protecting the environment** through sustainable choices both in terms of **recyclable materials** used for the products and their **technology**.



Richiedi prodotti certificati FSC®
Upon request are available products with FSC® certification



I prodotti in truciolare scelti, Fundermax e Cleaf garantiscono:

- Applicazione dei bordi tramite **colla poliuretanica**
- **Certificazione P3** per una migliore idrorepellenza
- **Certificazione Carb Phase II Compliant EPA TSCA titolo VI** per la massima riduzione all'emissione di Formaldeide
- **Certificazione FSC** per la provenienza del legname da foreste certificate
- **Pannelli** realizzati con **truciolare vergine riciclabile**

The selected particle boards panel, **Fundermax** and **Cleaf**, guarantee the:

- Edge banding with **polyurethane glue**
- **P3 Certification** for improved water repellency
- **Carb Phase II Compliant EPA TSCA title VI certification** for maximum reduction in Formaldehyde emissions
- **FSC certification** for wood sourced from certified forests
- **Panels** made of **recyclable virgin particle board**

Lo spazio di vita ibrido, oltre la cucina
A life space beyond the kitchen

Arrital designs and interprets living open spaces beyond the kitchen, where users and their lives are the real protagonists. Kitchens become the theatre representing design and emotions of a dynamic habitat, where new functions and relations blend together. The style of the living area becomes a mood for sharing, that expresses the personality of the home and those who live it.

Feeling Home, a systematic, tailored and flexible project to transform space into quality, well-being and pleasure.

The concept is well-represented by **k_Lounge**, a program of solutions and modular compositions for the living area where technology and purpose are integrated in balance with design and matheria. Along with **Feeling Home**, Arrital also presents a collection of **complements** which enhance the essence of the environment, turning it into a project with unique style.

Arrital progetta ed interpreta lo spazio aperto del giorno oltre la cucina, mettendo al centro l'utente e la vita. Le nuove funzioni, il lavoro e le relazioni in un contesto ibrido, con la cucina come teatro di rappresentazione del design e delle emozioni nell'habitat dinamico.

Lo stile del giorno diventa mood di condivisione, per esprimere la personalità della casa e di chi la vive. **Feeling Home**, un progetto organico, personalizzato e flessibile, per trasformare lo spazio in qualità, benessere, piacere.

Un concetto che include anche **k_Lounge** un programma di soluzioni e composizioni con modularità dedicate per l'area del giorno, dove tecnologia e funzione si integrano in equilibrio con design e materia. Con **Feeling Home** Arrital presenta inoltre una collezione di **Complementi** che amplificano il valore dell'ambiente trasformandolo in un progetto dallo stile unico.

FEELING**Home**

_kLounge: Integrated systems | **_08_49**

_Complements | **_50_113**

_Tables and Chairs | **_114_151**

_kL_01



Smoke | Melaminico Termostrutturato Porò Registro
Lithos | Melaminico Termostrutturato Materico

_kL_02



Metal Grafite | Laccato Metal

_kL_03



Cloud | Melaminico Termostrutturato Texture
Moro | Melaminico Termostrutturato Sabbiato

_kL_04



Pepper | Olmo Sabbiato
Ardesia | Laccato Sand

_kL_05



Metal Flame | Laccato Metal
Fumè | Eucalipto Sabbiato

_kL_06



Noce Light | Melaminico Termostrutturato Sabbiato
Nero Ingo | Fenix Ntm®

| | |
|--------|--------|
| _kL_01 | _10_15 |
| _kL_02 | _16_21 |
| _kL_03 | _22_27 |
| _kL_04 | _28_35 |
| _kL_05 | _36_43 |
| _kL_06 | _44_49 |

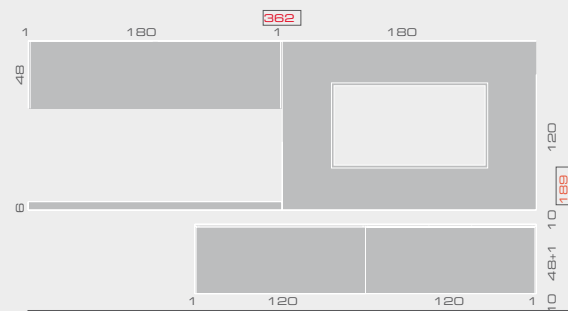

DETTAGLI
DETAILS - DÉTAILS - DETALLES

Barra elettrificata LETROH - LETROH electrified bar
Barre électrifiée LETROH - Barra eletrificada LETROH

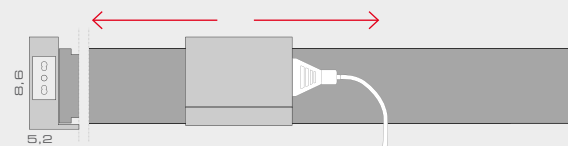

Gruppo prese elettriche - Electrical socket group
Groupe de prises électriques - Grupo de enchufes eléctricos

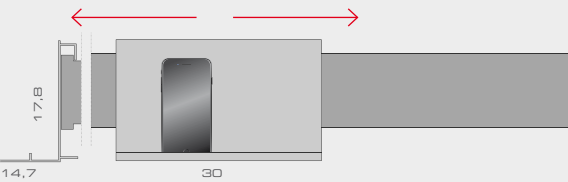

Mensola - Shelf - Étagère - Estante

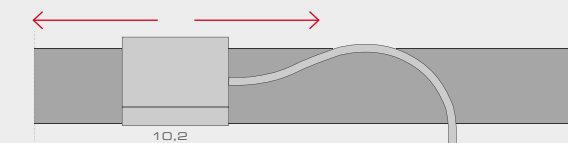

NUO luce - Light NUO - NUO lumière - NUO ligero

DIMENSIONI
DIMENSIONS - TAILLE - TALLA

PENSILI - WALL UNITS - MEUBLES HAUTS - COLGANTES
L-W 180 cm - H-H 48 cm - P-D 34,2 cm

BASI - BASE UNITS - ELEMENTS BAS - BAJOS
L-W 120 cm - H-H 48 cm - P-D 51 cm

SCHIENALE PORTA TV - TV STAND BACK PANEL
PANNEAU ARRIÈRE PORTE-TV - RESPALDO PORTA TV
L-W 180 cm - H-H 120 cm - P-D 10,2 cm

MENSOLA - SHELF - ÉTAGÈRE - ESTANTE
L-W 182 cm - H-H 6 cm - P-D 44,2 cm

APERTURA
OPENING - OUVERTURE - APERTURA

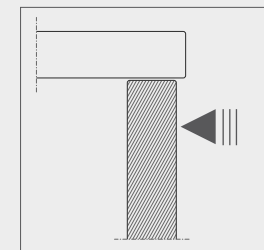

PUSH PULL

FINITURE
FINISHES - FINITIONS - ACABADOS

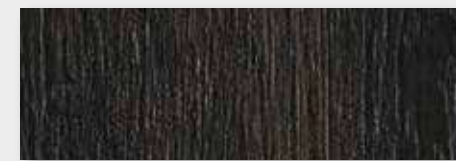

Smoke | Melaminico Termostrutturato Poro Registro



Lithos | Melaminico Termostrutturato Materico







Cucina e Living dialogano attraverso le stesse finiture e nuances cromatiche.

La composizione **_kL_01** offre un comodo spazio scrittoio (home-office) grazie al piano sospeso **Plank** solidamente ancorato a parete.

I moduli **K_Lounge** sono predisposti per ospitare gli accessori necessari per il relax multimediale, come TV, decoder, consolle, ecc. grazie agli accessori passacavi e ripiani scorrevoli dedicati. Il pannello **Display** porta TV, previsto in diverse dimensioni e configurazioni, consente di ospitare schermi fino a 50".

La barra elettrificata **Letroh**, con accessori e prese elettriche mobili completa funzionalmente l'area studio.

Kitchen and Living areas are linked by the same finishes and colour nuances.

The **_kL_01** composition provides a convenient desk space (home-office) thanks to the wall-mounted **Plank** desk top.

The **k_Lounge** modules are designed to house all the accessories required for multimedia relax, such as the TV, decoder, and console, etc. thanks to the wireways sliding shelves.

Display TV panel, available in different sizes and configurations, is arranged for screens up to 50".

Letroh power bar, with accessories and moveable electrical sockets, completes the functional layout of the area.

Cuisine et Living dialoguent à travers les mêmes finitions et nuances de couleur.

La composition **_kL_01** offre un espace bureau pratique (home-office) grâce au plateau suspendu **Plank** solidement fixé au mur.

Les modules **k_Lounge** sont prédisposés pour accueillir les accessoires nécessaires au relax "multimédia", comme la TV, le decoder, la console, etc. grâce aux accessoires passe-fils et tablettes coulissantes dédiés.

Le panneau **Display** porte-TV, disponible en plusieurs dimensions et configurations, permet d'accueillir des écrans allant jusqu'à 50".

Le rail électrique **Letroh**, avec ses accessoires et prises électriques mobiles, complète fonctionnellement l'espace bureau.

Cocina y Living dialogan a través de los mismos acabados y nuances cromáticos.

La composición **_kL_01** ofrece un cómodo espacio escritorio (home-office) gracias a la encimera suspendida **Plank** y sólidamente anclada en la pared.

Los módulos **k_Lounge** están preparados para albergar los accesorios necesarios para el relax multimedia, como TV, decoder, consolle, etc. gracias a los accesorios pasacables y a los estantes deslizantes.

El panel **Display** porta TV, previsto en diversos tamaños y configuraciones, permite albergar pantallas de hasta 50".

La barra electrificada **Letroh**, con accesorios y tomas eléctricas móviles completa funcionalmente el área estudio.



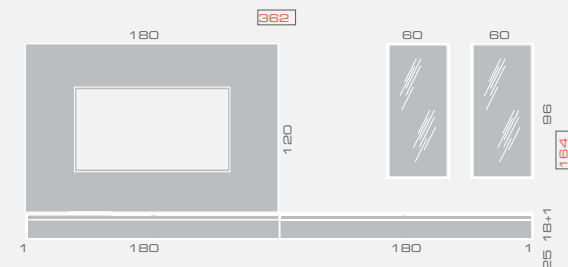

DETTAGLI
DETAILS - DÉTAILS - DETALLES

Passaggio cavi - Wireway
Passage des câbles - Paso de cable

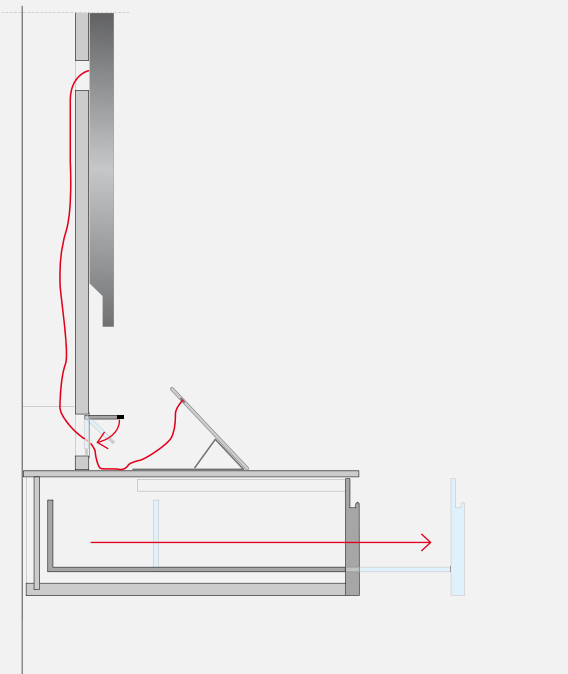
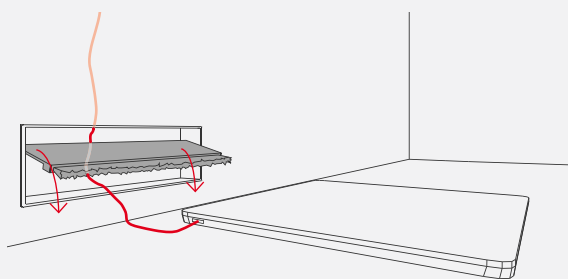

DIMENSIONI
DIMENSIONS - TAILLE - TALLA

BASI - BASE UNITS - ELEMENTS BAS - BAJOS
L-W 180 - H-H 18 - P-D 51

SCHIENALE PORTA TV - TV STAND BACK PANEL
PANNEAU ARRIERE PORTE-TV - RESPALDO PORTA TV
L-W 180 - H-H 120 - P-D 10,2

PENSILI GEM - "GEM" WALL UNITS - MEUBLES HAUTS
"GEM" - COLGANTES "GEM"
L-W 60 - H-H 96 - P-D 38

APERTURA
OPENING - OUVERTURE - APERTURA

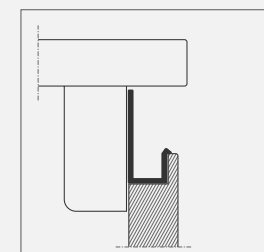

COVER-UP

FINITURE
FINISHES - FINITIONS - ACABADOS



Metal Grafite | Laccato Metal







La porta **Pass System**, nell'immagine, dotata di maniglia O97, diventa prezioso diaframma tra lo spazio cucina e il living o altri ambienti della casa.

Il pannello **Display** porta TV, dotato di illuminazione perimetrale LED a luce calda, contribuisce al corretto livello luminoso dell'ambiente per la visione dello schermo.

Pass System door, shown here with O97 handle, acts as an elegant passageway between the kitchen and living space or other rooms of the home. Display TV panel with warm backlit LED lighting, provides a proper lighting in the room for watching television.

La porte **Pass System**, dans l'image, dotée d'une poignée O97, devient une belle séparation entre l'espace cuisine et le séjour ou d'autres espaces de la maison. Le panneau **Display** porte-TV, doté d'un éclairage LED à lumière chaude, contribue à obtenir un niveau lumineux adéquat de l'espace pour la vision de l'écran.

La puerta **Pass System**, en la imagen, dotada de tirador O97, se convierte en un precioso diafragma entre el espacio cocina y el living u otros ambientes de la casa. El panel **Display** porta TV, dotado de iluminación perimetral LED con luz cálida, contribuye al correcto nivel luminoso del ambiente para la visión de la pantalla.

L'equilibrio cromatico caratterizza la composizione **_kL_02**, le basi sospese sono dotate di maniglia **Cover-Up** con profilo brunito ed inserto in tinta con l'anta. Le vetrine pensili **Gem** lasciano scorgere, dietro l'elegante vetro fumè, i ripiani in vetro illuminati.

The colour balance is a key feature of the **_kL_02** composition, the wall-mounted base units feature the **Cover-Up** handle with Brunito profile and insert in the same colour as the door. **Gem** wall units provides a glimpse of the illuminated glass shelves behind the elegant fumè glass doors.

L'équilibre chromatique caractérise la composition **_kL_02**, les meubles bas suspendus sont dotés d'une poignée **Cover-Up** avec un profil Brunito et insert de la même couleur que la porte. Les vitrines hautes **Gem** laissent apercevoir, derrière l'élégante vitre fumè, les tablettes en verre éclairées.

El equilibrio cromático caracteriza la composición **_kL_02**, las bases suspendidas están dotadas de tirador **Cover-Up** con perfil Brunito e inserto del color de la puerta. Las vitrinas colgantes **Gem** dejan divisar, tras el elegante vidrio fumè, los estantes en vidrio iluminados.



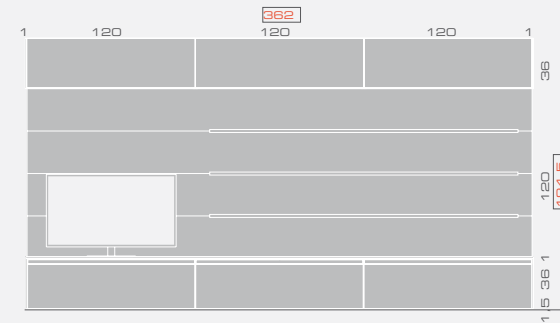

DETTAGLI
DETAILS - DÉTAILS - DETALLES

Piani estraibili - Sliding shelves
Tablettes amovibles - Estanterías extraíbles

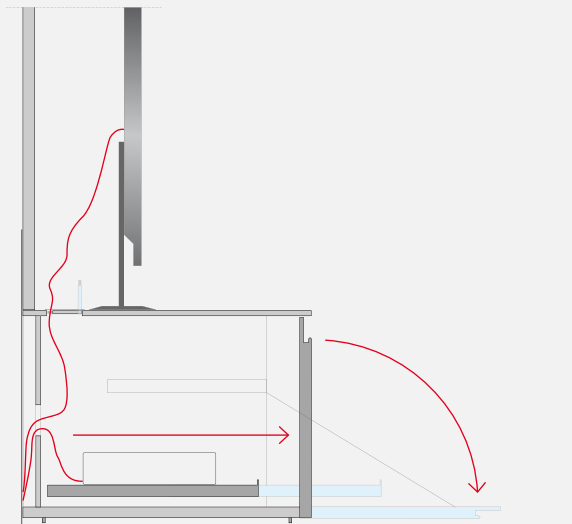
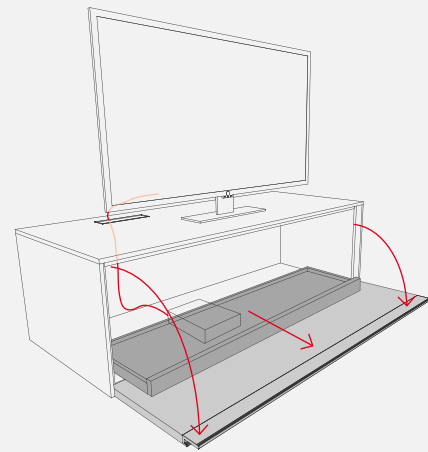

DIMENSIONI
DIMENSIONS - TAILLE - TALLA

PENSILI - WALL UNITS - MEUBLES HAUTS - COLGANTES
L-W 120 cm - H-H 36 cm - P-D 36,7 cm

BASI - BASE UNITS - ELEMENTS BAS - BAJOS
L-W 120 cm - H-H 36 cm - P-D 51 cm

BOISERIE - BOISERIE - BOISERIE - BOISERIE
L-W 360 cm - H-H 120 cm - P-D 4 cm

MENSOLE - SHELF - ÉTAGÈRES - ESTANTES
L-W 220 cm - H-H 1 cm - P-D 20 cm

APERTURA
OPENING - OUVERTURE - APERTURA

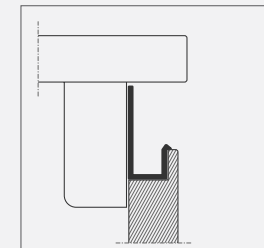

COVER-UP

FINITURE
FINISHES - FINITIONS - ACABADOS



Cloud I Melaminico Termostrutturato Texture

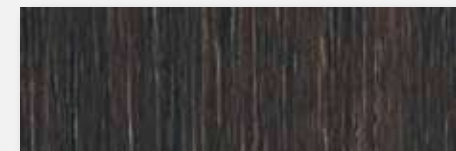

Moro I Melaminico Termostrutturato Sabbiato







Estetica e funzione contraddistinguono la composizione **_kL_03**: la finitura Cloud è disponibile per ante, piano e fusto dei mobili; le comode basi con apertura a ribalta contengono i ripiani scorrevoli estraibili per facilitare l'accesso ai cablaggi dei vari devices. La composizione viene completata dal tavolo **Nice** in finitura laminato moro e le sedie **Queeny** con scocca nera e sedile in paglia naturale. Inoltre i tavolini **Loft**, disponibili in finitura con le ante, offrono pratiche superfici di appoggio nell'area Living.

Aesthetic appeal and practicality are the hallmarks of the **_kL_03** composition: the Cloud finish is available for the doors, top and carcass; base units with flap-down door house pull-out sliding shelves for easy access to the cables of the various devices. The composition is completed by the **Nice** table in a dark brown laminate finish and the **Queeny** chairs with a black body and natural straw seat. The **Loft** coffee tables, available in the same finish as the doors, provide practical surfaces to place objects in the Living room area.

Esthétique et fonction caractérisent la composition **_kL_03**: la finition Cloud est disponible pour les portes, le plateau et la structure des meubles; les meubles bas très pratiques, à ouverture basculante, contiennent les tablettes coulissantes amovibles pour faciliter l'accès aux câbles des différents devices. La composition est complétée par la table **Nice** en finition stratifié brun et les chaises **Queeny** à structure noire et assise en paille naturelle. Les tables basses **Loft**, disponibles dans la même finition que les portes, offrent des surfaces d'appui pratiques dans l'espace Living.

Estética y función distinguen la composición **_kL_03**: el acabado Cloud está disponible para puertas, encimera y base de los muebles; las cómodas bases con apertura abatible contienen los estantes deslizantes extraíbles para facilitar el acceso a los cableados de los distintos devices. La composición se completa con la mesa **Nice** en acabado laminado marrón y las sillas **Queeny** con estructura negra y asiento en paja natural. Además las mesitas **Loft**, disponibles en acabado con las puertas, ofrecen prácticas superficies de apoyo en el área Living.



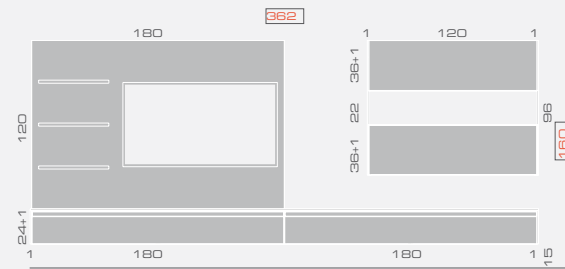

DETTAGLI
DETAILS - DÉTAILS - DETALLES

Ribalta superiore e inferiore - Upper and lower flap door
Porte relevable supérieur et inférieur - Puerta abatible superior et inferior

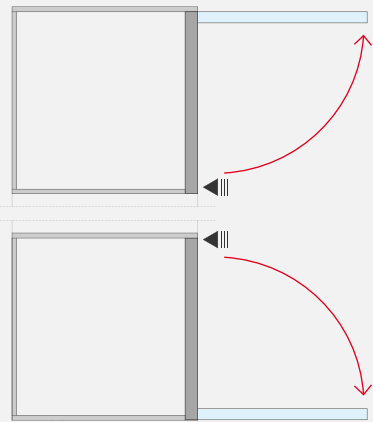
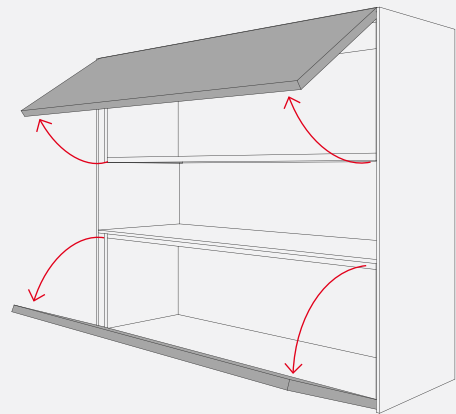

DIMENSIONI
DIMENSIONS - TAILLE - TALLA

PENSILI - WALL UNITS - MEUBLES HAUTS - COLGANTES
L-W 180 cm - H-H 36 cm - P-D 36,7 cm

BASI - BASE UNITS - ELEMENTS BAS - BAJOS
L-W 180 cm - H-H 24 cm - P-D 51 cm

SCHIENALE PORTA TV - TV STAND BACK PANEL
PANNEAU ARRIÈRE PORTE-TV - RESPALDO PORTA TV
L-W 180 cm - H-H 120 cm - P-D 10,2 cm

MENSOLE - SHELFs - ÉTAGÈRES - ESTANTES
L-W 50 cm - H-H 2,2 cm - P-D 25 cm

APERTURA
OPENING - OUVERTURE - APERTURA

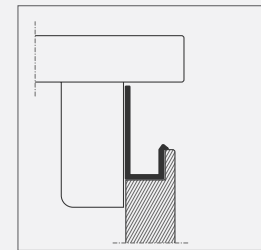

COVER-UP

FINITURE
FINISHES - FINITIONS - ACABADOS



Pepper | Olmo Sabbieto

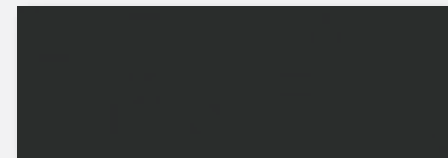

Ardesia | Laccato Sand







Composizione con **pensili** sospesi in laccato Ardesia con apertura push-pull.
 Le **basi**, con apertura tramite maniglia Cover-Up, sono organizzate con moduli a cassetto e moduli a ribalta con ripiani interni estraibili per aumentarne la praticità di utilizzo.

La **base** in finitura Olmo Pepper viene dotata di accessorio passacavi per facilitare il passaggio dei cavi.

Il pannello **Display** retroilluminato a LED sul perimetro con luce calda, completa la composizione.

Composition with **wall units** lacquered in Ardesia with push-pull opening.
 The **base units**, with Cover-Up handle, are organised with drawer units and flap-down door modules with pull-out internal shelves to make them even more practical.

The **base unit** in the Olmo Pepper finish has a wireway to ease the arrangements of the cables.

Display panel, with warm backlit LED lighting, adds the finishing touch to the composition.

Composition avec **meubles hauts** suspendus laqués Ardesia à ouverture push-pull. Les **meubles bas**, qui s'ouvrent avec la poignée Cover-Up, sont organisés avec des modules à tiroirs et des modules basculants, avec des tablettes amovibles à l'intérieur pour augmenter leur côté pratique.

Le **meuble bas** en finition Olmo Pepper est doté d'accessoires passe-fils pour faciliter le passage des câbles.

Le panneau **Display** rétroéclairé à LED sur le périmètre avec une lumière chaude, complète la composition.

Composición con **colgantes suspendidos** en lacado Ardesia con apertura push-pull. Las **bases**, con apertura mediante tirador Cover-Up, están organizadas con módulos de cajón y módulos abatibles con estantes internos estraibles para aumentar la practicidad de uso.

La **base** en acabado Olmo Pepper está dotada de accesorio pasacables para facilitar el paso de los mismos.

El panel **Display** retroiluminado con Led en el perímetro con luz cálida, completa la composición.





_KL_05

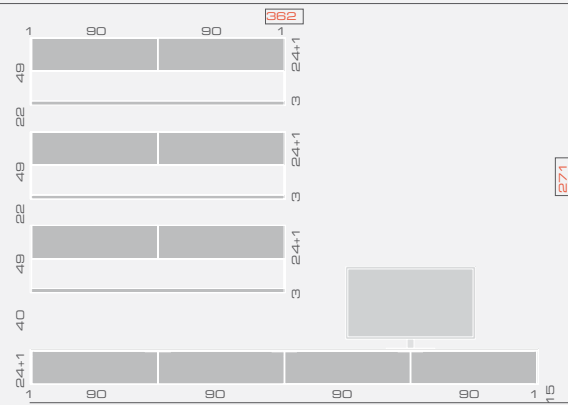

DETTAGLI
DETAILS - DÉTAILS - DETALLES

Passaggio cavi - Wireway
Passage des câbles - Paso de cable

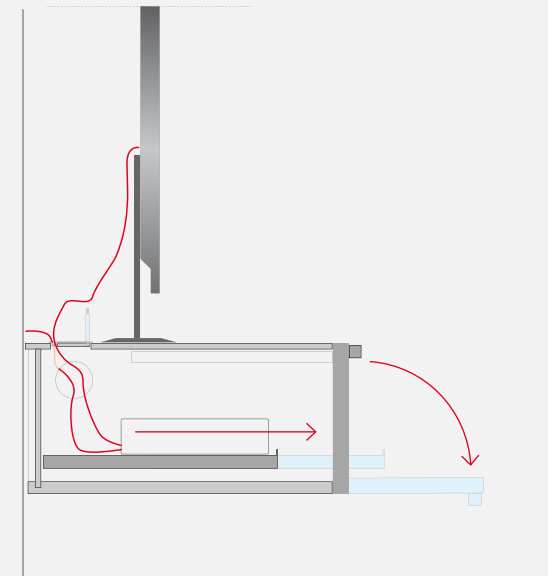
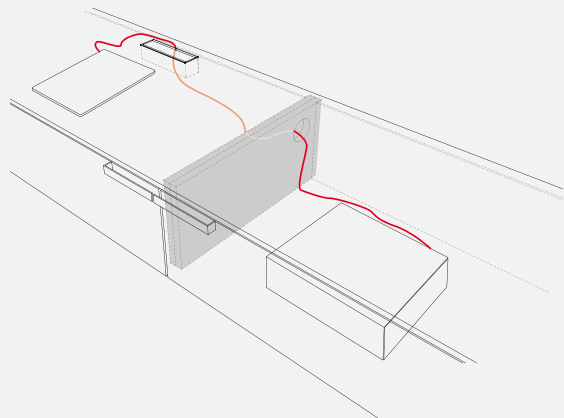

DIMENSIONI
DIMENSIONS - TAILLE - TALLA

PENSILI - WALL UNITS - MEUBLES HAUTS - COLGANTES
L-W 180,2 cm - H-H 24 cm - P-D 36,7 cm

BASI - BASE UNITS - ELEMENTS BAS - BAJOS
L-W 90 cm - H-H 24 cm - P-D 51 cm

APERTURA
OPENING - OUVERTURE - APERTURA

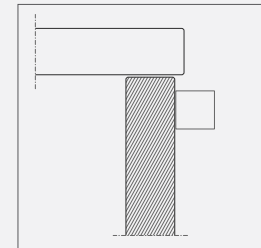

HEM

FINITURE
FINISHES - FINITIONS - ACABADOS



Metal Rame | Laccato Metal



Fumè | Eucalipto Sabbiato

FEELINGHome







Composizione con **pensili** sospesi in essenza Eucalipto Fumè con apertura push-pull e dotati di illuminazione Led.

Le **basi** in finitura laccato Metal Rame presentano la nuova maniglia 095.

Il piano **Plank** impiallacciato in Eucalipto Fumè e la boiserie Strato organizzano lo spazio relax con finalità home/office.

Composition with **wall units** in the Eucalipto Fumè wood finish with push-pull opening system, featuring LED lighting.

The **base** units in the Metal Rame lacquered finish showcase the new 095 handle.

The veneered **Plank** top in Eucalipto Fumè and the boiserie Strato organise the relaxation area for home/office use.

Composition avec **meubles hauts** suspendus en essence Eucalyptus Fumè à ouverture push-pull et dotés d'un éclairage Led.

Les **meubles bas** en finition laqué Metal Rame présentent la nouvelle poignée 095.

Le plateau **Plank** contreplaqué en Eucalyptus Fumè et la boiserie Strato organisent l'espace détente avec des finalités home/office.

Composición con **colgantes suspendidos** en esencia Eucalipto Fumè con apertura push-pull y dotados de iluminación Led.

Las **bases** en acabado lacado Metal Rame presentan el nuevo tirador 095.

La encimera **Plank** contrachapada en Eucalipto Fumè y la boiserie Strato organizan el espacio relax con fines home/office.





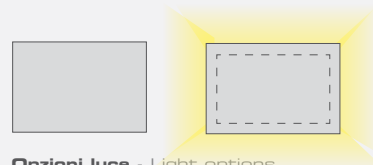

Opzioni luce - Light options
Options d'éclairage - Opciones de luz

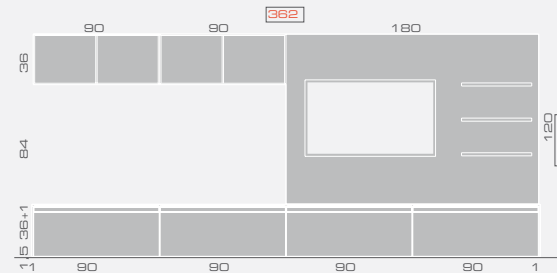

DETTAGLI
DETAILS - DÉTAILS - DETALLES

Retroilluminazione - Backlight
Rétroéclairage - Iluminar desde el fondo

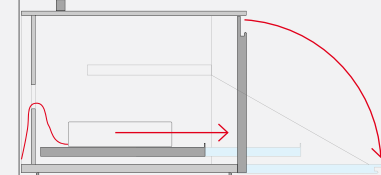
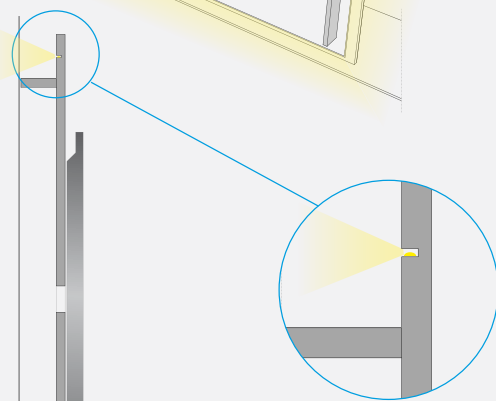
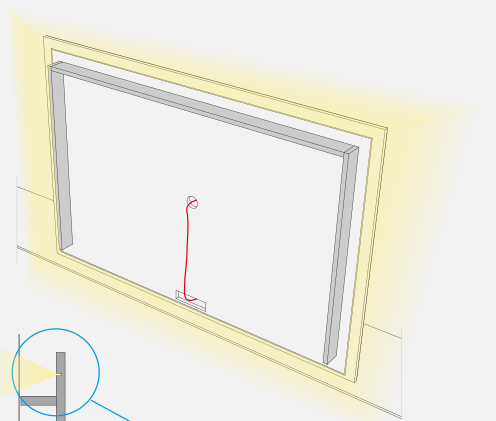

DIMENSIONI
DIMENSIONS - TAILLE - TALLA

VANI A GIORNO - OPEN UNITS
NICHES OUVERTES - HUECOS ABIERTOS
L-W 90 cm - H-H 36 cm - P-D 36,7 cm

BASI - BASE UNITS - ELEMENTS BAS - BAJOS
L-W 90 cm - H-H 36 cm - P-D 51 cm

SCHIENALE PORTA TV - TV STAND BACK PANEL
Panneau Arrière Porte-TV - Respaldo Porta TV
L-W 180 cm - H-H 120 cm - P-D 10,2 cm

MENSOLE - SHELFs - ÉTAGÈRES - ESTANTES
L-W 50 cm - H-H 2,2 cm - P-D 25 cm

APERTURA
OPENING - OUVERTURE - APERTURA

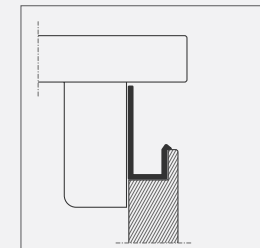

COVER-UP

FINITURE
FINISHES - FINITIONS - ACABADOS



Noce Light | Melaminico Termostrutturato Sabbieto

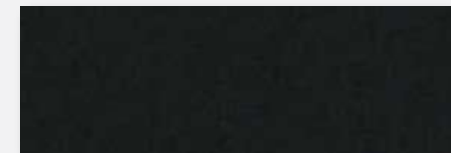

Nero Ingo | Fenix Ntm®







La composizione **_kL_06** si compone con **basi**, pannello **Display** e **vani a giorno** sospesi. Le ante della basi hanno maniglie Cover-Up e vengono dotate di vassoi scorrevoli che facilitano l'utilizzo degli spazi interni. Il pannello **Display** porta TV in finitura Fenix Ntm® Nero Ingo viene evidenziato dal suggestivo giroluce LED perimetrale. Lo spazio domestico viene completato dal tavolo **Nice** anch'esso in finitura Fenix Ntm® Nero Ingo e dalle sedie **Color** laccate Nero opaco.

The **_kL_06** composition consists of **base units**, **Display** panel and wall-mounted open compartments. The doors of the base units have Cover-Up handles and feature sliding shelves for easy access to the interior. The TV stand **Display** panel in Fenix Ntm® Nero Ingo finish is highlighted by the eye-catching LED lights on the outer edge. The home setting is completed by the **Nice** table, also featured in the Fenix Ntm® Nero Ingo finish and the **Color** chairs in matt lacquered Nero.

La composition **_kL_06** se compose de **meubles bas**, d'un panneau **Display** et de niches ouvertes suspendues. Les portes du meuble bas ont des poignées Cover-Up et sont dotées de plateaux coulissants qui facilitent l'utilisation des espaces intérieurs. Le panneau **Display** porte-TV en finition Fenix Ntm® Nero Ingo est mis en relief par l'éclairage LED périmétrique. L'espace domestique est complété par la table **Nice** elle-aussi en finition Fenix Ntm® Nero Ingo et par les chaises **Color** laquées Nero mat.

La composición **_kL_06** se realiza con **bases**, panel **Display** y compartimentos abiertos suspendidos. Las puertas de las bases tienen tiradores Cover-Up y están equipadas con bandejas deslizantes que facilitan el uso de los espacios internos. El panel **Display** porta TV en acabado Fenix Ntm® Nero Ingo se destaca por la sugestiva iluminación LED perimetral. El espacio doméstico se completa con la mesa **Nice** también en acabado Fenix Ntm® Nero Ingo y con las sillas **Color** lacadas Nero opaco.



_Complements

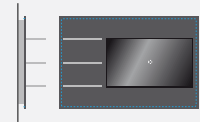

Display



Shangai

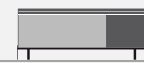

Kontena



Mensola "T"

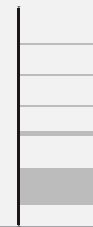

Vertical

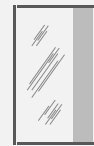

Mirror System



Ak_Winery



Pass System

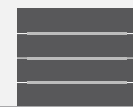

Boiserie Strato



Plank

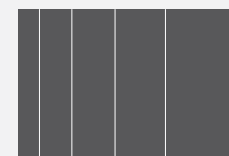

Planar/Free



Basket

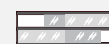

AkB_Case

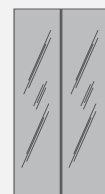

Gem



DayBox

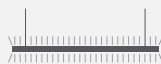

Lympa

| | |
|-----------------|----------|
| Display | _52_53 |
| Kontena | _54_61 |
| Vertical | _62_69 |
| Ak_Winery | _70_71 |
| Boiserie Strato | _72_75 |
| Planar/Free | _76_77 |
| AkB_Case | _78_83 |
| DayBox | _84_87 |
| Shangai | _88_91 |
| Mensola "T" | _92_93 |
| Mirror System | _94_97 |
| Pass System | _98_101 |
| Plank | _102_103 |
| Basket | _104_105 |
| Gem | _106_111 |
| Lympa | _112_113 |

Display



Finiture Finishes:

Melaminico
Fenix Ntm®
Laminato HPL
Laccati: Lucidi/Sand, Soft-Touch, Ossidato e Metal
Legni: Rovere spazzolato, Abete Tinto, Olmo sabbato,
Noce sabbato fumo, Noce Canaletto, Eucalipto
sabbato, Ebano opaco, Olivo opaco

Melamine
Fenix Ntm®
Laminato HPL
Laquered: Glossy/Sand, Soft-Touch, Oxidized, Metal
Woods: Rovere spazzolato, Abete Tinto, Olmo
sabbato, Noce sabbato fumo, Noce Canaletto,
Eucalipto sabbato, Ebano opaco, Olivo opaco

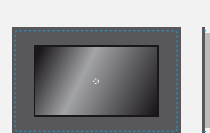

L-W 120 - 150 - 180 cm
H-H 96 - 120 cm
P-D 10,2 cm

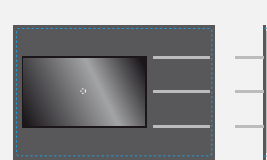

L-W 150 - 180 cm
H-H 96 - 120 cm
P-D 10,2 cm
Mensole Shelves L-W 50 x P-D 25 cm

FEELINGHome

Il pannello Display porta TV con passacavi viene realizzato in tre diverse larghezze e due altezze. Può essere attrezzato con mensole creando una parete d'arredo funzionale e contenitiva. Il pannello può anche essere realizzato con un sistema perimetrale di retroilluminazione a LED con luce calda 3000° K che garantisce un corretto livello luminoso per la visione del televisore.

Display TV Panel with wireway comes in three different widths and two heights. It can be fitted with shelves to create an attractive and functional storage wall. The panel can also be fitted with a LED backlighting system on the outer edge, generating warm 3000° K light, which ensures the correct level of lighting for watching television.

Le panneau Display porte-TV avec passe-fils est réalisé en trois largeurs et deux hauteurs différentes. Il peut être équipé d'étagères pour créer un complément d'ameublement mural fonctionnel et des rangements. Le panneau peut également être réalisé avec un système périmétrique de rétroéclairage à LED avec une lumière chaude 3000° K qui garantit un niveau lumineux adéquat pour la vision du téléviseur.

El panel Display porta TV con pasacables está realizado en tres diversos anchos y dos alturas. Puede equiparse con estantes para crear un mueble de pared funcional y contenedor. El panel puede realizarse también con un sistema perimetral de retroiluminación LED con luz cálida 3000° K que garantiza un correcto nivel luminoso para la visión del televisor.



Kontena



Finiture Finishes:

Melaminico
Fenix Ntm®, Fenix Nta®
Laccati: Soft-Touch, Ossidato, Metal, Lucidi/Sand
Laminato Hpl
Legni: Rovere spazzolato, Eucalipto sabbaiato,
Noce fumo sabbaiato, Noce Canaletto,
Olmo sabbaiato, Abete tinto, Ebano, Olivo,
Abete 1° patina

Melamine
Fenix Ntm®, Fenix Nta®
Laquered: Soft-Touch, Oxidized, Metal, Glossy/Sand
Laminare Hpl
Wood: Rovere spazzolato, Eucalipto sabbaiato,
Noce fumo sabbaiato, Noce Canaletto,
Olmo sabbaiato, Abete tinto, Ebano, Olivo,
Abete 1° patina

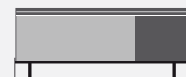

L-W 169,4 - 184,4 - 214,4 cm
H-H 65 - 68 - 85,5 - 88,5 cm
P-D 52,8 cm



L-W 109,4 cm
H-H 145 - 164 - 181 cm
P-D 52,8 cm

Nate dall'esigenza di contenere e dilatare lo spazio cucina, le madie Kontena, fanno della loro poliedricità il maggiore punto di forza. Proposte in tante misure e finiture, sono la congiunzione tra gli ambienti domestici.

Resulting from the need to increase storage space in the kitchen, the hallmark feature of the Kontena sideboards is their versatility. They are available in numerous sizes and finishes and create a link between rooms.

Nés du besoin de contenir et de dilater l'espace cuisine, les buffets Kontena, font de leur forme polyédrique leur point fort. Proposés dans de très nombreuses tailles et finitions, ils sont la conjonction entre les pièces de la maison.

Nacidos por la exigencia de contener y ampliar el espacio de la cocina, los aparadores Kontena, hacen de su versatilidad el mayor punto fuerte. Propuestos en muchos tamaños y acabados, son el nexo de unión entre los ambientes del hogar.





Kontena_1

Il design della madia Kontena_1 si contraddistingue dallo sviluppo orizzontale del complemento.
Oggetto d'arredo discreto ma dalla forte personalità, prevede una doppia apertura consentita dalla maniglia Cover-Up che riprende la finitura dell'anta

The signature design of the Kontena_1 sideboard is its horizontal layout.
An understated, yet stand-out furnishing accessory with a double opening using the Cover-Up handle, featured in the same finish as the door.

Le design du buffet Kontena_1 se caractérise par le développement horizontal du complément.
Objet d'ameublement discret mais à la forte personnalité, il prévoit une double ouverture possible grâce à la poignée Cover-Up qui reprend la finition de la porte.

El design del aparador Kontena_1 se distingue por el desarrollo horizontal del complemento.
Objeto mobiliario discreto pero de gran personalidad, prevé una doble apertura permitida por el tirador Cover-Up que retoma el acabado de la puerta.

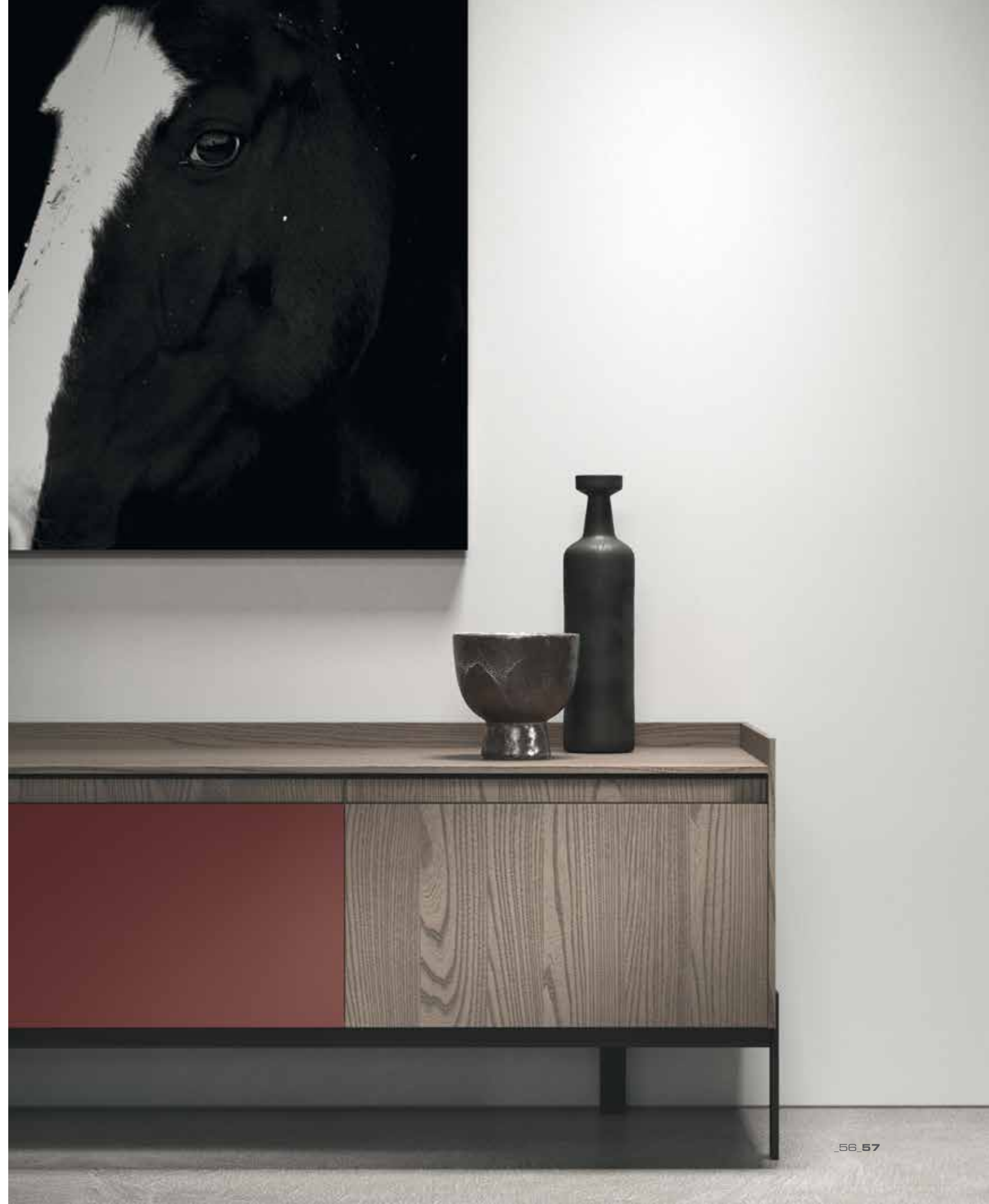



Kontena_2

Aumenta la volumetria del mobile che permette di organizzare al meglio i vani interni delle basi. L'illuminazione LED può essere presente nel meccanismo di apertura dei cestoni e dei cassetti.

It adds extra volume which allows for the optimal organisation of the inner compartments of the base units. LED lighting can be included in the opening mechanism of the drawers and deep drawers.

Augmente le volume du meuble qui permet de mieux organiser les compartiments intérieurs des meubles bas. L'éclairage LED peut être intégré dans le mécanisme d'ouverture des paniers et des tiroirs.

Aumenta la volumetría del mueble que permite organizar los compartimientos internos de las bases. La iluminación LED puede estar presente en el mecanismo de apertura de las cestas y de los cajones.





Kontena_3

Le attrezzature interne sono studiate per sfruttare al meglio lo spazio. Cassetti e ripiani creano ambiti di utilizzo precisi e puntuali. Particolare attenzione anche alla gradazione cromatica delle cerniere brunate che si armonizza al colore della scocca.

The internal accessories have been designed to make the most of the space. Drawers and shelves create precise and easily accessible areas of use.

Extra attention is also paid to the colour gradation of the burnished hinges which blend in with the colour of the carcass.

Les équipements intérieurs sont étudiés pour utiliser l'espace au maximum. Tiroirs et tablettes créent des contextes d'utilisation précis. Une attention particulière est également accordée à la gradation de couleur des charnières bruniées qui s'harmonise avec la couleur de la structure.

Los equipamientos internos están estudiados para aprovechar mejor el espacio. Los cajones y estantes crean zonas de uso precisas y específicas.

También se prestó especial atención a la gradación cromática de las bisagras bruñidas, que armoniza con el color de la estructura.

Vertical

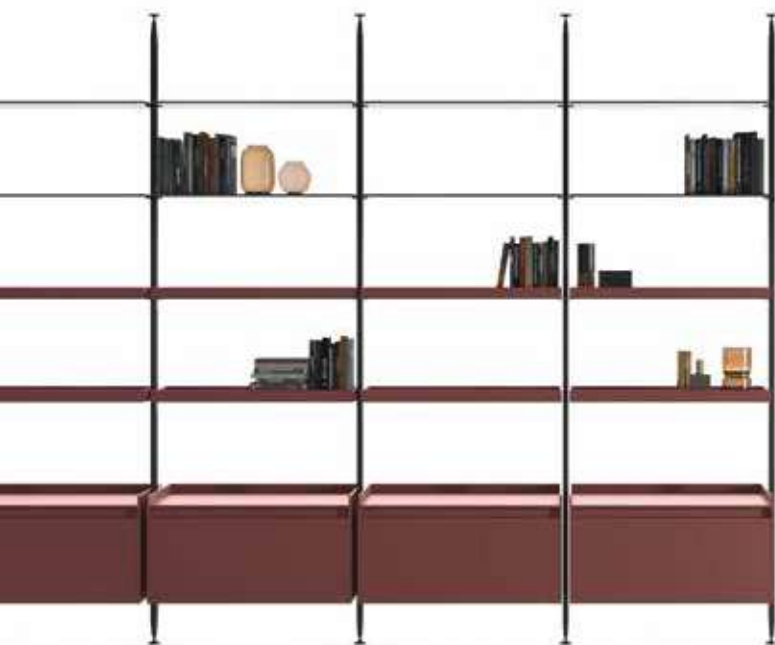

Finiture moduli contenitori:
Storage module finishes:

Melaminico
Fenix Ntm®, Fenix Nta®
Laccati: Soft-Touch, Ossidato, Metal, Lucidi/Sand
Laminato Hpl
Legni: Rovere spazzolato, Noce Canaletto,
Eucalipto sabbaiato, Abete tinto, Noce sabbaiato,
Olmo sabbaiato, Ebano, Olivo
Vetro fumè (ripiani)

Melamine
Fenix Ntm®, Fenix Nta®
Laquered: Soft-Touch, Oxidized, Metal, Glossy/Sand
Laminate Hpl
Woods: Rovere spazzolato, Noce Canaletto,
Eucalipto sabbaiato, Abete tinto, Noce sabbaiato,
Olmo sabbaiato, Ebano, Olivo
Fumè glass (shelves)

Struttura: Alluminio brunito o Bianco
Structure: Brunito Aluminum or White



L-W 77 - 92 - 107 cm
H-H max 300 cm
P-D 30 - 53,9 cm

FEELINGHome

La libreria Vertical si pone come elemento di congiunzione tra gli spazi operativi (cucina) e quelli della convivialità (living).

Si compone di un sistema a palo e si articola con ripiani, vassoi contenitivi e basi sospese. Diverse le finiture disponibili tra cui il vetro Fumè Bronzo per i ripiani, i legni, i laccati e le superfici melaminiche.

I pali di sostegno in alluminio estruso possono essere ancorati dal pavimento al soffitto oppure dal pavimento alla parete.

The Vertical bookcase acts as a link between the functional spaces (kitchen) and the ones for socialising (living room).

It consists of a system of uprights, arranged with shelves, storage trays and base units. Different finishes are available including Fumè Bronzo glass for the shelves, wood, lacquer and melamine surfaces.

The extruded aluminium uprights can be secured from the floor to the ceiling or from the floor to the wall.

La bibliothèque Vertical se positionne comme élément de conjonction entre les espaces opérationnels (cuisine) et les espaces de la convivialité (living).

Elle se compose d'un système à barres et s'articule avec des tablettes, des plateaux de rangement et des meubles bas suspendus. Différentes finitions sont disponibles, parmi lesquelles le verre Fumè Bronzo pour les tablettes, les bois, les laques et les surfaces mélaminées.

Les barres de soutien en aluminium extrudé peuvent être fixées du sol au plafond ou bien du sol au mur.

La librería Vertical se presenta como elemento de conjunción entre los espacios operativos (cocina) y los de la convivencia (living).

Consta de un sistema de postes y se articula con estantes, bandejas de almacenamiento y bases suspendidas.

Diversos los acabados disponibles entre los cuales el vidrio Fumè Bronzo para los estantes, las maderas, los lacados y las superficies melamínicas.

Los postes de soporte de aluminio extruido pueden anclarse del suelo al techo o del suelo ala pared.

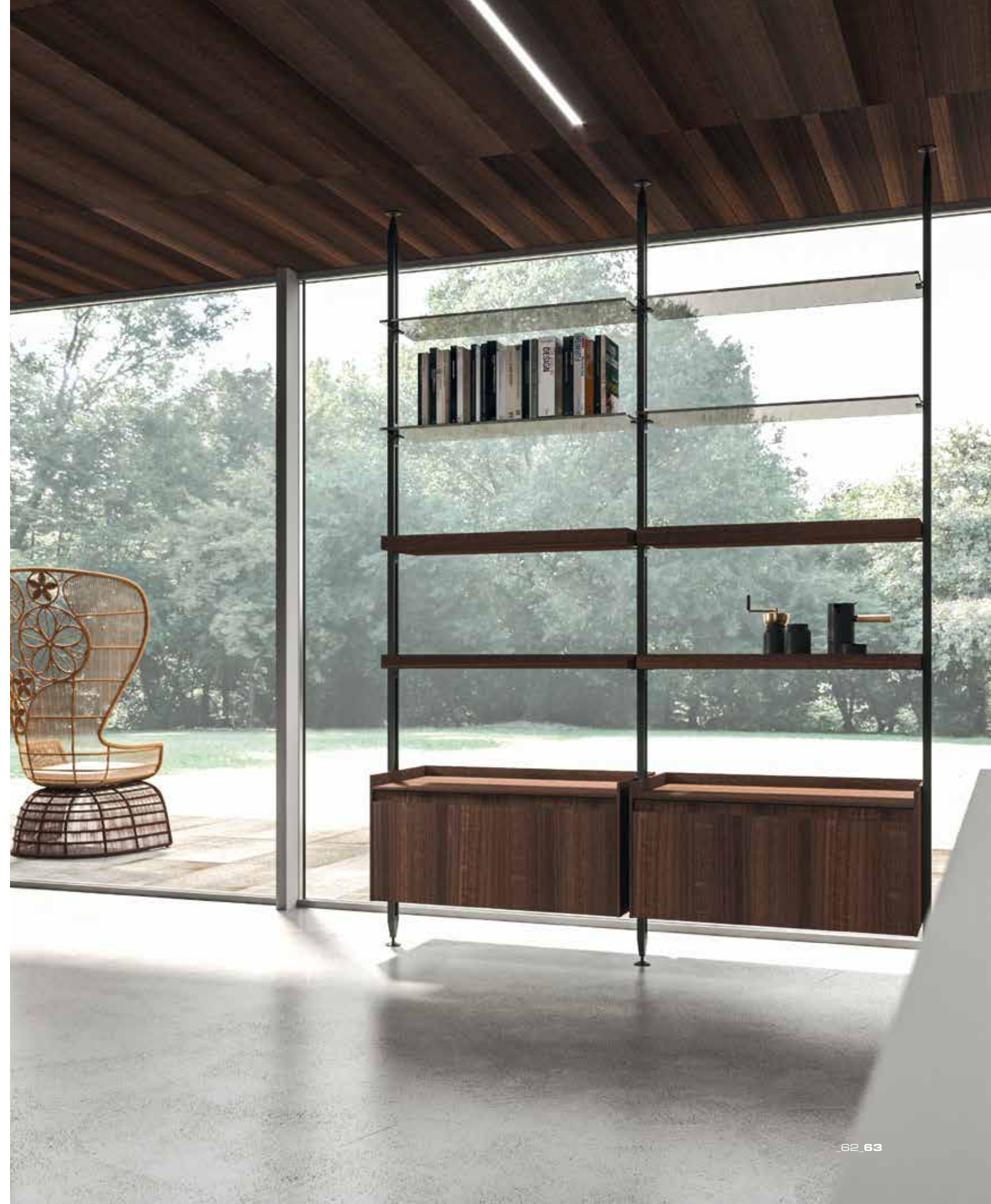



Vertical si distingue per la pulizia del design e le linee stilistiche essenziali e ricercate. Attrezzata con la mensola "T" diventa un mobile di maggiore contenimento. Ripetibile all'infinito grazie all'apparente semplicità costruttiva, arreda ogni spazio.

The stand-out feature of Vertical is its clear-cut design and understated, sophisticated stylistic lines. It becomes a spacious storage unit when fitted with T-shaped shelves. It can be endlessly repeated thanks to its deceptively simple construction and is perfect for furnishing any space.

Vertical se distingue par le caractère épuré du design et ses lignes essentielles et recherchées. Équipée de l'étagère "T", elle devient un meuble avec plus de rangement. Reproductible à l'infini grâce à sa simplicité apparente de construction, elle aménage tous les espaces.

Vertical se distingue por la limpieza del diseño y las líneas estilísticas esenciales y refinadas. Equipada con la estantería "T" se convierte en un mueble con mayor espacio de almacenamiento. Infinitamente repetible gracias a la aparente sencillez de su construcción, amuebla cualquier espacio.





Variante caratterizzata dalla struttura in alluminio finitura bianca, i ripiani in vetro Fumè Bronzo, le mensole contenitive a vassoio e le basi sospese in finitura laccato Bianco Sand. Perfettamente coordinata ed integrata nell'anta la maniglia Step in finitura bianca.

Version featuring the aluminium structure in a white finish, Fumè Bronzo glass shelves, tray-shaped storage shelves and raised base units in Bianco Sand lacquered finish. The white Step handle is perfectly coordinated and integrated into the door.

Variante caractérisée par la structure en aluminium finition blanche, les tablettes en verre Fumè Bronzo, les étagères de rangement à plateau et les meubles bas suspendus en finition laqué Bianco Sand. La poignée Step finition blanche est parfaitement coordonnée et intégrée dans la porte.

Variante caracterizada por la estructura en aluminio acabado blanco, los estantes en vidrio Fumè Bronzo, los estantes de almacenamiento con bandejas y las bases suspendidas en acabado lacado Bianco Sand. Perfectamente coordinado e integrado en la puerta el tirador Step en acabado blanco.





Dotata di mensole vassoio portabottiglie, il sistema Vertical diventa un raffinato elemento d'arredo che può delimitare un nuovo spazio degustazione in ambito domestico.

Fitted with bottle racks, the Vertical system becomes a refined item of furnishing that can define a new area in your home in which to enjoy a glass of wine.

Dotée d'étagères à plateaux porte-bouteilles, le système Vertical devient un élément d'ameublement raffiné qui peut délimiter un nouvel espace dégustation dans un contexte domestique.

Dotada de repisas bandeja portabotellas, el sistema Vertical se convierte en un refinado elemento de decoración que puede delimitar un nuevo espacio de degustación en ámbito doméstico.



Finiture Finishes:

Melaminico
 Laccati: Soft-Touch, Ossidato, Metal, Lucidi/Sand
 Laminato Hpl
 Fenix Ntm®, Fenix Nta®
 Legni: Rovere pazzolato, Rovere fiammato,
 Castagno spazzolato, Rovere antico, Abete tinto,
 Olmo sabbaiato, Eucalipto, Noce Canaletto,
 Noce fumo, Castagno fumè, Ebano, Olivo

Melamine
 Laquered: Soft-Touch, Oxidized, Metal, Glossy/Sand
 Laminated Hpl
 Fenix Ntm®, Fenix Nta®
 Woods: Rovere pazzolato, Rovere fiammato,
 Castagno spazzolato, Rovere antico, Abete tinto,
 Olmo sabbaiato, Eucalipto, Noce Canaletto,
 Noce fumo, Castagno fumè, Ebano, Olivo

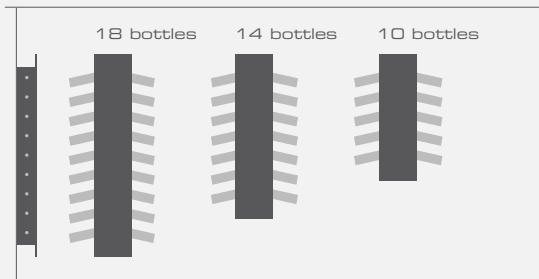

L-W 30 cm
 H-H 100 - 130 - 160 cm
 P-D 15 cm

Complemento di assoluta funzionalità, Ak_Winery entra tra gli accessori cucina. Il pensile portabottiglie personalizzabile in molteplici finiture garantisce l'ottimale conservazione del vino grazie alla specifica inclinazione delle bottiglie e nel contempo diventa forte elemento d'arredo.

Ak_Winery, a highly functional furnishing addition, takes its place among the kitchen accessories. The bottle rack, with a choice of multiple custom finishes, ensures the wine is correctly stored, thanks to the special angle at which the bottles are placed, while adding a distinctive element of style to the decor.

Complément d'une fonctionnalité absolue, Ak_Winery entre à faire partie des accessoires de la cuisine. Le meuble haut porte-bouteilles personnalisable en de multiples finitions garantit la conservation optimale du vin grâce à l'inclinaison spécifique des bouteilles et devient en même temps un élément d'ameublement important.

Complemento de absoluta funcionalidad, Ak_Winery se une a los accesorios de la cocina. El colgante portabotellas personalizable en múltiples acabados garantiza la óptima conservación del vino gracias a la específica inclinación de las botellas y al mismo tiempo se convierte en un fuerte elemento de decoración.



Boiserie Strato



Finiture Finishes:

Melaminico Termostrutturato e Supermatt
Tecnolux
Tecnomatt
Fenix Ntm®, Fenix Nta®
Laminato Hpl
Laccati: Soft-Touch, Ossidato, Metal, Lucidi/Sand
Legni: vedi listino

Melamine Thermoframed end Supermatt
Tecnolux
Tecnomatt
Fenix Ntm®, Fenix Nta®
Laminate Hpl
Laquered: Soft-Touch, Oxidized, Metal, Glossy/Sand
Woods: consult price list

20 4



L-W max 300 cm
H-H max 300 cm
P-D pannelli panels 4+20 cm - mensole shelves sp.1 cm

FEELINGHome

La boiserie Strato arreda con eleganza. La combinazione tra finiture e modularità consente di creare pareti attrezzate di qualsiasi dimensione, in grado di offrire soluzioni uniche e dal design lineare grazie al sistema di fissaggio a scomparsa e all'utilizzo di mensole in spessore 1 cm.

The boiserie Strato furnishes with elegance. The combination of finishes and modular layout create accessorised walls of different sizes, providing unique, linear design solutions thanks to a concealed attachment system and the use of 1cm deep shelves.

La boiserie Strato aménage avec élégance. La combinaison entre finitions et modularité permet de créer des parois équipées de n'importe quelle taille, capables d'offrir des solutions uniques et au design linéaire grâce au système de fixation invisible et à l'utilisation d'étagères d'1 cm d'épaisseur.

La boiserie Strato amuebla con elegancia. La combinación de acabados y la modularidad permiten crear paredes equipadas de cualquier tamaño, capaces de ofrecer soluciones únicas con un diseño lineal gracias al sistema de fijación oculta y al uso de estantes de 1 cm de grosor.





Planar/Free



FREE

Finiture Finishes:

Melaminico Termostrutturato e Supermatt
 Tecnolux
 Tecnomatt
 Fenix Ntm®, Fenix Nta®
 Laminato Hpl
 Laccati: Soft-Touch, Ossidato, Metal, Lucidi/Sand
 Legni: vedi listino

Melamine Thermoframedd end Supermatt
 Tecnolux
 Tecnomatt
 Fenix Ntm®, Fenix Nta®
 Laminato Hpl
 Laquered: Soft-Touch, Oxidized, Metal, Glossy/Sand
 Woods: consult price list

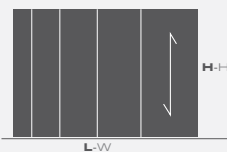

L-W moduli da modul from 30 a to 90 cm
 H-H max 400 cm - vedi listino consult price list
 P-D 1,8 + 0,5 cm

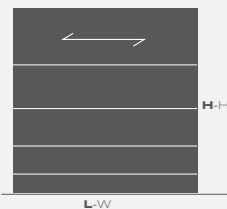

L-W max 400 cm - vedi listino consult price list
 H-H moduli da modul from 30 a to 90 cm
 P-D 1,8 + 0,5 cm

FEELINGHome

I pannelli Planar e Free diventano superfici d'arredo. Attraverso l'utilizzo di moduli di dimensioni variabili (da 30 a 90 cm) fissati a parete con un sistema a scomparsa, rivestono ampie superfici murali che diventano sfondo per i complementi d'arredo.

I pannelli possono essere montati in senso verticale o orizzontale. La versione Planar si caratterizza per l'inserimento del profilo di alluminio brunito che crea una fuga di 4 mm tra pannello e pannello. La versione Free prevede l'accostamento diretto dei pannelli.

The Planar and Free panels become décor surfaces. Through the use of modules of varying sizes (from 30 to 90 cm) with a concealed attachment system, they cover large areas of wall, providing a backdrop for furnishing accessories.

The panels can be mounted either vertically or horizontally. The Planar version features a signature burnished aluminium profile which creates a 4 mm gap between the panels. In the Free version, the panels are fitted together directly.

Les panneaux Planar et Free deviennent des surfaces d'ameublement. À travers l'utilisation de modules aux dimensions variables (de 30 à 90 cm), fixés au mur avec un système invisible, ils habillent de grandes surfaces murales qui deviennent un fond pour les compléments d'ameublement. Les panneaux peuvent être montés à la verticale ou à l'horizontale. La version Planar se caractérise par l'insertion du profilé en aluminium bruni qui crée un joint de 4 mm entre deux panneaux. La version Free prévoit la juxtaposition directe des panneaux.

Los paneles Planar y Free se convierten en superficies de decoración. Mediante el uso de módulos de tamaños variables (de 30 a 90 cm) fijados en la pared con un sistema abatible, cubren grandes superficies de paredes que se convierten en un fondo para los complementos de decoración. Los paneles pueden montarse en sentido vertical u horizontal. La versión Planar se caracteriza por la introducción del perfil de aluminio bruñido que crea una escape de 4 mm entre panel y panel. La versión Free prevé el acercamiento directo de los paneles.

PLANAR

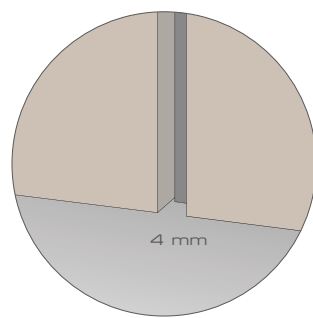
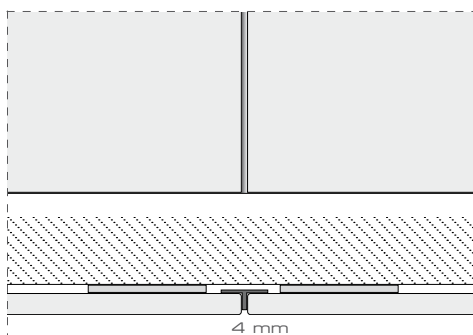

FREE

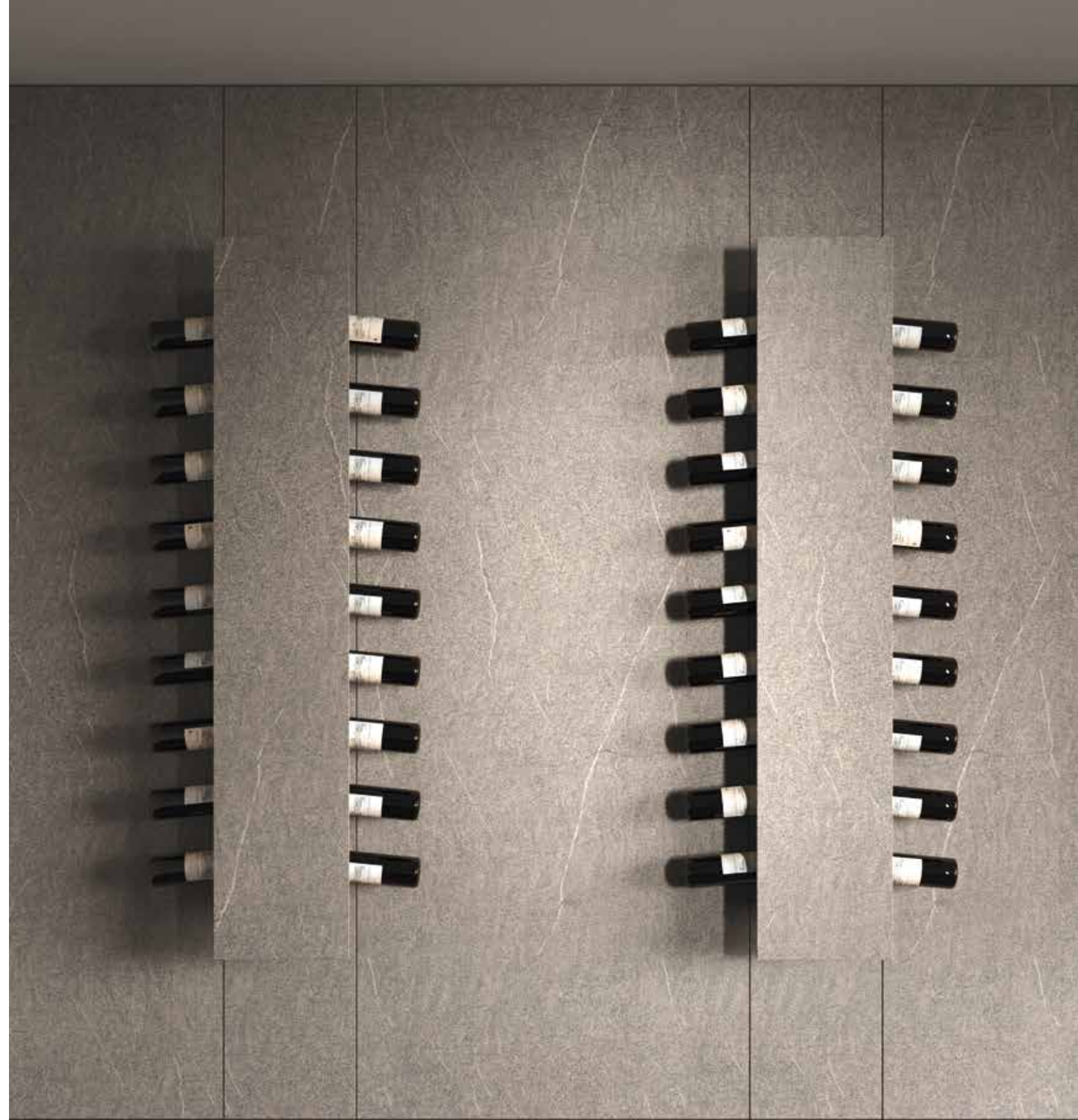
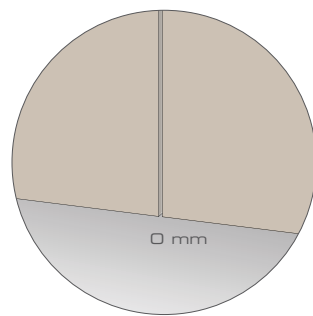
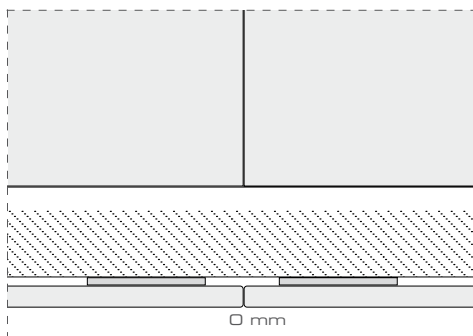

PLANAR

AkB_Case



Finiture Finishes:

Ardesia
Bianco
Vetro fumè
Finitura schiena vedi listino (solo versioni a parete)

Ardesia
Bianco
Fumè glass
Back panel finish, see price list (wall version only)



L-W 90 - 120 - 150 cm
H-H 28 cm
P-D 20 cm



L-W 90 - 120 - 150 cm
H-H 52 cm
P-D 20 cm

AkB_Case è un elemento contenitivo che si sviluppa su due livelli assolvendo anche ad una funzione di divisorio. Può essere collocato sul piano di lavoro, sul tavolo o sull'isola, secondo le esigenze di spazio e le necessità operative. Possibile anche l'inserimento come pensile sulla boiserie Strato, abbinato alle sottili mensole da 1 cm, oppure anche a parete.

AkB_Case is a storage unit which is laid out on two levels and also acts as a partition. It can be placed on the work top, table or island depending on your work and space requirements. It can also be inserted as a wall unit on the boiserie Strato, combined with the 1 cm slimline shelves or also on the wall.

AkB_Case est un élément de rangement qui se développe sur deux niveaux et qui sert également de séparateur. Il peut être placé sur le plan de travail, sur la table ou sur l'îlot, en fonction des exigences d'espace et des besoins fonctionnels. Il est également possible de l'utiliser comme meuble haut sur la boiserie Strato, associé aux étagères fines d'1 cm, ou même au mur.

AkB_Case es un elemento de contención que se desarrolla en dos niveles, sirviendo también de tabique. Se puede colocar en la encimera, en la mesa o en la isla, en función de las exigencias de espacio y de las necesidades operativas. También es posible la inserción como colgante en la boiserie Strato, combinado con finas repisas de 1 cm, o también en la pared.







La scocca viene realizzata in due colori Ardesia e Bianco mentre l'eventuale schiena può essere della stessa finitura degli elementi presenti nella composizione cucina.
AkB_Case viene completato con i vetri fumè scorrevoli che chiudono parzialmente il contenitore.

The main structure comes in two colours, Ardesia and Bianco, while the optional back panel can be in the same finish as the elements featured in the kitchen composition.
AkB_Case is completed with sliding fumè glass doors which partially enclose the storage space.

La structure est réalisée en deux coloris Ardesia et Bianco alors que l'éventuel fond peut être réalisé dans la même finition que les éléments présents dans la composition de la cuisine.
AkB_Case est complété par les vitres fumè coulissantes qui ferment partiellement le compartiment.

La estructura está realizada en dos colores Ardesia y Bianco mientras que el eventual espaldar puede ser del mismo acabado de los elementos presentes en la composición cocina.
AkB_Case se completa con los vidrios fumè deslizantes que cierran parcialmente el contenedor.





Finiture Finishes:

Scocca: Alluminio Satinato e Brunito
Carcass: Alluminio Satinato e Brunito

Ripiani e schienali:
Melaminico
Tecnolux
Tecnomatt
Fenix Ntm®, Fenix Nta®
Laminato Hpl
Laccati: Soft-Touch, Ossidato, Metal, Sand
Legni: vedi listino

Shelf and backpanels:
Melamine
Tecnolux
Tecnomatt
Fenix Ntm®, Fenix Nta®
Laminate Hpl
Laquered: Soft-Touch, Oxidized, Metal, Sand
Woods: consult price list

Configurazioni: vedi listino
Configurations: consult price list

Day Box



L-W 60 - 75 - 90 cm
H-H 55 cm
P-D 15 cm

Day Box Open



L-W 60 - 75 - 90 cm
H-H 55 ± 70,8 cm
P-D 15 cm

Gli elementi modulari DayBox estendono la capacità contenitiva diventando anche oggetti d'arredo.
Diverse attrezzature disponibili con ripiani, porta calici o dotati di contenitori in vetro, rendono lo spazio cucina ancor più funzionale.
Il DayBox Open viene realizzato a misura variabile (senza fondo e coperchio) per essere posizionato direttamente sul piano di lavoro.

The DayBox modular elements expand the storage capacity and also become a furnishing item.
The different fittings available with shelves, glass holders or glass storage containers make the kitchen space even more functional.
DayBox Open comes in various sizes (without the bottom and lid) so it can be placed directly on the worktop.

Les éléments modulables DayBox étendent la capacité de rangement et deviennent eux-aussi des objets d'ameublement.
Plusieurs équipements disponibles avec des tablettes, des porte-verres ou dotés de récipients en verre, rendent l'espace cuisine encore plus fonctionnel.
Le DayBox Open est réalisé avec une taille variable (sans fond et sans panneau supérieur) pour être directement positionné sur le plan de travail.

Los elementos modulares DayBox extienden la capacidad de almacenamiento convirtiéndose también en objetos de decoración.
Diversos equipos disponibles con estantes, porta cáliz o dotados de contenedores en vidrio, hacen el espacio de la cocina todavía más funcional.
El DayBox Open está realizado con medida variable (sin fondo y tapa) para ser colocado directamente en la encimera.

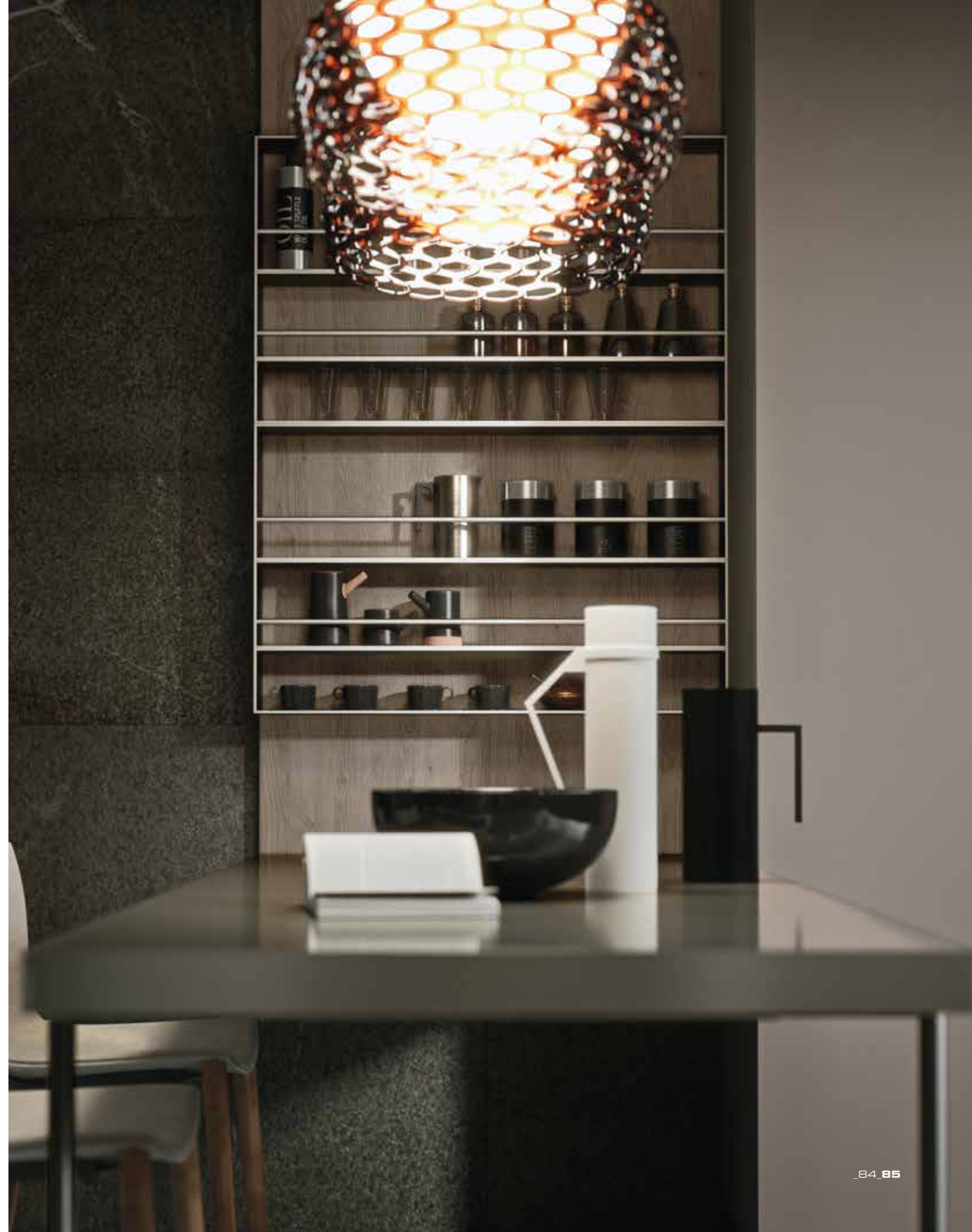



Shangai



Finiture Finishes:

Laccato Sand
Legni: vedi listino

Laquered Sand
Woods: consult price list



L-W 60 cm
H-H 60 cm
P-D 27,2 cm



L-W 90 cm
H-H 60 cm
P-D 27,2 cm



L-W 120 cm
H-H 60 cm
P-D 27,2 cm

Gli elementi a giorno Shangai assicurano una personalizzazione estrema degli spazi. La struttura composta da pannelli incastrati tra loro crea un gioco di linee che danno origine ad un interessante intreccio estetico. Ogni singolo elemento è dotato d'illuminazione LED perimetrale.

The Shangai open elements give you the freedom to customise spaces. The structure, consisting of interlocked panels, creates a play on the lines which, in turn, produce an eye-catching intertwined look. Each individual element has LED lighting on the outer edge.

Les éléments ouverts Shangai assurent une personnalisation extrême des espaces. La structure composée de panneaux encastrés les uns dans les autres crée un jeu de lignes qui produit un entrelacement esthétique captivant. Chaque élément est doté d'un éclairage LED périmétrique.

Los elementos abiertos Shangai garantizan una personalización extrema de los espacios. La estructura compuesta por paneles entrelazados crea un juego de líneas que da lugar a un interesante entramado estético. Cada elemento individual está dotado de iluminación LED perimetral.





Mensola "T"



Finiture Finishes:

Melaminico Termostrutturato e Supermatt
Fenix Ntm®
Laminato HPL
Laccati: Lucidi/Sand, Soft-Touch, Ossidato e Metal
Legni: vedi listino

Melamine Thermoframed and Supermatt
Fenix Ntm®
Laminato HPL
Laquered: Glossy/Sand, Soft-Touch, Oxidized, Metal
Woods: consult price list

Elemento semplice e trasversale, la mensola "T" è particolarmente robusta grazie alla sua schiena verticale, ed è disponibile in diverse finiture.

A simple and useful element, the T-shaped shelf is extra strong thanks to the vertical back panel. It is available in a variety of finishes.

Élément simple et transversal, l'étagère "T" est particulièrement robuste grâce à son fond vertical, et est disponible avec différentes finitions.

Elemento simple y transversal, el estante "T" es particularmente robusto gracias a su espaldar vertical, y está disponible en diferentes acabados.



L-W 45 - 60 - 90 - 120 cm
H-H 22 cm
P-D 20+1 cm



Mirror System



Finiture Finishes:

Melaminico
Fenix Ntm®
Laminato HPL
Laccati: Lucidi/Sand, Soft-Touch, Ossidato e Metal
Legni: Rovere spazzolato, Olmo sabbato,
Noce sabbato fumo, Noce Canaletto, Eucalipto
sabbato, Ebano opaco, Olivo opaco

Melaminet
Fenix Ntm®
Laminat HPL
Laquered: Glossy/Sand, Soft-Touch, Oxidized, Metal
Woods: Rovere spazzolato, Olmo sabbato,
Noce sabbato fumo, Noce Canaletto, Eucalipto
sabbato, Ebano opaco, Olivo opaco



L-W 90
H-H 96 cm
P-D 10 cm



L-W 150
H-H 60 cm
P-D 10 cm



L-W 120
H-H 120 cm
P-D 10 cm



L-W 120
H-H 210 cm
P-D 10 cm

LED perimetrale specchio opzionale
Optional mirror perimeter LED

Mirror System è la nuova collezione di specchi. Proposti in varie dimensioni soddisfano ogni esigenza funzionale/estetica. Possono essere realizzati con cornice in melaminico, laccato, legno o Fenix Ntm®.

Mirror System is the new collection of mirrors. They come in different sizes to satisfy all functional/aesthetic requirements. They can be produced with a melamine-faced lacquered wood or Fenix Ntm® frame.

Mirror System est la nouvelle collection de miroirs. Proposés en plusieurs dimensions, ils répondent à chaque exigence fonctionnelle/esthétique. Ils peuvent être réalisés avec un cadre en mélaminé, laqué, bois ou Fenix Ntm®.

Mirror System es la nueva colección de espejos. Propuestos en diversos tamaños satisfacen cualquier exigencia funcional/estética. Pueden estar realizados con marco en melamínico, lacado, maderas o Fenix Ntm®.





Un elegante profilo LED integrato sul perimetro interno dello specchio sottolinea ancor più il design e la pulizia dell'oggetto.

An elegant, integrated LED profile on the inner edge of the mirror further highlights the design and clean lines of the mirror.

Un profilé LED élégant intégré sur le contour intérieur du miroir souligne encore plus son design et l'aspect épuré de l'objet.

Un elegante perfil LED integrado en el perímetro interno del espejo resalta aún más la limpieza del objeto.



Pass System



Finiture Finishes:

Melaminico Termostrutturato e Supermatt
Fenix Ntm®
Laminato HPL
Laccati: Lucidi/Sand, Soft-Touch, Ossidato
Legni: Rovere spazzolato, Olmo sabbato,
Noce sabbato fumo, Noce Canaletto, Eucalipto
sabbato, Ebano opaco, Olivo opaco

Melamine Thermoframed and Supermatt
Fenix Ntm®
Laminato HPL
Laquered: Glossy/Sand, Soft-Touch, Oxidized
Woods: Rovere spazzolato, Olmo sabbato,
Noce sabbato fumo, Noce Canaletto, Eucalipto
sabbato, Ebano opaco, Olivo opaco



Maniglia Handle 097



Maniglia Handle 096

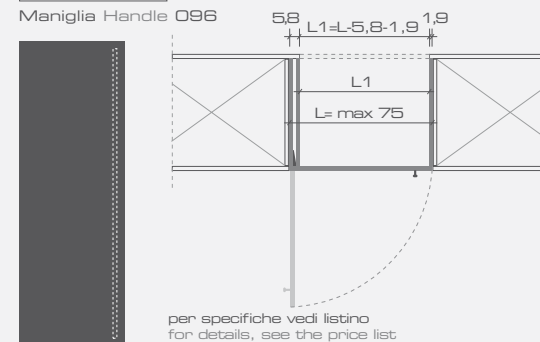

L-W 75 cm
H-H 212 - 219 - 236 - 260 cm
P-D 2,2 cm

La porta Pass System è uno degli elementi funzionali presenti nella collezione Feeling Home. Il nuovo modulo può essere collocato tra le colonne d'arredo, oppure tra una boiserie a parete creando un passaggio. I pannelli-porta sono dotati a richiesta di eleganti maniglie, sporgenti o ad incasso, che garantiscono la presa.

The Pass System door is one of the functional elements in the Feeling Home collection. The new module can be placed between decorative tall units or between a wall-mounted boiserie to create a passageway. On request, the panels can be fitted with elegant external or recessed handles guaranteeing a sure grip.

La porte Pass System est l'un des éléments fonctionnels présents dans la collection Feeling Home. Le nouveau module peut être placé entre les colonnes d'ameublement, ou encore entre une boiserie murale pour créer un passage. Les panneaux de porte sont dotés sur demande de poignées élégantes, saillantes ou encastrables, qui garantissent la prise.

La puerta Pass System es uno de los elementos funcionales presentes en la colección Feeling Home. El nuevo módulo puede colocarse entre las columnas de decoración, o entre una boiserie de pared creando un paso. Los paneles de la puerta están dotados bajo pedido de elegantes tiradores, salientes o empotrados, que garantizan el agarre.

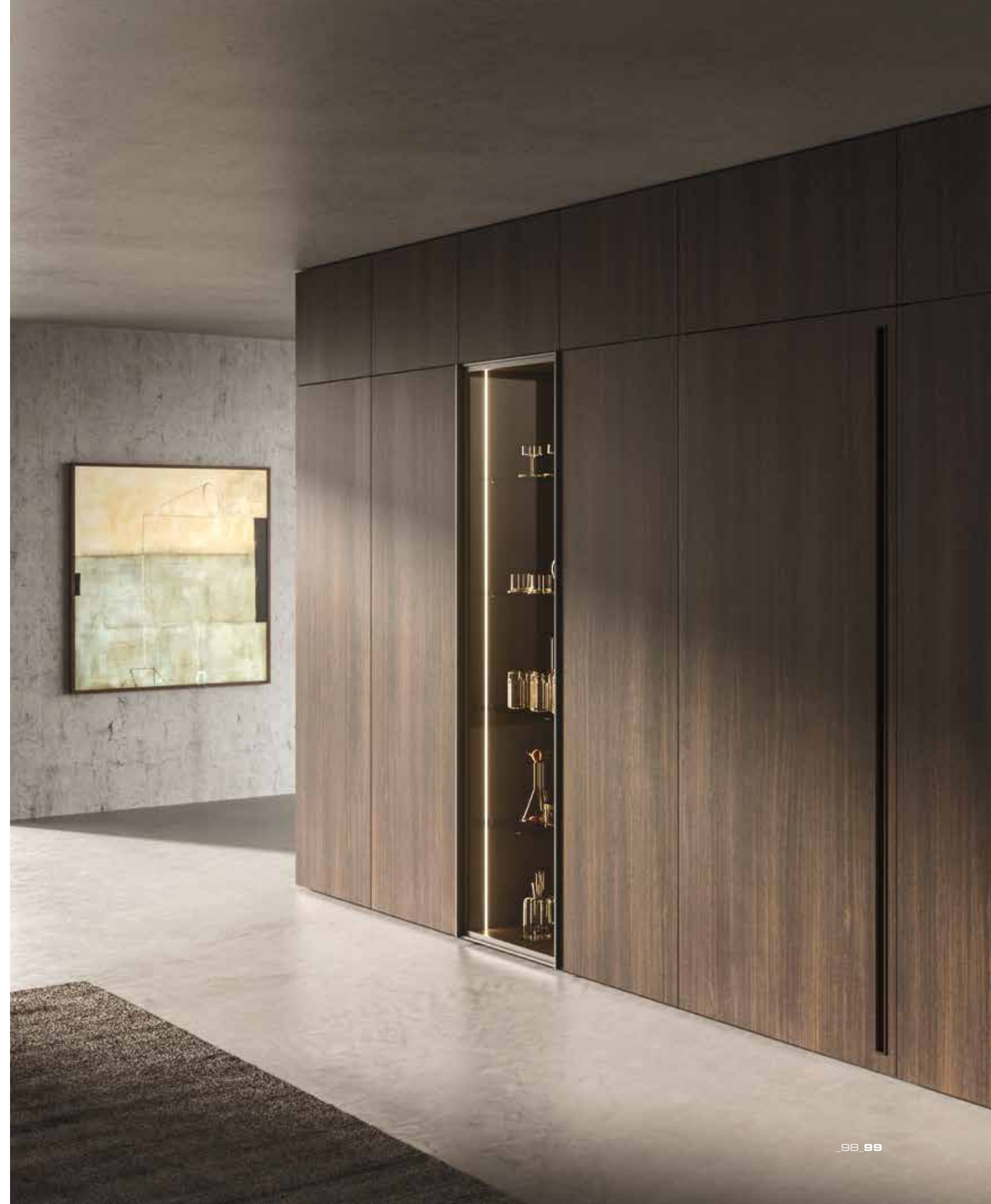



Plank



Finiture Finishes:

Melaminico
Fenix Ntm®, Fenix Nta®
Laminato HPL
Laccati: Lucidi/Sand, Soft-Touch, Ossidato e Metal
Legni: vedi listino

Melamine
Fenix Ntm®, Fenix Nta®
Laminato HPL
Laquered: Glossy/Sand, Soft-Touch, Oxidized, Metal
Woods: consult price list

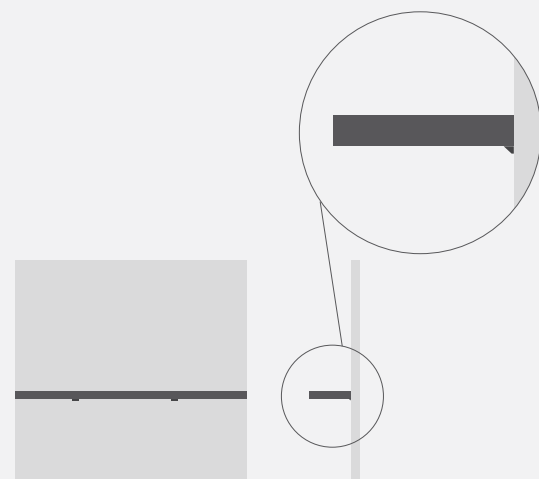

L-W 280 cm max
H-H 6 cm
P-D min. 42 max 52 cm

FEELINGHome

Per creare angoli multifunzionali nasce Plank, piano d'appoggio (spessore 6 cm) a sbalzo con staffe a semi-incasso nel sottopiano. Spiccatamente lineare e agile, trova spazio in tantissime situazioni e consente di utilizzare spazi di risulta o dedicati trasformandoli in funzionali soluzioni home/office.

Plank, the cantilever top (6 cm thick) with semi-recessed support brackets underneath, stems from the need to create multi-purpose areas. With its distinctive linear and slender design, it can be used in a variety of situations in unused or dedicated spaces, transforming them into functional home/office solutions.

Plank, plan d'appui (épaisseur 6 cm) en porte-à-faux avec supports semi-encastrables dans l'espace sous-plan, est né pour créer des coins multifonctions. Linéaire et flexible, il trouve sa place dans de très nombreuses situations et permet d'utiliser des espaces vides ou dédiés en les transformant en des solutions home/office fonctionnelles.

Para crear rincones multifuncionales nace Plank, encimera de apoyo (espesor 6 cm) voladiza con soportes semiempotrados en el nivel inferior. Claramente lineal y ágil, puede utilizarse en muchas situaciones y permite el uso de espacios existentes o dedicados, transformándolos en soluciones funcionales home/office.



Basket



L-W 45 cm
H-H 25 cm
P-D 45 cm



Tessuto MONTECARLO Antracite ML62 |
MONTECARLO Antracite fabric ML62

FEELINGHome

Il cestone rivisitato trova spazio tra i nuovi complementi d'arredo. Pratico e contenitivo, diventa esso stesso oggetto d'uso quotidiano. Simile ad un cassetto ma più giocoso e innovativo grazie anche ai performanti tessuti ad alta resistenza, atossici, anallergici e resistenti alle muffe, che ne consentono la realizzazione.

The revamped basket is a new entry in the range of furnishing accessories. Practical with lots of storage space, it becomes an object for daily use. Reminiscent of a chest of drawers, but with a more playful and innovative approach, thanks also to the high-performance, non-toxic, hypoallergenic and mould-resistant fabrics from which it is made.

Le panier revisité trouve sa place parmi les nouveaux compléments d'ameublement. Grand et pratique, il devient un objet d'usage quotidien. Similaire à un tiroir mais plus malin et innovant aussi grâce aux tissus performants à haute résistance, atoxiques, anallergiques et résistants aux moisissures, qui en permettent la réalisation.

La cesta rediseñada encuentra espacio entre los nuevos complementos de decoración. Práctica y contenedora, se convierte en un objeto de uso diario. Similar a un cajón pero más lúdica e innovadora también gracias a los tejidos de alto rendimiento y alta resistencia, atóxicos, hipoalergénicos y resistentes al moho, que permiten su realización.



Gem



Finiture Finishes:

Finitura Scocca:
Melaminico
Fenix Ntm®, Fenix Nta®
Laccati: Soft-Touch, Ossidato, Metal, Lucidi/Sand
Legni: vedi listino

Carcass finishes:
Melamine
Fenix Ntm®, Fenix Nta®
Laquered: Soft-Touch, Oxidized, Metal, Glossy/Sand
Woods: consulti price list

Telaio: alluminio Brunito o verniciato Ardesia
Frame: aluminium Brunito or Ardesia

Vetro: Fumè Bronzo o trasparente
Glass: Bronzo Fumè or clear glass

Pensili Wall units

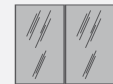

L-W 45 - 60 - 90 cm
H-H 48 - 60 - 79 - 96 cm
P-D 34,2 cm

Colonne Tall units

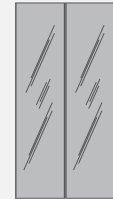

L-W 45 - 60 - 90 cm
H-H 139 - 199 - 211 - 218 - 235 cm
P-D 34,2 - 57 - 67 cm

FEELINGHome

Le vetrine Gem sono una soluzione particolare ed elegante sia per l'ambiente cucina che per la zona giorno.

La scocca è personalizzabile nelle numerose finiture presenti a listino. Discreta ed elegante l'illuminazione sia ad incasso che posizionata dietro ai ripiani in vetro.

The Gem display cases are a unique and elegant solution for both the kitchen and daytime area. The body can be customised in the numerous finishes featured in the price list. The lighting is both discrete and elegant, whether recessed or fitted behind the glass shelves.

Les vitrines Gem sont une solution particulière et élégante pour l'espace cuisine comme pour l'espace séjour.

La structure est personnalisable dans les nombreuses finitions présentes dans les tarifs. Discret et élégant l'éclairage encastrable ou positionné derrière les tablettes en verre.

Las vitrinas Gem son una solución particular y elegante tanto para el ambiente de la cocina como para la zona día. La estructura se puede personalizar en los numerosos acabados presentes en la lista. Discreta y elegante la iluminación tanto empotrada como colocada detrás de los estantes en vidrio.



_106_107



Le colonne, oltre ai classici ripiani in vetro Fumè Bronzo, possono essere attrezzate con nuovi accessori dall'effetto sospeso, che le rendono più funzionali e affascinanti.

In addition to the classic Fumè Bronzo glass shelves, the tall units can be fitted with new accessories with a suspended effect, which give them added visual appeal and functionality.

Les colonnes peuvent être équipées de tablettes classiques en verre Fumè Bronzo, mais aussi de nouveaux accessoires à l'effet suspendu, qui les rendent plus fonctionnelles et captivantes.

Las columnas, además de los clásicos estantes en vidrio Fumè Bronzo, pueden equiparse con nuevos accesorios con efecto de suspensión, que las hacen más funcionales y fascinantes.





Esprimono massima versatilità fissate a parete ed abbinate alla boiserie o appese singolarmente. Riescono sempre ad esprimere tutta l'eleganza e il carattere che le contraddistinguono.

They showcase their excellent versatility when either fixed to the wall and combined with the boiserie or when hung individually. They always succeed in showcasing all their elegance and stand-out features.

Elles expriment le maximum de polyvalence fixées au mur et associées à la boiserie ou suspendues individuellement. Elles arrivent toujours à exprimer toute l'élégance et le caractère qui les caractérisent.

Expresan máxima versatilidad fijadas en la pared y combinadas con la boiserie o colgadas individualmente. Logran siempre expresar toda la elegancia y el carácter que las distinguen.



Finiture Finishes:

Melaminico
 Fenix Ntm® e Fenix Nta®
 Laminato HPL
 Laccati: Lucidi/Sand, Soft-Touch, Ossidato e Metal
 Gres
 Legni: vedi listino

LED 3000° k

Melamine
 Fenix Ntm® e Fenix Nta®
 Laminato HPL
 Laquered: Glossy/Sand, Soft-Touch, Oxidized, Metal
 Gres
 Woods: consult price list

LED 3000° k

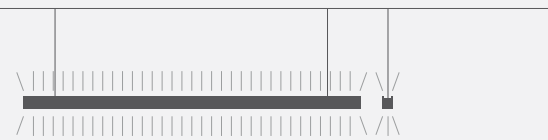

L-W 90 - 120 - 150 - 180 - 210 - 240 - 270* - 300 cm
 H-H 10 cm
 P-D 7,4 cm
 H max cavi H max cable length 180 cm

*Lunghezza massima finiture Melaminico
 *Maximum length melamine-faced finish

Di grande interesse per il design e la soluzione tecnologica la lampada Lympha è un sistema a sospensione alimentato a LED con emissione bidirezionale, che garantisce l'ottima illuminazione del piano di lavoro e contestualmente una puntuale luce diffusa. Disponibile in diverse misure, è personalizzabile con le finiture della collezione.

The Lympha pendant light has a highly attractive design, powered by LEDs with two-way light emission, which guarantees excellent illumination over the worktop combined with a precise diffused light. Available in different sizes, it can be customised with the different finishes featured in the collection.

D'un grand intérêt pour le design et la solution technologique, la lampe Lympha est un système à suspension alimenté à LED à émission bidirectionnelle, qui garantit l'éclairage optimal du plan de travail et en même temps une lumière diffuse précise. Disponible en plusieurs tailles, elle est personnalisable avec les finitions de la collection.

De gran interés para el design y la solución tecnológica la lámpara Lympha es un sistema de suspensión alimentado por LED con emisión bidireccional, que garantiza una excelente iluminación de la encimera y al mismo tiempo una precisa luz difusa. Disponible en diferentes tamaños, se puede personalizar con los acabados de la colección.



_Tables

_Chairs

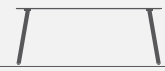

Toah

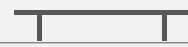

Panka



Nice



Queeny



Slim



Color



Plate



Logic



Linear



Slight



Loft



Tacky



| | |
|--------|----------|
| Toah | _116_119 |
| Nice | _120_123 |
| Slim | _124_127 |
| Plate | _128_131 |
| Linear | _132_135 |

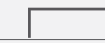

| | |
|------|----------|
| Loft | _136_139 |
|------|----------|



| | |
|--------|----------|
| | _140_141 |
| Panka | |
| Queeny | _142_143 |
| Color | _144_145 |
| Logic | _146_147 |



| | |
|--------|----------|
| Slight | _148_149 |
| Tacky | _150_151 |

Toah



Il tavolo Toah presenta il piano in gres da 5 mm e lastra di vetro trasparente con quattro bordi smussati. Le gambe sono inclinate e hanno la stessa finitura del piano su due facce. La struttura metallica può essere verniciata nera o bianca con piedino regolabile.

The Toah table features a 5 mm stoneware top and sheet of clear glass with four bevelled edges. The legs are slanted and feature the same finish as the top on two sides. The metal structure can be painted in black or white and has adjustable feet.

La table Toah présente un plateau en grès de 5 mm et une plaque en verre transparent avec quatre bords biseautés. Les pieds sont inclinés et ont la même finition que le plateau sur deux faces. La structure métallique peut être peinte en noir ou blanc et dispose d'un pied réglable.

La mesa Toah tiene la encimera en gres de 5 mm y losa de vidrio transparente con cuatro bordes biselados. Las patas están inclinadas y tienen el mismo acabado de la encimera en dos caras. La estructura metálica puede estar pintada en blanco o negro con pie ajustable.



L-W 120 x 120 cm
L-W 140 x 140 cm
H-H 75,5 cm

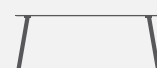

L-W 160 x 90 cm
L-W 180 x 90 cm
L-W 200 x 100 cm
L-W 220 x 100 cm
L-W 240 x 100 cm
H-H 75,5 cm





FINITURE - FINISHES - FINITIONS - ACABADOS

Struttura gambe Legs structure

Metallo verniciato Nero opaco Metal Nero matt varnished
Metallo verniciato Bianco opaco Metal Bianco matt varnished

Supporto vetro Glass support

Cristallo extrachiaro sp. 10 mm Extra clear glass 10 mm th.

Piani e rivestimento gambe Tops table and coating legs

Gres/MDI sp. 5/6 mm (gres Laminam/MDI Inalco) vedi listino Stoneware th. 5-6 mm (Laminam/Inalco MDI) see price list.



Nice

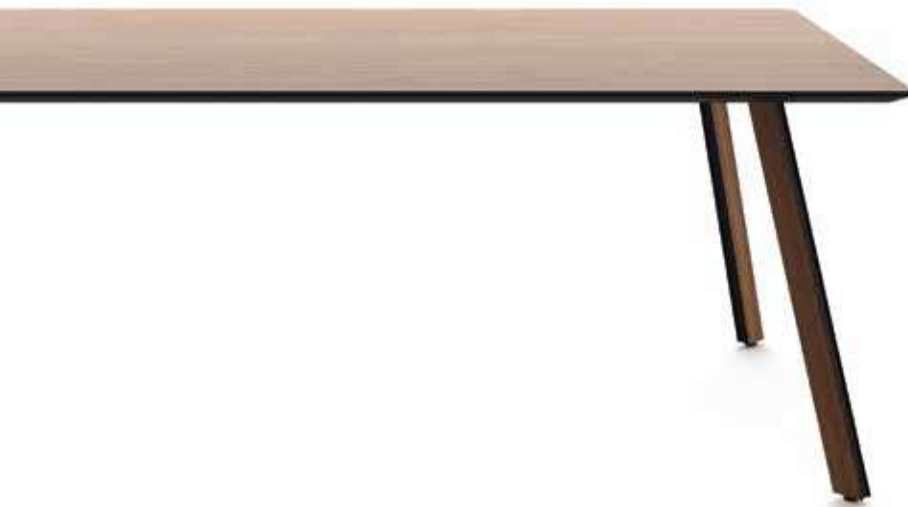

Il tavolo Nice, variante in laminato del tavolo Toah, propone il piano in MDF laccato nero opaco con rivestimento superiore in laminato HPL.
Le gambe inclinate hanno rivestimento su due facce.
La struttura può essere nera o bianca con piedino regolabile.

The Nice table, the laminated version of the Toah table, has a top in matt black lacquered MDF with upper coating in HPL laminate.
The slanted legs are coated on two sides.
The structure can be black or white, with adjustable feet.

La table Nice, variante en stratifié de la table Toah, propose le plateau en MDF laqué noir mat avec un revêtement supérieur en stratifié HPL.
Les pieds inclinés ont un revêtement sur deux faces.
La structure peut être noire ou blanche avec un pied réglable.

La mesa Nice, variante en laminado de la mesa Toah, propone la encimera en MDF lacado negro opaco con revestimiento superior en laminado HPL.
Las patas inclinadas tienen revestimiento en dos caras.
La estructura puede ser negra o blanca con pie ajustable.

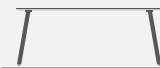

L-W 140 x 80 cm
L-W 160 x 90 cm
L-W 180 x 90 cm
L-W 210 x 100 cm
H-H 75 cm





FINITURE - FINISHES - FINITIONS - ACABADOS

Piano e gambe Top and laegs table

Laminato Laminate:
Bianco Dax, Moro, Cloud, Noce Light, Lithos, Stone Black, Smoke
Bianco Dax, Moro, Cloud, Noce Light, Lithos, Stone Black, Smoke

Fenix Ntm® Fenix Ntm®:
Bianco Kos, Grigio Londra, Nero Ingo
Bianco Kos, Grigio Londra, Nero Ingo

Slim



Slim è un tavolo caratterizzato da una struttura in alluminio verniciato o anodizzato che sostiene un piano con prolunga in diverse finiture (vedi listino).

Il facile sistema telescopico allunga il tavolo fino a 240 cm e consente di ospitare fino a dieci commensali

Slim is a table featuring a painted or anodised aluminium structure on which rests a top with an extension in different finishes (see price list).

The simple telescopic extension system extends the table up to 240 cm and can seat up to ten people.

Slim est une table caractérisée par une structure en aluminium laqué ou anodisé qui soutient un plateau avec rallonge en différentes finitions (voir tarifs).

Le système télescopique simple allonge la table jusqu'à 240 cm et permet d'accueillir jusqu'à dix convives.

Slim es una mesa caracterizada por una estructura de aluminio pintado o anodizado que soporta una encimera con extensión en diferentes acabados (ver lista de precios).

El fácil sistema telescópico alarga la mesa hasta fino a 240 cm y permite albergar hasta diez comensales.



L-W 120 - 140 - 160 - 180 cm
+ 60 cm prolunga extension
P-D 90 cm
H-H 76 cm

FEELINGHome



_124_125



FINITURE - FINISHES - FINITIONS - ACABADOS

Struttura in alluminio verniciato - Varnished aluminum structure

Bianco opaco Matt White
Nero opaco Matt Black

Struttura in alluminio anodizzato - Anodised aluminum structure

Argento Silver

Piani e allungo - Tops and extension

Melaminico anta Melamine-faced door
Laminato HPL bordo ABS ABS HPL Laminate edging
Laminato HPL bordo Unicolor Unicolor HPL Laminate edging
Fenix Ntm® bordo Unicolor Fenix Ntm® Unicolor edging
Legni Woods: vedi listino consult price list

Plate



Struttura e piano in metallo verniciato Tops and structure in varnished metal



L-W 140 x 80 cm
L-W 150 x 150 cm
L-W 160 x 90 cm
L-W 220 x 100 cm
H-H 74 cm

Struttura in metallo verniciato e piano 12 mm Varnished metal structure and top 12mm th.



L-W 140 x 80 cm
L-W 150 x 150 cm (solo/only Corian e/and Gres)
L-W 160 x 90 cm
L-W 220 x 100 cm
H-H 74 cm

Il tavolo Plate dalla forma leggera ed essenziale è disponibile in due soluzioni. La prima con struttura e piano in metallo verniciato (Bianco, Nero o Grigio Fine), la seconda con struttura in metallo verniciato e piano da 12 mm.

Il piano prevede svariate finiture (vedi listino) per potersi abbinare alla cucina.

The Plate table with its lightweight and simple shape comes in two solutions. The first with a painted metal structure and top (Bianco, Nero or Grigio Fine), and the second with a painted metal structure and 12 mm top.

The top is available in a wide variety of finishes (see the price list) to match the finishes in the kitchen.

La table Plate à la forme légère et essentielle est disponible en deux solutions. La première avec structure en métal laqué (Bianco, Nero o Grigio Fine), la deuxième avec structure en métal laqué et plateau de 12 mm.

Le plateau prévoit différentes finitions (voir tarifs) pour pouvoir s'accorder aux finitions de la cuisine.

La mesa Plate de forma ligera y esencial está disponible en dos soluciones. La primera con estructura y encimera en metal pintado (Bianco, Nero o Grigio Fine), la segunda con estructura en metal pintado y encimera de 12 mm.

La encimera está disponible en una variedad de acabados (ver lista) para combinar con los acabados de la cocina.

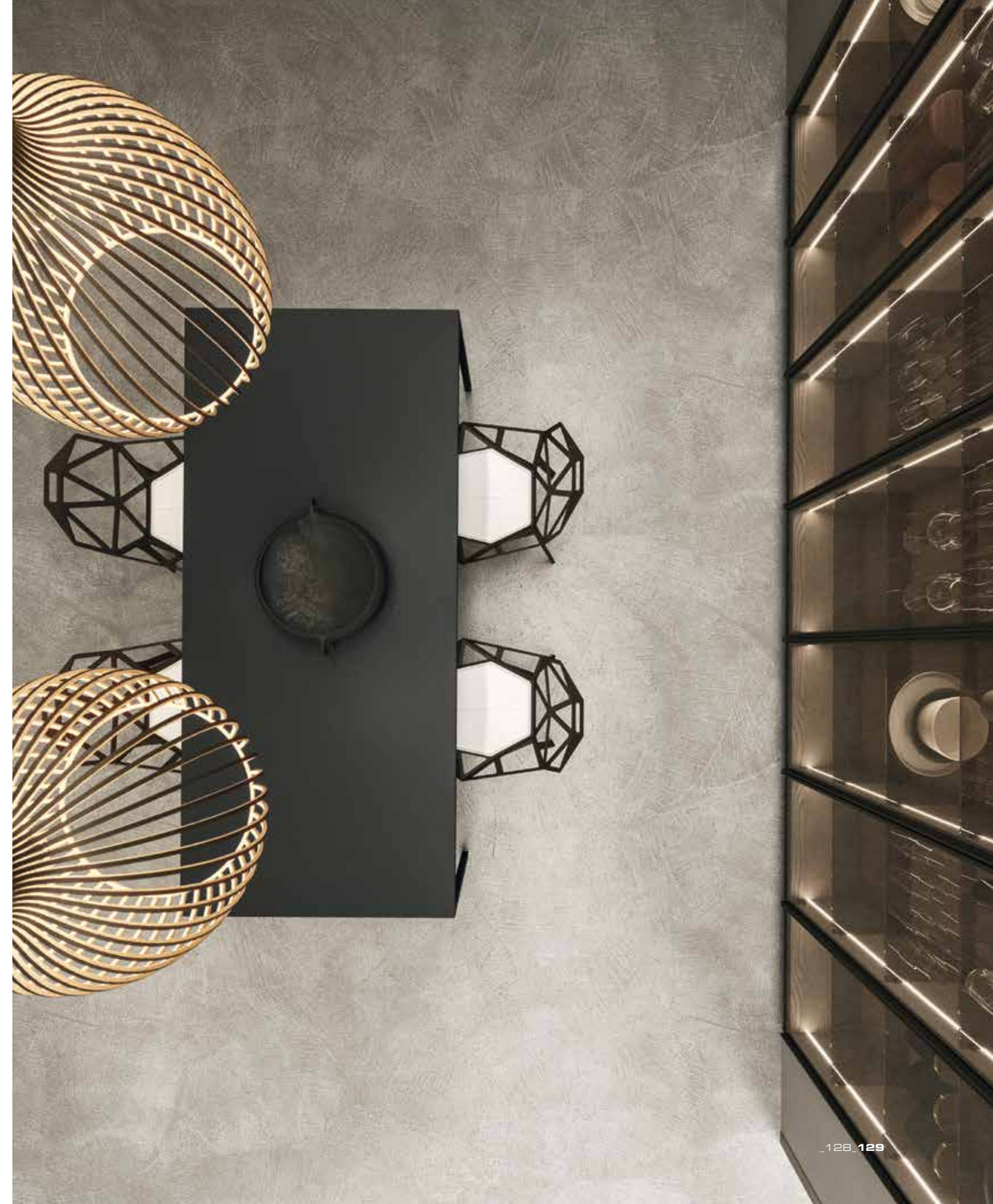



FINITURE - FINISHES - FINITIONS - ACABADOS

Struttura e piano - structure and plan

Bianco opaco Matt Bianco
Nero opaco RAL 9005 Matt Nero RAL 9005
Grigio Fine opaco Matt Grigio Fine

Piano spessore 12 mm - **Plan** 12 mm thick top

Fenix Ntm® Fenix Ntm®
Fenix Nta® Fenix Nta®
Laminato con bordo Unicolor Lam with Unicolor edge
Laminato con bordo ABS Lam with ABS edge
Laminato HPL stratificato Full Color Full Color HPL stratified laminate
Gres/MDI Gres/MDI: vedi listino consult price list



Linear



Struttura in metallo verniciato
Piano 18/20 mm in varie finiture

Painted metal structure
18/20-mm top in various finishes



L-W 120 - 130 - 140 - 160 cm
+ 40 cm prolunga extension
P-D 80 cm
H-H 75 cm

FEELINGHome

Linear è un tavolo dal design essenziale.
Con struttura in metallo verniciato può avere il piano da 20 o 18 mm in base alla finitura scelta. Dotato di prolunga da 40 cm può arrivare alla lunghezza massima di 200 cm.

Linear is a table with a pared-back design.
With a metal painted structure, it can have a 20 or 18 mm top depending on the chosen finish.
Featuring a 40 cm extension, it can reach a maximum length of 200 cm.

Linear est une table au design essentiel.
Avec une structure en métal laqué, elle est dotée d'un plateau de 20 ou 18 mm selon la finition choisie.
Pourvue d'une rallonge de 40 cm, elle peut atteindre une longueur maximale de 200 cm.

Linear es una mesa de diseño esencial.
Con estructura en metal pintado, la encimera puede tener un grosor de 20 o 18 mm, según el acabado elegido.
Dotada de alargador de 40 cm puede llegar a la longitud máxima de 200 cm.

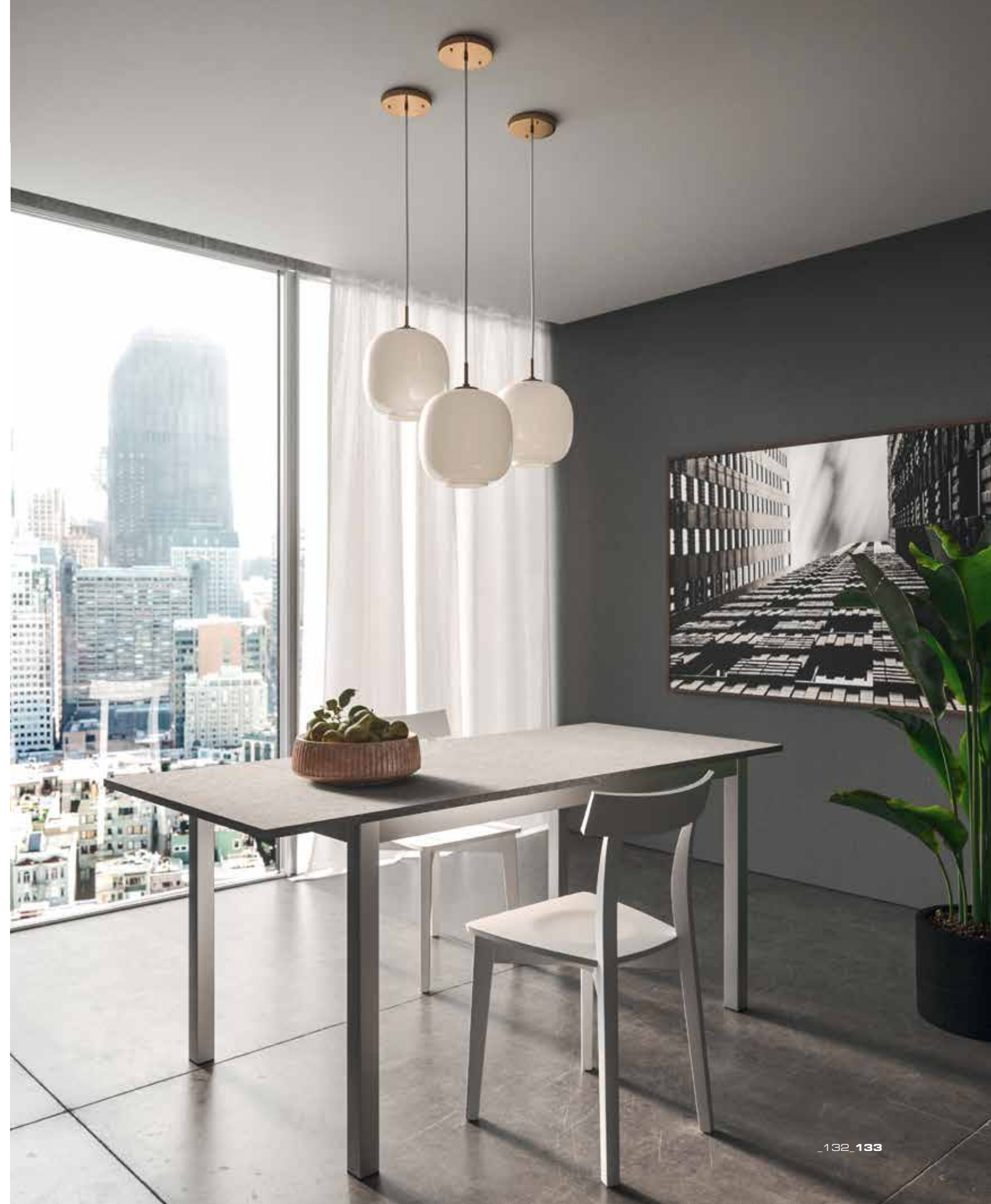

_132_133



FINITURE - FINISHES - FINITIONS - ACABADOS

Struttura in metallo verniciato - Varnished metal structure

Alluminio Aluminium
Bianco opaco Matt White
Nero opaco RAL 9005 Matt Black RAL 9005

Piano spessore 20 mm - **Plan** 20 mm thick top

Fenix Ntm® Fenix Ntm®
Fenix Nta® Fenix Nta®
Laminato con bordo Unicolor Lam with Unicolor edge
Laminato con bordo ABS Lam with ABS edge

Piano spessore 18 mm - **Plan** 18 mm thick top

Melaminico termostrutturato Melamine Thermoframed
Melaminico Supermatt Melamine Supermatt



Loft



Finiture Finishes:

Melaminico
Fenix Ntm® e Fenix Ntm® JTIME
Laminato HPL
Laccati: Lucidi/Sand, Soft-Touch, Ossidato e Metal
Legni: vedi listino

Melamine
Fenix Ntm® e Fenix Ntm® JTIME
Laminato HPL
Laquered: Glossy/Sand, Soft-Touch, Oxidized, Metal
Woods: consult price list

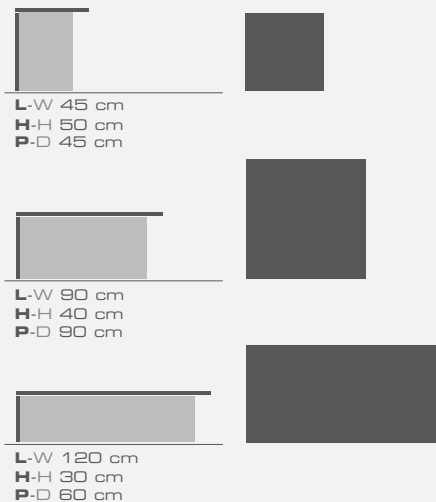

FEELINGHome

Linee pulite ed essenziali caratterizzano la serie di tavolini Loft. Progettati con diverse dimensioni e altezze possono essere usati singolarmente o accostati tra loro. L'utilizzo di due diverse finiture su ogni tavolino, oppure in monocolor, rende le composizioni cromaticamente sempre accattivanti.

Clean, clear-cut lines are the signature feature of the Loft coffee table series. Designed in different sizes and heights, they can be used individually or arranged together. The use of two different finishes on each coffee table, or a single colour, creates eye-catching colour compositions.

Des lignes épurées et essentielles caractérisent la série de tables basses Loft. Conçues avec différentes dimensions et hauteurs, elles peuvent être utilisées individuellement ou en version juxtaposée. L'utilisation de deux finitions différentes sur chaque table basse, ou de la même couleur, rend les compositions toujours fascinantes.

Líneas limpias y esenciales caracterizan la serie de mesitas Loft. Diseñadas con diferentes tamaños y alturas, pueden utilizarse individualmente o una al lado de la otra. El uso de dos acabados diferentes en cada mesa, o en un solo color, hace que las composiciones sean siempre cromáticamente atractivas.

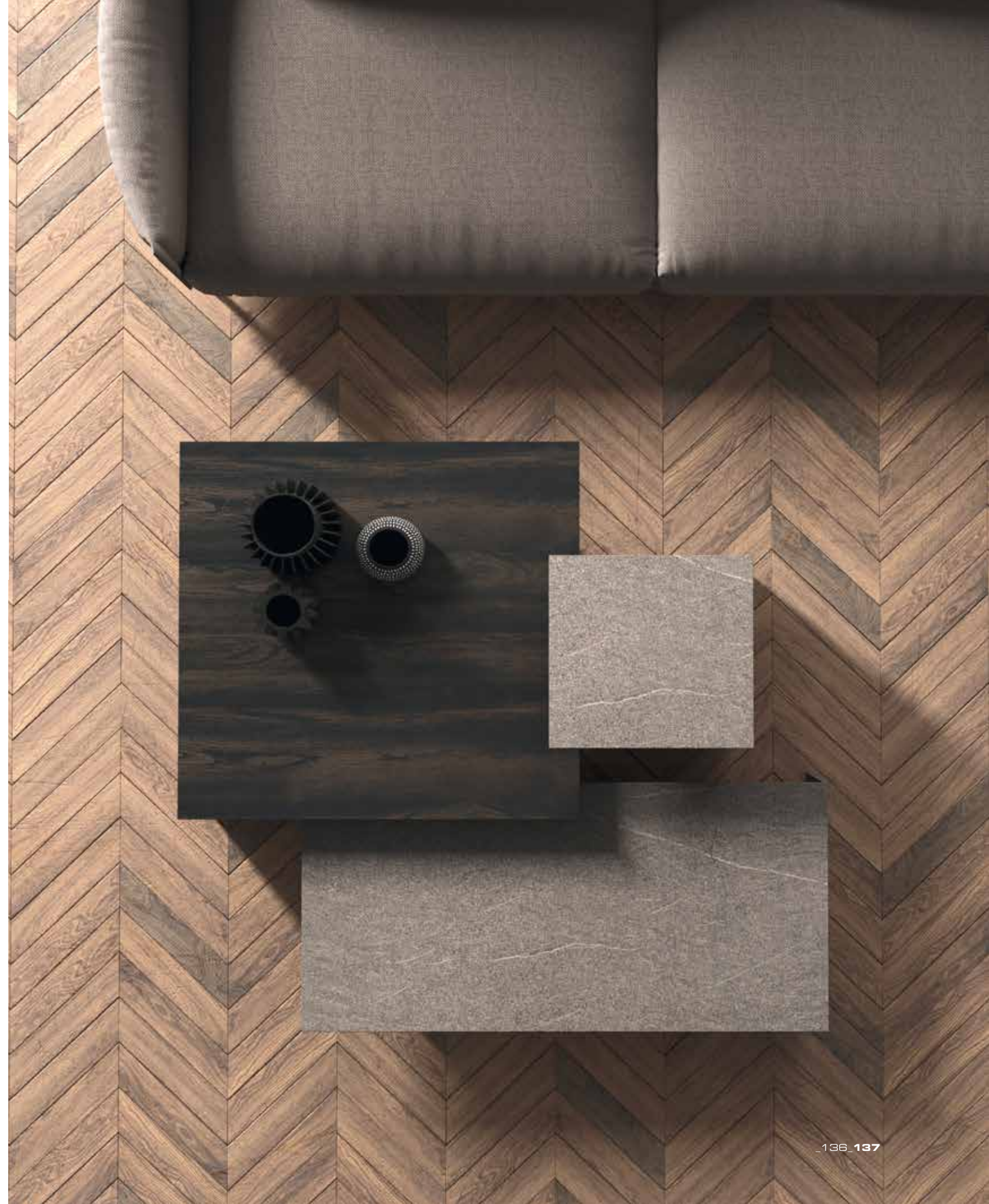



Panka



Finiture Finishes:

Rovere Tavolato: Naturale, Nuvola, Tatti, Avana, Cacao, Corteccia, Carbone, Trani, Biondo, Platino, Caramel, Portland, Ardesia
Olmo Sabbiato: Naturale, Grigio, Pepper, Moka
Noce Sabbiato: Fumo, Canaletto
Eucalipto Sabbiato: Grigio, Fumè
Olivo
Ebano opaco

Oak Plank: Naturale, Nuvola, Tatti, Avana, Cacao, Corteccia, Carbone, Trani, Biondo, Platino, Caramel, Portland, Ardesia
Olmo Sabbiato: Naturale, Grigio, Pepper, Moka
Noce Sabbiato: Fumo, Canaletto
Eucalipto Sabbiato: Grigio, Fumè
Olivo
Ebano opaco

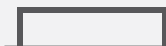

L-W 130 - 180 cm
H-H 45 cm
P-D 51 cm

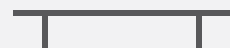

L-W 200 - 260 cm
H-H 45 cm
P-D 51 cm

FEELINGHome

La tradizionale panca, valorizzata nella sua semplicità e linearità, diventa oggetto d'arredo domestico. Viene proposta in svariate finiture (vedi listino) proprio per potersi armonizzare al contesto cucina/living.

The traditional bench, enhanced by its simple, linear design, becomes a household furnishing item. It is proposed in a variety of finishes (see the price list), ensuring that it blends seamlessly into any kitchen/living room setting.

Le banc traditionnel, mis en valeur dans sa simplicité et linéarité, devient un objet d'ameublement domestique. Il est proposé en différentes finitions (voir tarifs) précisément pour s'harmoniser avec l'espace cuisine/living.

El banco tradicional, realizado en su sencillez y linealidad, se convierte en un objeto de decoración doméstica. Propuesto en distintos acabados (ver lista) justo para poder armonizarse en el contexto cocina/living.





Finiture Finishes:

Faggio (no poro aperto):
 Scocca Nero + sedile paglia naturale
 Scocca Naturale + sedile paglia naturale

Ash wood (not open pore):
 Nero body + natural straw seat
 Naturale body + natural straw seat



L-W 50 cm
 H seduta H seat 46 cm
 H schienale H backrest 80 cm
 P-D 52,5 cm

L'aspetto elegante e l'armonia delle linee costruttive rendono Queeny la sedia perfetta per i diversi spazi della casa. La struttura è disponibile in finitura faggio naturale o laccato nero opaco mentre la seduta è sempre in paglia naturale.

The elegant look and balanced construction lines make Queeny the perfect chair for different areas in the home. The structure is available in a Natural ash wood or matt lacquered Nero finish while the seat is always in natural straw.

L'aspect élégant et l'harmonie de ses lignes font de Queeny la chaise parfaite pour les différents espaces de la maison. La structure est disponible en finition hêtre Naturelle ou laqué Nero mat tandis que l'assise est toujours en paille naturelle.

El aspecto elegante y la armonía de las líneas constructivas hacen de Queeny la silla perfecta para los distintos espacios de la casa. La estructura está disponible en acabado haya Naturale o lacado Nero opaco mientras que el asiento es siempre en paja natural.



Color



Finiture Finishes:

Faggio:
Laccato Nero opaco
Laccato Bianco opaco
Laccato Jaipur opaco
Laccato Grigio Londra opaco

Ash wood:
Matt lacquered Nero
Matt lacquered Bianco
Matt lacquered Jaipur
Matt lacquered Grigio Londra



L-W 42 cm
H seduta H seat 45,5 cm
H schienale H backrest 87,5 cm
P-D 47,5 cm



Color è la sedia della tradizione.
Realizzata con un unico materiale, ha come punto di forza la semplicità e la gamma cromatica con la quale viene proposta.

Color is a seat steeped in tradition.
Made from a single material, its strength lies in its simplicity and the colour range in which it is proposed.

Color est la chaise de la tradition.
Réalisée avec un seul matériau, son point fort se trouve dans sa simplicité et sa gamme de couleurs dans laquelle elle est proposée.

Color es la silla de la tradición.
Realizada con un único material, tiene como punto fuerte la simplicidad y la gama cromática con la cual se propone.

Logic



Finiture Finishes:

Monoscocca in polipropilene rinforzato con fibra di vetro.
Impilabile max 7 pz.

Bianco opaco
Nero opaco

Polypropylene monocoque structure reinforced with fibreglass.
Stackable max 7 pcs

Matt White
Matt Black



L-W 50,5 cm
H seduta H seat 45,8 cm
H schienale H backrest 80 cm
P-D 53 cm

FEELINGHome



Dalla forma avvolgente e super resistente Logic è una sedia dai lineamenti moderni ed ergonomici. Monoscocca in polipropilene viene proposta in due versioni colore, bianca o nera. La caratteristica di essere impilabile fino a sette pezzi, la rende ancora più versatile.

With its curved, hard-wearing design, Logic is a chair that showcases modern, ergonomic lines. The polypropylene monocoque structure comes in two colours, black or white. Up to seven chairs can be stacked together making it even more versatile.

Logic est une chaise à la forme enveloppante et super-résistante, aux lignes modernes et ergonomiques. Monobloc en polypropylène, elle est proposée en deux versions, blanche ou noire. Le fait de pouvoir empiler jusqu'à sept pièces la rend encore plus polyvalente.

De forma envolvente y súper resistente Logic es una silla de líneas modernas y ergonómicas. La monoestructura se propone en dos versiones color, blanco o negro. La característica de ser apilable hasta siete piezas la hace aún más versátil.

Slight



Finiture Finishes:

Sedile frassino poro aperto:
Nero
Bianco
Struttura metallo verniciato:
Nero
Bianco

Open pore ash wood seat:
Black
White
Painted metal structure:
Black
White

Esile ed elegante lo sgabello Slight si evidenzia per i contorni delicati.
La struttura in metallo verniciato bianco o nero sostiene un sedile circolare in frassino, laccato a poro aperto in tinta.

The graceful and elegant Slight stool has a signature delicate outline.
The white or black painted metal structure supports the round ash wood seat, with matching open pore lacquered finish.

Fin et élégant, le tabouret Slight est marqué par des contours délicats.
La structure en métal laqué blanc ou noir soutient une assise circulaire en hêtre, laqué à ports ouverts de la même couleur.

Delgado y elegante el taburete Slight se destaca por sus delicados contornos.
La estructura de metal pintado en blanco o negro sostiene un asiento circular de fresno, lacado de poro abierto en el mismo color.



L-W 37,5 cm
H-H 67,7 cm
□ seduta □ seat 37,5 cm





Finiture Finishes:

Gambe e sedile in frassino:
Nero poro aperto
Bianco RAL 9010

Ash wood legs and seat:
Open pore black:
White RAL 9010

Lo sgabello Tacky, regolabile in altezza grazie ad un perno centrale a vite, viene proposto con gambe e sedile circolare in frassino naturale o laccato nero.

The Tacky stool with a height-adjustable, central screw, features the legs and seat in natural or lacquered black ash wood.

Le tabouret Tacky, réglable en hauteur grâce à un pivot central à vis, est proposé avec des pieds et une assise circulaire en hêtre naturel ou laqué noir.

El taburete Tacky, ajustable en altura gracias a un perno central con tornillo, se propone con patas y asiento circular en fresno natural o lacado negro.



L-W 54 cm
H-H min. 62 max 72 cm
□ seduta Ø seat: 35 cm



Le finiture qui di seguito riportate sono dedicate alla **collezione k_Lounge**.

La ricerca dei materiali più evoluti e delle nuance più attuali ha dato vita a questa palette.

Passando dai Termostrutturati ai Fenix®, ai Laccati, si riescono ad esaltare le qualità estetiche, funzionali e cromatiche delle soluzioni d'arredo.

The finishes listed below are dedicated to the **k_Lounge collection**.

The search for cutting-edge materials and on-trend colours has resulted in this palette.

Ranging from thermo-structured materials to Fenix® and lacquered finishes, it is possible to enhance the aesthetic, functional and colour qualities of the furnishing solutions.

Les finitions indiquées ci-après sont dédiées à la **collection k_Lounge**.

La recherche des matériaux les plus avancés et des teintes les plus actuelles a donné vie à cette palette de couleurs.

Des Thermostructurés aux Fenix®, en passant par les laques, les qualités esthétiques, fonctionnelles et chromatiques des solutions d'aménagement peuvent être mises en valeur.

Los siguientes acabados están dedicados a la **colección k_Lounge**.

La búsqueda de los materiales más avanzados y los matices más actuales ha dado lugar a esta paleta.

Pasando de los Termoestructurados a los Fenix, a los lacados se logran exaltar las cualidades estéticas, funcionales y cromáticas de las soluciones de amueblado.



Finishes k-Lounge

MELAMINICO TERMOSTRUTTURATO

MELAMINE THERMOFRAMED - MÉLAMINE THERMOSTRUCTURED - MELAMINICO TERMOESTRUCTURADO

Poro registro

Poro registro - Poro registro - Poro registro



Sugar

Sherwood

Smoke

Sabbiato

Sabbiato - Sablé - Sabbiato



Riso

Sesamo

Fox

Paglia



Rovere Fanes

Noce Light

Basalto

Moro

Materico

Textured - Matériel - Materico



Wall73

Wall45

Wall51

Wall08



Lapis

Lithos

Stone Grey

Stone Black

Texture

Texture - Texture - Texture

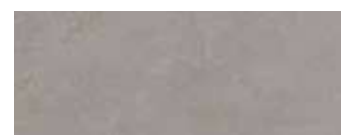

Cloud

MELAMINICO SUPERMATT

SUPERMATT MELAMINE - MÉLAMINE SUPERMATT - MELAMINICO SUPERMATT



Polar

Seta

Avorio

Grigio Segnale



Bruma

Dolphin

Grigio Ferro

LAMINATO HPL

LAMINATE HPL - LAMINE HPL - LAMINADO HPL



Bianco Dax

Argilla

Grey 160

Cemento Portland

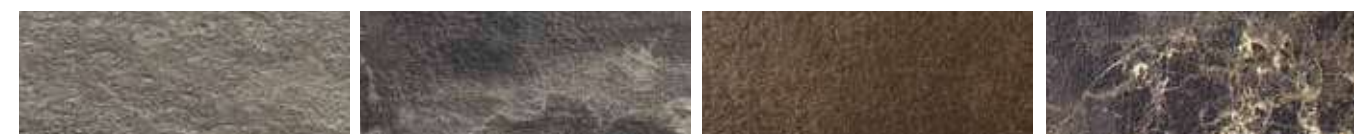

Nocturne

Canova 434

Ossido 146

Emperador



Cesar Brown Stone

Nero Tecno

FENIX NTM®

FENIX NTM® - FENIX NTM® - FENIX NTM®



Bianco Kos

Grigio Londra

Nero Ingo

FENIX NTM® JTIME

FENIX NTM® JTIME - FENIX NTM® JTIME - FENIX NTM® JTIME



Bianco Malè **Grigio Efeso** **Beige Arizona** **Castoro Ottawa**



Grigio Antrim **Grigio Bromo** **Verde Comodoro** **Jaipur**



Titanio Doha **Bronzo Doha** **Piombo Doha**

FINITURE LEGNO

WOOD FINISHES - FINITION BOIS - ACABADO MADERA

Rovere Spazzolato

Brushed Oak - Chêne brossé - Roble Cepillado



Nuvola **Tatti** **Caramel** **Portland**



Naturale **Avana** **Corteccia** **Cacao**

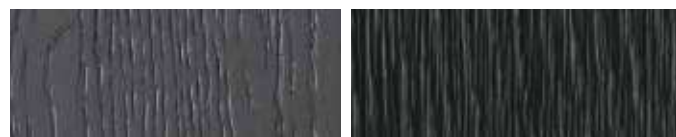

Ardesia **Carbone**

Olmo Sabbiato



Naturale **Grigio** **Pepper** **Moka**

Noce Sabbiato



Fumo

Noce



Noce Canaletto

Eucalipto Sabbiato



Grigio **Fumè**

Ebano



Ebano opaco

Olivo



Olivo opaco

Abete Tinto



Sciliar **Vigo** **Ortisei**

LACCATO SOFT TOUCH

SOFT TOUCH LAQUERED - LAQUÉ SOFT TOUCH - LACADO SOFT TOUCH

**Arena ST****Grigio fine ST****Ardesia ST****Nero ST****LACCATO OSSIDATO**

OXIDISED LAQUERED - LAQUÉ OXIDÉ - LACADO ÒXIDADO

**Ossidato gold****Ossidato ottone****Ossidato bronzo****Ossidato ghisa****Ossidato acciaio****Ossidato piombo****LACCATO METAL**

METAL LAQUERED - LAQUÉ METAL - LACADO METAL

**Metal champagne****Metal rame****Metal grafite****Metal brown****LACCATI LUCIDI/SAND**

LACQUERED GLOSSY/SAND - LAQUE BRILLANT/SAND - LACADO BRILLANT/SAND

**Bianco Puro****Bianco Crema
Ral 9001****Mandorla
NCS S 1502-Y50R****Nube****Grigio Fine****Grigio Londra****Grigio Medio
Ral 000.45.00****Grigio
Ral 7043****Ardesia****Nero
Ral 9005****Grigio Chiaro
Ral 000.80.00****Glicine****Minio****Jaipur****Fango****Arena
Ral 060.60.05****Nocciola****Castoro Ottawa****Rosmarino****Petrolio
Ral 230.30.20****RAL / NCS**

Arrital s.r.l., si riserva di apportare in qualsiasi momento e senza preavviso, le modifiche ritenute opportune al fine di migliorare le caratteristiche qualitative e tecniche della propria produzione, inoltre le ambientazioni sono a puro titolo esemplificativo e non sono vincolanti in alcun modo per l'Azienda. Le immagini stampate in questo catalogo, possono non rappresentare fedelmente le tinte reali ed eventuali effetti materici dei nostri materiali; per questo motivo si potranno riscontrare differenze di toni.

Arrital s.r.l. reserves the right to modify product specifications without notice. The kitchen settings are only for illustrative purposes and can not bind the company in any way. The images shown in this catalogue may not accurately represent the real finishes or textured effects of our materials.

Arrital s.r.l., se réserve d'apporter à tout moment et sans préavis, des modifications retenues opportunes afin d'améliorer les caractéristiques qualitatives et techniques de sa production. En outre, les implantations sont faites à titre d'exemple et ne sont en aucun cas contraignantes pour la Société. Les images imprimées dans ce catalogue peuvent ne pas correspondre exactement aux teintes réelles et aux effets visuels des matériaux. Pour cette raison, il est possible d'avoir des différences de tonalité.

Arrital s.r.l. se reserva el derecho de aportar sin aviso previo cambios o modificaciones al producto cuando lo considera oportuno al fin de mejorar las características técnicas y cualitativas de su propia producción. Las imágenes de este catalogo pueden no representar fielmente los colores reales y eventuales efectos matericos de los materiales.

Thanks To

ARTEMIDE
BAXTER
CARL HANSEN
CASSINA
DAVIDE GROPPI
FLEXFORM
FLOS
FOCUS
FOSCARINI
FRITZ HANSEN
KARTELL
KNOLL
LIGHTDROPS DESIGN
LIVING DIVANI
MAGIS
MINOTTI
MOROSO
OLUCE
PORADA
VESCO
ZANOTTA

Design and Art Direction
Arch. FRANCO DRIUSSO

Graphic design
DRIUSSOASSOCIATI | ARCHITECTS

Images Production
Nerokubo

Color Separation
Luce Group

Printed
Grafiche Antiga Spa 05/2021



Arritel srl
Via Casut, 103
33074 Fontanafredda (Pn) Italy
T 0434 / 567411
F 0434 / 999728-999848-569995

