

/Dògma/



NEW RULES
FOR THE MODERN BATHROOM

/Dogma/

NEW RULES FOR THE MODERN BATHROOM

IT. Dogma inteso come nuova filosofia progettuale, come nuovo pensiero capace di riscrivere il concetto di design e di emozione legati all'ambiente bagno.

EN. Dogma is a new style philosophy, a new approach that redefines the concept of design and comfort associated with the bathroom.

DE. Dogma ist eine neue Stilphilosophie, ein neuer Ansatz, der die Konzepte des Designs und der Emotionen, die mit dem Badezimmerambiente verbunden sind, neu definiert.

FR. Dogma est une nouvelle philosophie conceptuelle, une nouvelle approche qui redéfinit les concepts de design et d'émotion liés à l'univers de la salle de bains.

ES. Dogma entendido como nueva filosofía de proyecto, como una nueva idea que repropone el concepto de diseño y emoción vinculado con el cuarto de baño.

design.

**Il design è protagonista.
Estetica pura e
funzionale. / Design is the
true protagonist: pure,
functional aesthetics.**

Lavabo/Washbasin "Dogma"

IT. Connubio tra estetica ed ergonomia. **EN.** Good looks and ergonomics perfectly combined. **DE.** Eine perfekte Kombination zwischen Ästhetik und Ergonomie. **FR.** Esthétique et ergonomie parfaitement combinées. **ES.** Combinación entre estética y ergonomia.

Marmo/Marble

IT. Materiali nobili e suggestivi.
EN. Noble, evocative materials.
DE. Edle, effektvolle Materialien.
FR. Des matériaux nobles et suggestifs.
ES. Materiales nobles y atractivos.

Argomenti della Collezione / Collection's plus

Essenza/Essence

IT. L'eleganza della finitura Rovere Termocotto.
EN. The elegance of the Rovere Termocotto finish. **DE.** Die Eleganz der Ausführung Rovere Termocotto. **FR.** L'élégance de la finition Rovere Termocotto. **ES.** La elegancia del acabado Rovere Termocotto.

Gres/Stoneware

IT. Il Gres viene applicato anche ai frontali.
EN. We have chosen stoneware for our fronts too. **DE.** Wir haben uns auch für die Fronten für Steinzeug entschieden. **FR.** Le grès a été choisi pour les façades aussi. **ES.** El gres se aplica también en las partes frontales.

Dogma
D

Index

d.01



d.02



d.03



d.04



d.05



d.06



d.07



d.08



d.09



d.10



d.11



d.12



d.13



d.01





d.01

L 280 x P 50/18 cm - Rovere Naturale, Gres Statuario

Composizione / Composition

IT. Effetto Marmo, effetto legno. Unione seducente dalla forte ispirazione naturale, dal grande impatto scenico. La bellezza attraversa le azioni del quotidiano.

EN. Marble and wood finish: a strong, captivating combination of natural materials creates a sensational visual effect. Beauty identifies our daily bathroom rituals.

DE. Ausführung Marmor und Holz. Die starke, verführerische Kombination aus natürlichen Materialien schafft eine sensationelle optische Wirkung. Unsere täglichen Badezimmer-Rituale sind von Schönheit geprägt.

FR. Effet marbre et bois : l'association forte et séduisante des matériaux naturels crée un grand impact visuel. La beauté caractérise nos rituels au quotidien.

ES. Efecto mármol y efecto madera. Unión seductora de intensa inspiración natural y gran impacto escénico. La belleza atraviesa las acciones de la vida cotidiana.

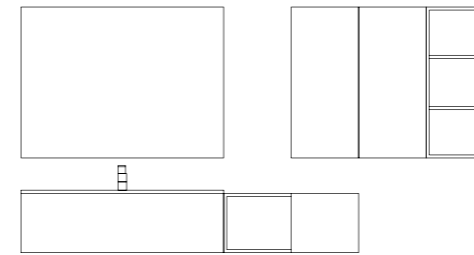

280 cm

IT. Dettaglio Piano con Lavabo integrato Dogma in Cristalplant. Spessore 1,5 cm. **EN.** Detail of 1.5 cm thick Cristalplant Dogma top with integrated washbasin. **DE.** Detail der 1,5 cm starken Platte Dogma aus Cristalplant mit integriertem Waschbecken. **FR.** Détail du plan de toilette avec vasque intégrée Dogma en Cristalplant. Épaisseur 1,5 cm. **ES.** Detalle de la encimera con lavabo integrado Dogma de Cristalplant. Espesor 1,5 cm.

01.dettaglio/detail



IT. ↑ Detail of Rovere Naturale open compartment.
Detail of wall units with matt Gres Staturario fronts. →
Dettaglio Colonne con frontali in Gres Staturario Opaco.

EN. ↑ Detail of Rovere Naturale open compartment.
→ Detail of wall units with matt Gres Staturario fronts.

DE. ↑ Detail des offenen Elements aus Rovere
Naturale. → Detail der Hochschranke mit Fronten aus
Gres Staturario matt.

FR. ↑ Détail du compartiment ouvert en Rovere
Naturale. → Détail des colonnes avec façades en Gres
Staturario mat.

ES. ↑ Detalle del espacio abierto en Rovere Naturale.
→ Detalle de las columnas con frontales de Gres
Staturario mate.



d.02





IT. Dettaglio Piano con Lavabo integrato Dogma in Cristalplant. Spessore 1,5 cm. **EN.** Detail of 1.5 cm thick Cristalplant Dogma top with integrated washbasin. **DE.** Detail der 1,5 cm starken Platte Dogma aus Cristalplant mit integriertem Waschbecken. **FR.** Détail du plan de toilette avec vasque intégrée Dogma en Cristalplant. Épaisseur 1,5 cm. **ES.** Detalle de la encimera con lavabo integrado Dogma de Cristalplant. Espesor 1,5 cm.

d.02

L 160 x P 50 cm - Rovere Termocotto

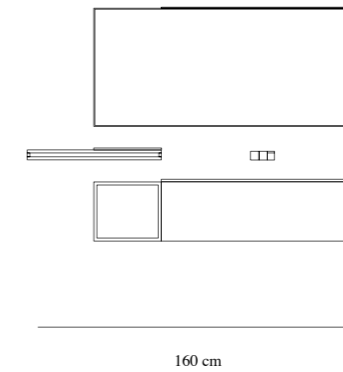

Composizione / Composition

IT. Un dialogo stilistico che ridisegna la stanza da bagno, ispirazioni capaci di evolvere insieme a chi le vive e le abita.

EN. Style characterizes the mood of this bathroom, where design evolves to meet your changing requirements.

DE. Dieses Badezimmer unterscheidet sich durch Stil. Das Design passt sich den wechselnden Anforderungen an.

FR. Ce dialogue stylistique redéfinit la salle de bains où le design évolue pour satisfaire vos exigences qui se transforment.

ES. Un diálogo estilístico que rediseña el cuarto de baño, inspiraciones capaces de evolucionar junto con quien las vive.

02.dettaglio/detail



IT. ↑ Dettaglio Portasciugamano con struttura in alluminio verniciata Carbone con piccola Mensola in Cristalplant. → Dettaglio Specchiera Frame con profilo rivestito in Rovere Termocotto e Lampada Minimal.

EN. ↑ Detail of towel rail with Carbone painted aluminium frame and Cristalplant shelf. → Detail of Frame mirror with Rovere Termocotto wrapped profile and Minimal lamp.

DE. ↑ Detail des Handtuchhalters mit lackierter Aluminiumstruktur Carbone mit Konsole aus Cristalplant. → Detail des Spiegels Frame mit Profil mit Beschichtung aus Rovere Termocotto und Lampe Minimal.

FR. ↑ Détail du porte-serviettes avec structure en aluminium peinte Carbone avec étagère en Cristalplant. → Détail du miroir Frame avec profilé revêtu en Rovere Termocotto et lampe Minimal.

ES. ↑ Detalle del toallero con estructura de aluminio pintada Carbone con estante de Cristalplant. → Detalle del espejo Frame con perfil revestido en Rovere Termocotto y lámpara Minimal.



02.dettaglio/detail



IT. Dogma come complesso di equilibrio e contrasti, come ricerca ed armonia dell'insieme.

FR. Dogma comme complexe d'équilibres et de contrastes, comme recherche et harmonie de l'ensemble.

EN. A Dogma bathroom is made of perfectly balanced contrasts that create a sophisticated, harmonious environment.

ES. Dogma crea un complejo de equilibrio y contrastes, que apuesta por la armonía del espacio.

DE. Ein Dogma Badezimmer besteht aus perfekt ausgewogenen Kontrasten, die ein elegantes, harmonisches Ambiente entstehen lassen.

d.03





d.03

L 240 x P 50/18 cm - Laccato Bianco opaco

Composizione / Composition

IT. Parallelismi e dinamismo. Rappresentazioni dell'abitare moderno, dove il progetto d'arredo diventa espressione diretta dell'incrocio tra gusti e stili di vita.

EN. Parallelism blends with dynamism: these examples of modern living environments show that furnishing projects can adapt successfully to personal tastes and lifestyle requirements.

DE. Eine Mischung aus Parallelismus und Dynamik. Diese Beispiele eines modernen Wohnambientes zeigen, dass Einrichtungsprojekte sich dem individuellen Geschmack und Lebensstil anpassen können.

FR. Parallélisme et dynamisme combinés : des représentations d'habitat contemporain où les projets de décoration s'adaptent parfaitement aux modes de vie et goûts personnels.

ES. Paralelismos y dinamismo. Representaciones del moderno habitar, donde el proyecto decorativo se convierte en expresión directa entre los gustos y el estilo de vida.

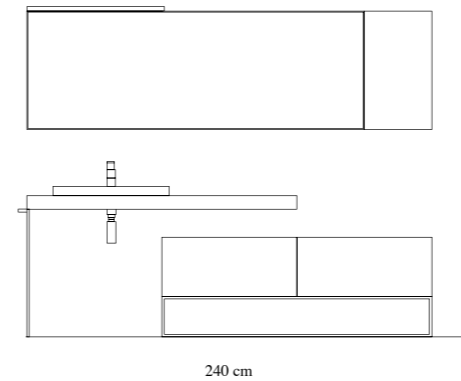

IT. Dettaglio Lavabo semi incasso in Marmo Grafite Opaco su Piano Abete vintage Sbiancato. **EN.** Detail of Abete Vintage Sbiancato top with matt Grafite marble semi-inset washbasin. **DE.** Detail des Halbeinbau-Waschbeckens aus Marmor Grafite matt auf Platte Abete Vintage Sbiancato. **FR.** Détail de la vasque semi-encastree en marbre Grafite mat sur plan de toilette Abete Vintage Sbiancato. **ES.** Detalle del lavabo semiempotrado en mármol Grafite mate sobre encimera Abete Vintage Sbiancato.



IT. Dettaglio su elemento strutturale in alluminio verniciato in finitura Carbone. **EN.** Detail of structural element in Carbone painted aluminium. **DE.** Detail des Strukturelements aus lackiertem Aluminium in der Ausführung Carbone. **FR.** Détail de l'élément structurel en aluminium peint dans la finition Carbone. **ES.** Detalle del elemento estructural de aluminio pintado en acabado Carbone.



IT. Dettaglio doppio cassetto su base in finitura Laccato Bianco Opaco. Il cassetto superiore è a scomparsa.

EN. Detail of matt Bianco lacquered base unit with 1 deep drawer and 1 top concealed drawer.

DE. Detail der doppelten Schublade auf Unterschrank in der lackierten Ausführung Bianco matt. Die obere Schublade ist verdeckt.

FR. Détail du double tiroir sur base dans la finition laqué Bianco mat. Le tiroir supérieur est intégré.

ES. Detalle del doble cajón sobre base en acabado lacado Bianco mate. El cajón superior es escamoteable.

d.04





d.04

L 280 x P 50 cm - Rovere Termocotto

Composizione / Composition

IT. Accostamento forte di materiali. Il mobile da bagno rappresenta fonte di ispirazione, capace di dettare lo stile e di identificare un gusto da estendere al mood abitativo.

EN. A fascinating combination of materials: bathroom furniture has become a source of inspiration, able to determine and identify the style of the entire home.

DE. Eine faszinierende Kombination von Materialien. Das Badezimmermöbel stellt eine Inspirationsquelle dar, die den Stil des ganzen Hauses bestimmen und identifizieren kann.

FR. Une association attrayante de matériaux : le meuble de salle de bains représente une source d'inspiration, capable de définir et d'identifier le style de toute la maison.

ES. Combinación fascinante de los materiales. El mueble del cuarto de baño representa una fuente de inspiración, que dicta un estilo e identifica un gusto que se extiende al resto de la habitación.



280 cm

IT. Dettaglio Lavabo in Marmo Carrara, spessore 13 cm. **EN.** Detail of 13 cm thick Carrara Marble washbasin. **DE.** Detail des 13 starken Waschbeckens aus Carrara Marmor. **FR.** Détail de la vasque en marbre Carrara, épaisseur 13 cm. **ES.** Detalle del lavabo en mármol de Carrara de 13 cm de espesor.

**Dialogo perfetto tra
estetica ed equilibrio
compositivo. / The perfect
combination of good looks
and balanced style.**





**L'estrema cura del dettaglio.
In ogni elemento. / Every single
element reveals painstaking care
for details.**

IT. Dettaglio cassetto aperto dove anche l'interno si presenta in finitura Rovere Termocotto **EN.** The drawer has a beautiful Rovere Termocotto finish both inside and outside. **DE.** Detail der offenen Schublade, deren Innenseite ebenfalls die Ausführung Rovere Termocotto aufweist. **FR.** Détail du tiroir ouvert qui a une splendide finition Rovere Termocotto tant à l'intérieur qu'à l'extérieur. **ES.** Detalle del cajón abierto. También el acabado de la parte interna es de Rovere Termocotto.



d.05

**Dogma, tra design
e funzionalità.
/ Design and
functionality go
hand in hand.**



IT. Dettaglio Piano con Lavabo integrato Dogma in Cristalplant. Spessore 12 cm. **EN.** Detail of 12 cm thick Cristalplant Dogma top with integrated washbasin. **DE.** Detail der 12 cm starken Platte Dogma aus Cristalplant mit integriertem Waschbecken. **FR.** Détail du plan de toilette avec vasque intégrée Dogma en Cristalplant. Épaisseur 12 cm. **ES.** Detalle de la encimera con lavabo integrado Dogma de Cristalplant. Espesor 12 cm.

d.05

L 120 x P 50+L 40 x P 28 cm

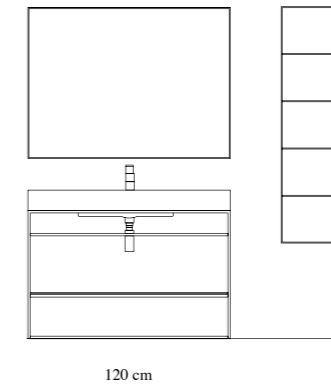

Composizione / Composition

IT. Dogma, tra design e funzionalità. Linee estetiche che diventano espressione di originalità progettuale definita da una sostanziale purezza di forme.

EN. The Dogma collection stands for the perfect mix of design and functionality. Appealing lines beautifully express the original design and pure shapes of this furnishing solution.

DE. Die Dogma-Kollektion steht für die perfekte Mischung aus Design und Funktionalität. Ansprechende Linien prägen das originelle Design und die reinen Formen dieser Einrichtungslösung.

FR. Dogma, entre design et fonctionnalité. Les lignes esthétiques expriment merveilleusement l'originalité conceptuelle et la pureté des formes de cette solution d'ameublement.

ES. Dogma, entre diseño y funcionalidad. Líneas estéticas que son la expresión de la originalidad del diseño, representada por una pureza sustancial de las formas.

Geometrie, incastri, estetica non convenzionale. / Geometric, embedded shapes; unconventional beauty.

IT. Dettaglio Struttura in alluminio verniciata in finitura Carbone. Ripiano spessore 6 mm in finitura Rovere Laccato Bianco poro aperto. **EN.** Detail of Carbone painted aluminium frame with 6 cm thick top with a matt open-pore Bianco lacquered finish. **DE.** Detail der Struktur aus lackiertem Aluminium in der Ausführung Carbone. 6 mm starke Platte in der Ausführung Rovere Bianco offenporig lackiert. **FR.** Détail de la structure en aluminium peinte dans la finition Carbone. Étagère, épaisseur 6 mm, dans la finition Rovere laqué Bianco à pore ouvert. **ES.** Detalle de la estructura de aluminio pintada en acabado Carbone. Estante de 6 mm de espesor en acabado Rovere lacado Bianco de poro abierto.



L.120cm



**Lavabo/Washbasin
Dogma in Cristalplant**

IT. Lavabo dal design esclusivo firmato IdeaGroup. **EN.** Ideagroup exclusive design washbasin. **DE.** Waschbecken mit exklusivem Design von Ideagroup. **FR.** Vasque au design exclusif d'Ideagroup. **ES.** Lavabo de diseño exclusivo firmado Ideagroup.

**L.120cm
Vasca completa
/Full bowl**



L.60cm



L.80cm

L.100cm



d.06

Si racconta qualcosa di concretamente differente. / It's all about something entirely different.



d.06

L 160 x P 50/36 cm - Rovere Termocotto

Composizione / Composition

IT. È lo spirito progettuale che identifica la vera novità. Dalle linee compositive, all'alternanza di pieni e vuoti. Si racconta qualcosa di concretamente differente.

EN. It's the design spirit that identifies true innovative trends. Clean lines blend with a beautiful alternation of full and empty spaces. In the end, it's all about a totally different furnishing style.

DE. Die innovativen Trends werden vom Design geprägt. Die saubere Linienführung wird mit der Abwechslung von leeren und vollen Fächern kombiniert. Schließlich dreht sich alles um einen völlig anderen Einrichtungsstil.

FR. C'est l'esprit conceptuel qui identifie les véritables innovations. Les lignes pures sont alliées à une magnifique alternance d'espaces pleins et vides. De fait, il s'agit d'un style d'ameublement totalement différent.

ES. El espíritu del diseño que identifica la auténtica novedad. Las líneas de composición que se alternan con los espacios llenos y vacíos. Se logra una concreta diferencia.

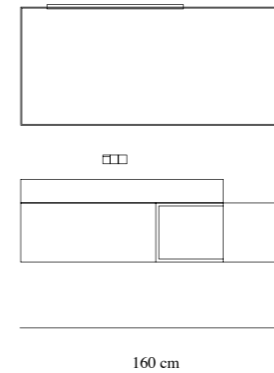

IT. I materiali sono i veri protagonisti. La prospettiva racconta spessori e profondità. **EN.** Materials with varying thicknesses and depths are the true protagonists of this bathroom furnishing solution. **DE.** Im Mittelpunkt dieser Badezimmerlösungen stehen Materialien mit verschiedenen Stärken und Tiefen. **FR.** Les matériaux sont les vrais protagonistes avec leurs différentes épaisseurs et profondeurs. **ES.** Los materiales son los auténticos protagonistas. La perspectiva cuenta de espesores y profundidades.

06.dettaglio/detail



IT. Dettaglio Piano con Lavabo integrato in Gres Staturario Opaco. Spessore 14 cm. **EN.** Detail of 14 cm thick matt Gres Staturario top with integrated washbasin. **DE.** Detail der 14 cm starken Platte Gres Statuario matt mit integriertem Waschbecken. **FR.** Détail du plan de toilette avec vasque intégrée en Gres Staturario mat. Épaisseur 14 cm. **ES.** Detalle de la encimera con lavabo integrado de Gres Staturario mate. Espesor 14 cm.



IT. Dettaglio Specchiera Frame con profilo rivestito in Rovere Termocotto e Lampada Minimal.

EN. Detail of Frame mirror with Rovere Termocotto wrapped profile and Minimal lamp.

DE. Detail des Spiegels Frame mit Profil mit Beschichtung aus Rovere Termocotto und Lampe Minimal.

FR. Détail du miroir Frame avec profilé revêtu en Rovere Termocotto et lampe Minimal.

ES. Detalle del espejo Frame con perfil revestido en Rovere Termocotto y lámpara Minimal.



d.07





IT. Dettaglio Struttura in alluminio di appoggio verniciata in finitura Bianco. **EN.** Detail of floor-standing frame in Bianco painted aluminium. **DE.** Detail der freistehenden Struktur in der lackierten Ausführung Bianco. **FR.** Détail de la structure en aluminium d'appui peinte dans la finition Bianco. **ES.** Detalle de la estructura de aluminio de apoyo pintada en acabado Bianco.

d.07

L 160 x P 50 cm - Rovere Naturale

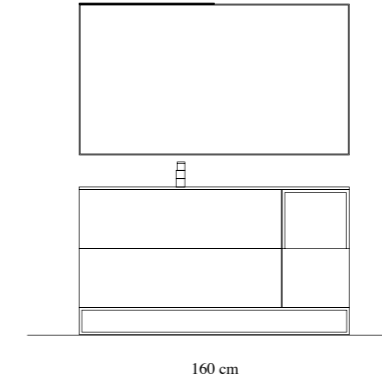

Composizione / Composition

IT. Architettura progettuale essenziale. Estrema linearità, pulizia geometrica. La semplicità diventa un valore aggiunto senza compromettere il binomio estetica e funzione.

EN. Streamlined design solutions. Sleek lines go hand in hand with clean geometric shapes. Without ever compromising on good looks and functionality, simplicity becomes an added value.

DE. Schlichte Design-Lösungen. Schlanke Linien gehen Hand in Hand mit sauberen geometrischen Formen. Schlichtheit wird zu einem Mehrwert, ohne die schöne Optik und die Funktion zu beeinträchtigen.

FR. Architecture conceptuelle essentielle. Des lignes épurées combinées à des formes géométriques nettes. La simplicité devient une valeur ajoutée sans jamais compromettre le binôme esthétique et fonctionnalité.

ES. Arquitectura de diseño esencial. Máxima linealidad y esencialidad geométrica. La sencillez se convierte en un valor añadido sin comprometer la armonía entre estética y función.



IT. ← Dettaglio della Base e del vano a giorno in Rovere Naturale. ↑ Dettaglio vano a giorno con particolare giunzione sartoriale. **EN.** ← Detail of Rovere Naturale base and open unit. ↑ Detail of open compartment with meticulously crafted joints. **DE.** ← Detail des Unterschranks und des offenen Elements aus Rovere Naturale. ↑ Detail des offenen Elements mit sorgfältig verarbeiteten Verbindungsstellen. **FR.** ← Détail de la base et du compartiment ouvert en Rovere Naturale. ↑ Détail du compartiment ouvert avec joints réalisés avec soin artisanal. **ES.** ← Detalle de la base y del espacio abierto en Rovere Naturale. ↑ Detalle del espacio abierto con uniones artesanales.

d.08





d.08

L 280 x P 50/36/18 cm - Laccato Nero opaco, Gres Marquinia opaco

Composizione / Composition

IT. Diversi spessori e diverse profondità identificano la voglia di osare e di sperimentare. L'obiettivo è ricreare uno spazio dinamico, fortemente caratterizzante, decisamente contemporaneo.

EN. Varying thicknesses and depths express our yearning to dare and experiment. Our goal is to create a dynamic, distinguishing environment that is unmistakably contemporary.

DE. Unterschiedliche Dicken und Tiefen drücken unsere Experimentierfreude aus. Unser Ziel ist es, ein dynamisches, charakteristisches Ambiente mit einer unverkennbar mit einer unverkennbar modernen Note zu schaffen.

FR. Différentes épaisseurs et profondeurs expriment notre envie d'oser et d'expérimenter. L'objectif est de recréer un espace dynamique, extrêmement distinctif, résolument contemporain.

ES. Varios espesores y profundidades identifican el deseo de audacia y experimentación. El objetivo es lograr un espacio dinámico, muy peculiar e indudablemente contemporáneo.

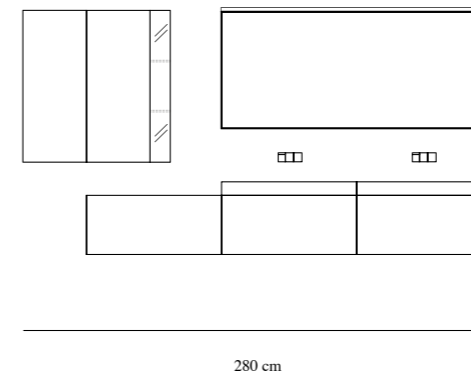

280 cm

IT. Dettaglio Pensile laterale a giorno in Cristallo Fumè con schienale Laccato Nero Opaco. **EN.** Detail of Fumè glass open side wall unit with matt Nero lacquered back panel. **DE.** Detail des seitlichen, offenen Oberschranks aus Kristallglas Fumè mit Rückwand in der lackierten Ausführung Nero matt. **FR.** Détail de l'armoire murale latérale ouverte en verre Fumè avec panneau arrière laqué Nero mat. **ES.** Detalle del mueble alto lateral abierto en cristal Fumè con trasera lacada Nero mate.

**Coordinazione e continuità
tra base e top. / The base unit and
top panel create a seamless visual
effect.**

IT. Dettaglio Piano con Doppio Lavabo integrato in Gres Marquinia Opaco. Spessore 8 cm. **EN.** Detail of 8 cm thick matt Gres Marquinia top with double integrated washbasin. **DE.** Detail der 8 cm starken Platte mit doppeltem integriertem Waschbecken aus Gres Marquinia matt. **FR.** Détail du plan de toilette avec double vasque intégrée en Gres Marquinia mat. Épaisseur 8 cm. **ES.** Detalle de la encimera con doble lavabo integrado de Gres Marquinia mate de 8 cm de espesor.



d.09



d.09

L 100 x P 50+L 100 x P 50 cm - Laccato Verde Bluastro soft touch

Composizione / Composition

IT. Estetiche che sanno valorizzare lo spazio, che svelano approcci originali sia nelle cromie, sia nell'identificazione di forme a contrasto.

EN. Our design solutions enhance the bathroom, revealing an original approach to colours, shapes and contrasts.

DE. Unsere Designlösungen werten das Badezimmerambiente auf und zeichnen sich durch originelle Farben, Formen und Kontraste aus.

FR. Nos solutions esthétiques mettent en valeur la salle de bains, en dévoilant une approche originale pour les couleurs, les formes et les contrastes.

ES. Soluciones estéticas que valorizan el espacio, que desvelan soluciones originales en las tonalidades y en la identificación de formas contrastantes.

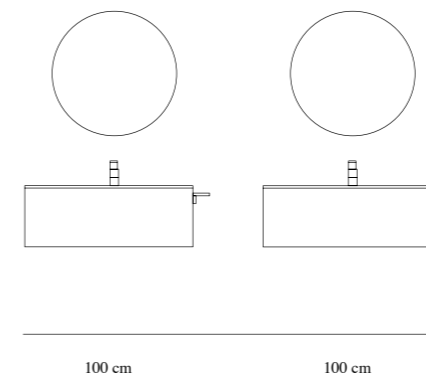

IT. Dettaglio Piano con Lavabo integrato Dogma in Cristalplant. Spessore 1,5 cm. **EN.** Detail of 1.5 cm thick Cristalplant Dogma top with integrated washbasin. **DE.** Detail der 1,5 cm starken Platte Dogma aus Cristalplant mit integriertem Waschbecken. **FR.** Détail du plan de toilette avec vasque intégrée Dogma en Cristalplant. Épaisseur 1,5 cm. **ES.** Detalle de la encimera con lavabo integrado Dogma de Cristalplant. Espesor 1,5 cm.

09.dettaglio/detail



IT. Dettaglio Specchiera Lap, diametro 80 cm. **EN.** Detail of 80 cm diameter Lap mirror. **DE.** Detail des Spiegels Lap, Durchmesser 80 cm. **FR.** Détail du miroir Lap, diamètre 80 cm. **ES.** Detalle del espejo Lap, diámetro 80 cm.



IT. Dettaglio su personalizzazione in riferimento al Lavabo Dogma. **EN.** Customization specification for the Dogma washbasin. **DE.** Detail der Personalisierung des Waschbeckens Dogma. **FR.** Détail de la personnalisation pour la vasque Dogma. **ES.** Detalle de la personalización del lavabo Dogma.

09.dettaglio/detail



IT. Un approfondito studio sulle tonalità, sui materiali, sui relativi abbinamenti. È Dogma.

EN. Thorough research into colours, materials and combinations: this is what the Dogma furnishing collection is about.

DE. Dogma zeichnet sich durch eine eingehende Recherche der Farbnuancen, Materialien und Kombinationen aus.

FR. Une étude approfondie sur les teintes, sur les matériaux et sur leurs combinaisons : voilà le secret de Dogma.

ES. Estudio exhaustivo de los colores, materiales y respectivas combinaciones. Es Dogma.

d.10

**Linguaggi in
continuo divenire.
/ Constantly
evolving styles.**





d.10

L 120 x P 50+L 40 x P 28 cm - Laccato Bianco opaco

Composizione / Composition

IT. Nuove prospettive, nuovi linguaggi, in continuo divenire, che ricollocano l'abitare contemporaneo. Volumi a contrasto e dettagli raffinati. Senza eccessi.

EN. Contrasting volumes and sophisticated details characterize modern bathrooms, creating new, constantly evolving perspectives and design elements that never look exaggerated.

DE. Kontrastierende Volumen und anspruchsvolle Details zeichnen moderne Bäder aus und schaffen neue, sich ständig weiterentwickelnde Perspektiven und Design-Elemente, die niemals übertrieben aussehen.

FR. Des volumes contrastants et des détails raffinés caractérisent ces salles de bains modernes, en créant de nouvelles perspectives en constante évolution et de nouveaux éléments de design qui ne sont jamais démesurés.

ES. Nuevas perspectivas y nuevos lenguajes en continua evolución que ofrecen una visión innovadora del vivir contemporáneo. Volúmenes en contraste y detalles refinados. Sin excesos.

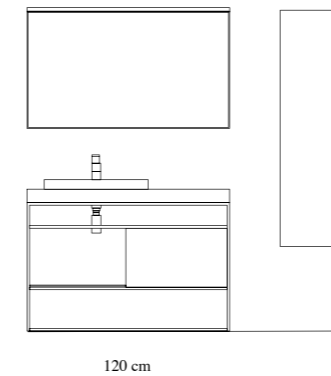

120 cm

IT. Dettaglio Lavabo Venere in Aquatek Bianco. **EN.** Detail of white Aquatek Venere washbasin. **DE.** Detail des Waschbeckens Venere aus Aquatek Bianco. **FR.** Détail de la vasque Venere en Aquatek Bianco. **ES.** Detalle del lavabo Venere de Aquatek Bianco.



10.dettaglio/detail



IT. ← Dettaglio Piano in Abete Vintage Naturale.
↑ Dettaglio doppio cassetto su base in Laccato Bianco Opaco. Il cassetto superiore è scomparsa.

EN. ← Detail of Abete Vintage Naturale top. ↑ Detail of matt Bianco lacquered base unit with 1 deep drawer and 1 top concealed drawer.

DE. ← Detail der Platte aus Abete Vintage Naturale.
↑ Detail der doppelten Schublade auf Unterschrank in der lackierten Ausführung Bianco matt. Die obere Schublade ist verdeckt.

FR. ← Détail du plan de toilette en Abete Vintage Naturale. ↑ Détail du double tiroir sur base en laqué Bianco mat. Le tiroir supérieur est intégré.

ES. ← Detalle de la encimera de Abete Vintage Naturale. ↑ Detalle del doble cajón sobre base en acabado lacado Bianco mate. El cajón superior es escamoteable.

d.11

**Nuove prospettive
per l'ambiente
bagno. / New
perspectives
for the bathroom.**





d.11

L 120 x P 50+L 52 x P 28 cm - Rovere Laccato Bianco opaco poro aperto

Composizione / Composition

IT. Ogni composizione rivela concetti legati alla sperimentazione ed alla ricerca. La stanza da bagno vive di nuove prospettive. Tra eleganza e contemporaneità.

EN. Each and every furnishing combination reveals our commitment to research and experimentation. The bathroom offers new perspectives in terms of elegance and modern style.

DE. Jede Komposition zeugt von Experimentierfreude und Forschung. Das Badezimmerambiente bietet neue Perspektiven hinsichtlich Eleganz und Modernität.

FR. Chaque composition révèle nos envies d'expérimentation et de recherche. La salle de bains offre de nouvelles perspectives en termes d'élégance et style contemporain.

ES. Cada composición desvela conceptos vinculados con la experimentación y la investigación. El cuarto de baño que vive de nuevas perspectivas. Entre elegancia y contemporaneidad.

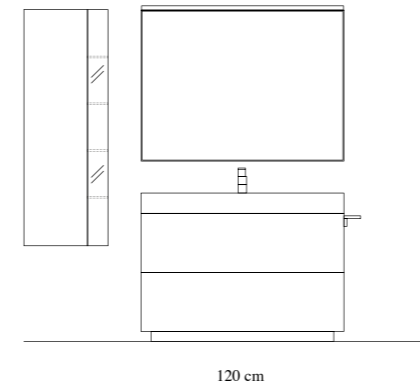

IT. Dettaglio Piano con Lavabo integrato Dogma in Cristalplant, spessore 12 cm. Portasciugamano con struttura in alluminio verniciata in finitura Bianco. **EN.** Detail of 12 cm thick Cristalplant Dogma top with integrated washbasin. Towel rail with Bianco painted aluminium frame. **DE.** Detail der 12 cm starken Platte Dogma aus Cristalplant mit integriertem Waschbecken. Detail des Handtuchhalters mit lackierter Aluminiumstruktur in der Ausführung Bianco. **FR.** Détail du plan de toilette avec vasque intégrée Dogma en Cristalplant, épaisseur 12 cm. Porte-serviettes avec structure en aluminium peinte dans la finition Bianco. **ES.** Detalle de la encimera con lavabo integrado Dogma de Cristalplant, de 12 cm de espesor. Toallero con estructura de aluminio pintada en acabado Bianco.

11.dettaglio/detail



IT. Il Bianco domina la scena. Il Cristallo Fumè diventa elemento di rottura e di spicco.

EN. White is the prevailing colour, while Fumè glass adds rhythm to this marvellous furnishing solution.

DE. Weiß dominiert die Szene, während das Kristallglas Fumè dem Ambiente eine dynamische Note verleiht.

FR. Le blanc domine la scène. Le verre Fumè devient l'élément de contraste et de distinction.

ES. El blanco domina la escena. El cristal Fumè es el elemento destacado más exclusivo.

11.dettaglio/detail



IT. ↑ Vista Zenitale Lavabo integrato Dogma in Cristalplant. → Dettaglio Colonna Laterale a giorno in Cristallo Fumè con schienale in Rovere Laccato Bianco poro aperto.

EN. ↑ Top view of Cristalplant Dogma integrated washbasin. → Detail of Fumè glass open side wall unit with open-pore Bianco lacquered Rovere back panel.

DE. ↑ Draufsicht auf das integrierte Waschbecken Dogma aus Cristalplant. → Detail des offenen Hochschrankes aus Kristallglas Fumè mit Rückwand in der Ausführung Rovere Bianco offenporig lackiert.

FR. ↑ Vue de haut de la vasque intégrée Dogma en Cristalplant. → Détail de la colonne latérale ouverte en verre Fumè avec panneau arrière en Rovere laqué Bianco à pore ouvert.

ES. ↑ Vista desde arriba del lavabo integrado Dogma de Cristalplant. → Detalle de la columna lateral abierta en cristal Fumè con trasera de Rovere lacado Bianco de poro abierto.





d.12



d.12

L 220 x P 50/18 cm - Laccato Verde Canna soft touch

Composizione / Composition

IT. Anche la stanza da bagno esprime una forte personalità. Si intrecciano ispirazioni di natura contemporanea con richiami alla tradizione dettati dall'impiego di materiali vissuti e densi di significati.

EN. Modern bathrooms express a strong personality too: drawing their inspiration from modern design, they use traditional materials with strong evocative power.

DE. Moderne Badezimmer zeichnen sich durch eine starke Persönlichkeit aus. Sie lassen sich vom modernen Design inspirieren und verwenden traditionelle Materialien mit einer starken Ausdruckskraft.

FR. Les salles de bains expriment leur forte personnalité aussi : tirant leur inspiration du design moderne, elles utilisent des matériaux traditionnels empreints de significations.

ES. También el cuarto de baño manifiesta una fuerte personalidad. Se mezclan inspiraciones contemporáneas con evocaciones tradicionales que se concretizan en el uso de materiales de aspecto usado y densos de significado.

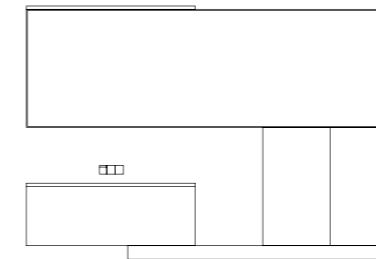

220 cm

IT. Dettaglio Piano da appoggio in Abete Vintage Sbiancato. Pensili laccato Verde Canna Soft Touch, profondità 18cm. **EN.** Detail of Abete Vintage Sbiancato shelf. 18 cm thick soft touch Verde Canna lacquered wall units. **DE.** Detail der Ablageplatte aus Abete Vintage Sbiancato. 18 cm tiefe Oberschränke in der lackierten Ausführung Verde Canna Soft Touch. **FR.** Détail du plan d'appui en Abete Vintage Sbiancato. Armoires murales en laqué Verde Canna Soft Touch, profondeur 18 cm. **ES.** Detalle de la encimera de apoyo en Abete Vintage Sbiancato. Muebles altos lacados verde Canna Soft Touch, de 18 cm de profundidad.

12.dettaglio/detail



IT. Vista zenitale della composizione dove spiccano le diverse profondità dei diversi volumi.

EN. Top view of furnishing combination with varying depths and volumes.

DE. Draufsicht auf die Kombination mit unterschiedlich tiefen Volumen.

FR. Vue de haut de la composition caractérisée par les différentes profondeurs des différents volumes.

ES. Vista desde arriba de la composición donde se destacan las distintas profundidades y volúmenes.



d.13

**Piacevoli sensazioni
abitative.
/ A pleasant home
environment.**



IT. Dettaglio cassetto aperto accessoriatato con divisori su Base in Laccato Bianco Soft Touch. **EN.** Detail of open drawer with internal accessories. Soft Touch Bianco lacquered base unit. **DE.** Detail offene Schublade mit internen Trennwänden auf Unterschrank in der lackierten Ausführung Bianco Soft Touch. **FR.** Détail du tiroir ouvert équipé de séparateurs sur base en laqué Bianco Soft Touch. **ES.** Detalle del cajón abierto con divisorios internos sobre mueble bajo en lacado Bianco Soft Touch.

d.13

L 180 x P 50 cm - Laccato Bianco opaco

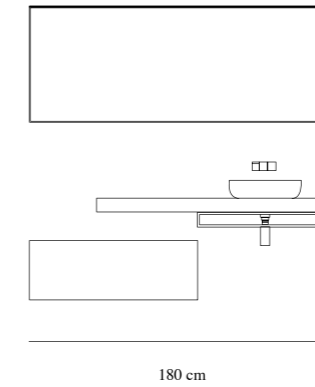

Composizione / Composition

IT. Atmosfere ricercate, suggestive, dall'animo profondamente elegante. In questo contesto si riscoprono tonalità neutre, desature, perfettamente allineate al concetto di piacevole sensazione abitativa.

EN. We like to create sophisticated atmospheres where glamorous elegance is the key. We have rediscovered pale, neutral shades that are perfectly in line with our concept of comfortable living.

DE. Wir möchten eine suggestive Atmosphäre schaffen, die sich durch eine glamouröse Eleganz auszeichnet. Wir haben blasser, neutrale Farben wiederentdeckt, die in perfektem Einklang mit unserer Vorstellung von Wohnkomfort stehen.

FR. Nous aimons créer des atmosphères sophistiquées et suggestives, dont la clé est l'élégance. Nous avons redécouvert les tonalités pâles, neutres, qui sont parfaitement en ligne avec notre concept de bien-être de l'habitation.

ES. Ambientaciones refinadas y sugestivas, impregnadas de una actitud profundamente elegante. En este contexto se descubren tonalidades neutras y desaturadas, que se alinean perfectamente con el concepto de sensación agradable del habitar.

13.dettaglio/detail



IT. ↑ Dettaglio zenitale Lavabo Seed con diametro 45 cm. → Un Design che, abbinato ai materiali, racconta soluzioni abitative articolate dal punto di vista tecnico e progettuale. **EN.** ↑ Top view of 45 cm diameter Seed washbasin. → This design solution uses different materials to create technically advanced environments. **DE.** ↑ Draufsicht auf das Waschbecken Seed mit Durchmesser 45 cm. → Diese Design-Lösung setzt verschiedene Materialien ein, um ein technisch hochentwickeltes Ambiente zu schaffen. **FR.** ↑ Vue de haut de la vasque Seed de diamètre 45 cm. → Cette solution de design utilise plusieurs matériaux pour créer des environnements techniquement avancés. **ES.** ↑ Vista desde arriba del lavabo Seed de 45 cm de diámetro. → Diseño y materiales que narran de soluciones articuladas para la habitación desde el punto de vista técnico y de proyecto.



Essenze / Woods / Holzarten / Finitions / Maderas



Rovere Termocotto



Rovere Naturale

Gres opachi / matt stoneware / gres matt / gres mats / gres opacos



Calacatta Oro Venato



Statuario



Nero Marquinia



Diamond Cream



Pietra Grey

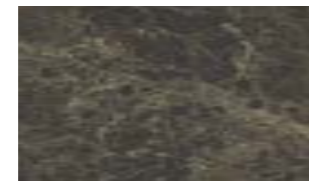

Emperador Extra

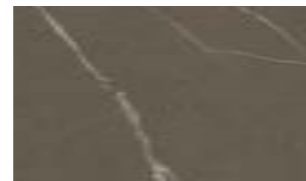

Pietra Piasentina Taupe (opaco o fiammato / matt or flamed)

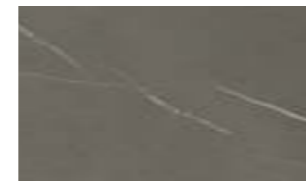

Pietra Piasentina Grigio (opaco o fiammato / matt or flamed)



Invisible White (soft)



Bianco Assoluto



Nero Assoluto

Gres lucidi / glossy stoneware / gres glänzenden / gres brillants / gres brillos



Calacatta Oro Venato



Statuario

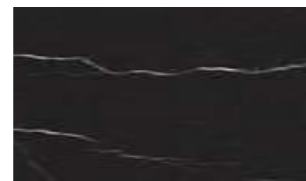

Nero Marquinia



Diamond Cream



Pietra Grey



Emperador Extra

Per le finiture frontali in gres, fare riferimento alla scatola campioni "i gres di laminam" / for more information on our range of finishes for the stoneware fronts please refer to the stoneware swatch box "i gres di laminam" / weitere informationen über unser angebot an oberflächen für steinzeugfronten können sie der steinzeug-musterbox "i gres di laminam" entnehmen / pour plus d'informations sur notre gamme de finitions pour les façades en grès, veuillez vous référer à la boîte d'échantillons "i gres di laminam" / para los acabados frontales de gres, remitirse a la caja de muestras "i gres di laminam".

Laccati metal color opachi su finitura liscia e laccati metal color opachi su finitura rovere a poro aperto / smooth-finish matt metal lacquers and open-pore rovere with a matt metal lacquered finish / glatter matte lackausführungen metal und matte lackausführungen metal auf offenporiger rovere-ausführung / laqués metal mats sur finition lisse et laqués metal mats sur finition rovere à pore ouvert / lacados metal mate en acabado liso y lacados metal mate en acabado roble de poro abierto.



Oro



Rame



Titanio



Bianco Perlato

Laccati opachi e soft touch su finitura liscia e laccati opachi su finitura rovere a poro aperto / smooth-finish matt and soft touch lacquers; open-pore rovere with a matt lacquered finish / matte lackfarben soft touch auf glatter ausführung und matte lackfarben auf offenporiger rovere-ausführung / laqués mats et soft touch sur finition lisse; laqués mats sur finition rovere à pore ouvert / lacados mate y soft touch en acabado liso y lacados mate en acabado roble de poro abierto.



Bianco



Perla



Sahara



Beige Avorio



Senape



Malto



Giallo Bikini



Biscotto



Cappuccino



Tortora



Marrone Terra



Verde Salvia



Verde Canna



Verde Bluastro



Blu Acciaio



Petrolio



Azzurro India



Verde Marino



Blu Pastello



Cobalto



Curacao



Rosso Arancio



Rosso Giamaica



Rossetto



Rosso Cuoio



Rosso Scuro



Grigio Viola



Orchidea



Diva



Confetto

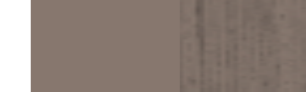

Noce Moscata



Medioevo



Grigio Cenere



Grigio Seta

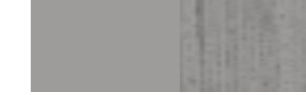

Grigio Nuvola



Polvere

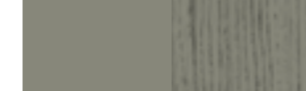

Grigio Pietra



Grigio Londra



Grigio Traffico



Marrone Grigio (No Soft Touch)

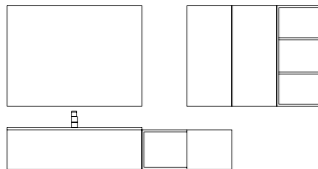

Nero (No Soft Touch)

d.01	Pag. 008-013	Composizione	L 280 x P 50/18 cm
		Basi	L 120+80 x H 35 x P 50 cm
		Pensile	L 40+40 x H 90 x P 18 cm
		Pensile a giorno	L 40 x H 90 x P 17 cm
		Piano con lavabo integrato "Dogma"	L 120 x P 50 x SP 1,5 cm
		Specchiera "Side"	L 120 x H 90 cm

Base and wall units with Rovere Naturale carcass and matt Gres Statuario fronts; Rovere Naturale open wall unit, Cristalplant Dogma top with integrated washbasin, Side mirror. / Unter- und Oberschränke mit Korpus aus Rovere Naturale und Fronten aus Gres Statuario matt, offener Oberschrank aus Rovere Naturale, Platte Dogma aus Cristalplant mit integriertem Waschbecken, Spiegel Side. / Bases et armoires murales avec structure en Rovere Naturale et façades en Gres Statuario mat; armoire murale ouverte en Rovere Naturale, plan de toilette Dogma en Cristalplant avec vasque intégrée, miroir Side. / Muebles bajos y altos con carcasa en Rovere Naturale y parte frontal en Gres Statuario mate, mueble alto sin puertas en Rovere Naturale, encimera Dogma en Cristalplant con lavabo integrado, espejo Side.

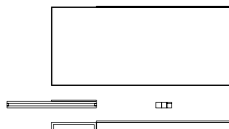
d.02	Pag. 014-021	Composizione	L 160 x P 50 cm
		Basi	L 40+120 x H 35 x P 50 cm
		Piano con lavabo integrato "Dogma"	L 120 x P 50 cm x SP 1,5 cm
		Specchiera "Frame"	L 160 x H 70 cm
		Lampada "Minimal"	L 120 cm

Rovere Termocotto base units, Cristalplant Dogma top with integrated washbasin, Rovere Termocotto Frame mirror with Minimal lamp. / Unterschränke aus Rovere Termocotto, Platte Dogma aus Cristalplant mit integriertem Waschbecken, Spiegel Frame aus Rovere Termocotto mit Lampe Minimal. / Bases en Rovere Termocotto, plan de toilette Dogma en Cristalplant avec vasque intégrée, miroir Frame en Rovere Termocotto avec lampe Minimal. / Muebles bajos en Rovere Termocotto, encimera Dogma en Cristalplant con lavabo integrado, espejo Frame en Rovere Termocotto con lámpara Minimal.

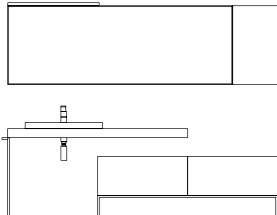
d.03	Pag. 022-027	Composizione	L 240 x P 50/18 cm
		Basi	L 80+80 x H 35 x P 50 cm
		Struttura in alluminio	L 160 x H 24 x P 50 cm
		Pensile	L 40 x H 70 x P 18 cm
		Piano	L 160 x H 8 x P 50 cm
		Specchiera "Frame"	L 200 x H 70 cm
		Lavabo semincasso "Slide"	L 70 x P 50 x SP 5 cm
		Lampada "Minimal"	L 80 cm

Matt Bianco lacquered base units, Carbone-finish aluminium frame, matt Bianco wall unit, Abete Vintage Sbiancato top, Carbone-finish Frame mirror with Minimal lamp, Slide semi-inset washbasin. / Unterschränke Bianco matt lackiert, Struktur aus Aluminium Ausführung Carbone, Oberschrank Bianco matt lackiert, Platte aus Abete Vintage Sbiancato, Spiegel Frame in der Ausführung Carbone mit Lampe Minimal, Halbeinbauwaschbecken Slide. / Bases en laqué Bianco mat, structure en aluminium finition Carbone, armoire murale en laqué Bianco mat, plan de toilette en Abete Vintage Sbiancato, miroir Frame finition Carbone avec lampe Minimal, vasque semi-encastree Slide. / Muebles bajos en lacado Bianco mate, estructura de aluminio acabado Carbone, mueble alto lacado Bianco mate, encimera en Abete Vintage Sbiancato, espejo Frame en acabado Carbone con lámpara Minimal, Lavabo semiempotrado Slide.

d.04	Pag. 028-035	Composizione	L 280 x P 50 cm
		Basi	L 100+40+100+40 x H 35 x P 50 cm
		Specchiera "Side"	L 135+135 x H 35+ L 135+135 x H 70 cm
		Lavabo "Slide"	L 70 x P 35 x SP 13,5 cm

Rovere Termocotto base units, Side mirror, matt Marmo Carrara Slide washbasin. / Unterschränke aus Rovere Termocotto, Spiegel Side, Waschbecken Slide aus Marmo Carrara matt. / Bases en Rovere Termocotto, miroir Side, vasque Slide en Marmo Carrara mat. / Muebles bajos en Rovere Termocotto, espejo Side, lavabo Slide en Marmo Carrara mate.

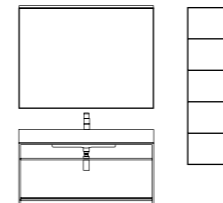
d.05	Pag. 036-041	Composizione	L 120 x P 50+L 40 x P 28 cm
		Struttura in alluminio	L 120 x H 76 x P 50 cm
		Colonna a giorno	L 40 x H 140 x P 28 cm
		Piano con lavabo integrato "Dogma"	L 120 x P 50 x SP 12 cm
		Specchiera "Frame"	L 120 x H 90
		Lampada "Minimal"	L 120 cm

Carbone-finish aluminium frame with matt, open-pore Bianco lacquered Rovere shelf, Cristallo Fumè open tall unit with matt, open-pore Bianco lacquered Rovere back panel, Cristalplant Dogma top with integrated washbasin, Carbone-finish Frame mirror with Minimal lamp. / Struktur aus Aluminium Ausführung Carbone mit Fachboden aus Rovere Bianco matt lackiert offenporig, offener Hochschrank Cristallo Fumè mit Rückwand aus Rovere Bianco matt lackiert offenporig, Platte Dogma aus Cristalplant mit integriertem Waschbecken, Spiegel Frame in der Ausführung Carbone mit Lampe Minimal. / Structure en aluminium finition Carbone avec étagère en Rovere laqué Bianco mat à pore ouvert, colonne ouverte Cristallo Fumè avec panneau arrière en Rovere laqué Bianco mat à pore ouvert, plan de toilette Dogma en Cristalplant avec vasque intégrée, miroir Frame finition Carbone avec lampe Minimal. / Estructura de aluminio acabado Carbone con estante en Rovere lacado Bianco mate de poro abierto, columna sin puertas Cristallo Fumè con trasera en Rovere lacado Bianco mate de poro abierto, encimera Dogma en Cristalplant con lavabo integrado, espejo Frame en acabado Carbone con lámpara Minimal.

d.06	Pag. 044-049	Composizione	L 160 x P 50/36 cm
		Basi	L 80 x H 35 x P 50 + L 80 x H 35 x P 36 cm
		Piano con lavabo integrato	L 120 x H 14 x P 50 cm
		Specchiera "Frame"	L 160 x H 70 cm
		Lampada "Minimal"	L 80 cm

Rovere Termocotto base units, matt Gres Statuario top with integrated washbasin, Rovere Termocotto Frame mirror with Minimal lamp. / Unterschränke aus Rovere Termocotto, Platte mit integriertem Waschbecken aus Gres Statuario Matt, Spiegel Frame aus Rovere Termocotto mit Lampe Minimal. / Bases en Rovere Termocotto, plan de toilette avec vasque intégrée en Gres Statuario mat, miroir Frame en Rovere Termocotto avec lampe Minimal. / Muebles bajos en Rovere Termocotto, encimera con lavabo integrado en Gres Statuario mate, espejo Frame en Rovere Termocotto con lámpara Minimal.

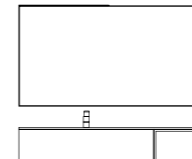
d.07	Pag. 050-055	Composizione	L 160 x P 50 cm
		Basi	L 120+40 x H 70 x P 50 cm
		Struttura in alluminio	L 160 x H 16 x P 50 cm
		Piano con lavabo integrato	L 160 x P 50 x SP 1,2 cm
		Specchiera "Frame"	L 160 x H 90 cm
		Lampada "Minimal"	L 80 cm

Rovere Naturale base units, Bianco frame, Bianco Aquatek top with integrated washbasin, Bianco-finish Frame mirror with Minimal lamp. / Unterschränke aus Rovere Naturale, Rahmen Bianco, Platte mit integriertem Waschbecken Aquatek Bianco, Spiegel Frame in der Ausführung Bianco mit Lampe Minimal. / Bases en Rovere Naturale, cadre Bianco, plan de toilette avec vasque intégrée Aquatek Bianco, miroir Frame finition Bianco avec lampe Minimal. / Muebles bajos en Rovere Naturale, bastidor Bianco, encimera con lavabo integrado Aquatek Bianco, espejo Frame en acabado Bianco con lámpara Minimal.

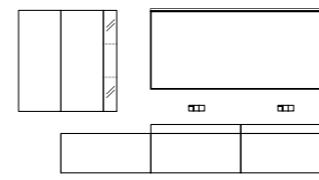
d.08	Pag. 056-061	Composizione	L 280 x P 50/36/18 cm
		Basi	L 80 x H 35 x P 36 + L 80+80 x H 35 x P 50 cm
		Pensili	L 40+40 x H 90 x P 18 cm
		Pensile laterale a giorno	L 12 x H 90 x P 18 cm
		Piano con lavabi integriati	L 160 x P 50 x SP 8 cm
		Specchiera "Frame"	L 160 x H 70 cm
		Lampada "Minimal"	L 160 cm

Base units with matt Nero lacquered carcass and matt Gres Marquinia fronts, matt Nero lacquered wall units, Cristallo Fumè open side wall unit with matt Nero lacquered back panel, matt Gres Marquinia top with integrated washbasins, Carbone-finish Frame mirror with Minimal lamp. / Unterschränke mit Korpus Nero matt lackiert und Fronten Gres Marquinia matt, Oberschränke Nero matt lackiert, seitlicher, offener Oberschrank Cristallo Fumè mit Rückwand Nero matt lackiert, Platte mit integrierten Waschbecken aus Gres Marquinia matt, Spiegel Frame in der Ausführung Carbone mit Lampe Minimal. / Bases avec structure en laqué Nero mat et façades Gres Marquinia mat, armoires murales en laqué Nero mat, armoire murale latérale ouverte Cristallo Fumè avec panneau arrière en laqué Nero mat, plan de toilette avec vasques intégrées en Gres Marquinia mat, miroir Frame finition Carbone avec lampe Minimal. / Muebles bajos con carcasa lacado Nero mate y parte frontal Gres Marquinia mate, muebles altos lacado Nero mate, mueble alto sin puertas Cristallo Fumè con trasera en lacado Nero mate, encimera con lavabos integrados en Gres Marquinia mate, espejo Frame en acabado Carbone con lámpara Minimal.

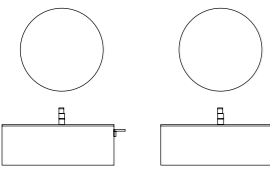
d.09	Pag. 062-069	Composizione	L 100 x P 50+L 100 x P 50 cm	
		Base	L 100 x H 35 x P 50 cm	Laccato Verde Bluastro soft touch
		Specchiera "Lap"	Ø 8 c m	- - -
		Piano con lavabo integrato "Dogma"	L 100 x P 50 x SP 1,5 cm	Cristalplant
Soft touch Verde Bluastro lacquered base unit, Lap mirror, Cristalplant Dogma top with integrated washbasin. / Unterschrank aus Verde Bluastro Soft Touch lackiert, Spiegel Lap, Platte Dogma aus Cristalplant mit integriertem Waschbecken. / Base en laqué Verde Bluastro soft touch, miroir Lap, plan de toilette Dogma en Cristalplant avec vasque intégrée. / Mueble bajo en lacado Verde Bluastro soft touch, espejo Lap, encimera Dogma en Cristalplant con lavabo integrado.				

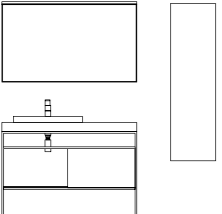
d.10	Pag. 070-075	Composizione	L 120 x P 50+L 40 x P 28 cm	
		Base	L 60 x H 35 x P 50 cm	Laccato Bianco opaco
		Struttura in alluminio	L 120 x H 76 x P 50 cm	Carbone
		Colonna	L 40 x H 140 x P 28 cm	Laccato Bianco opaco
		Piano	L 120 x P 50 x SP 8 cm	Abete Vintage Naturale
		Specchiera "Frame"	L 120 x H 70 cm	Carbone
		Lavabo "Venere"	- - -	Aquatek Bianco
		Lampada "Minimal"	L 120 cm	- - -
Matt Bianco lacquered base unit, Carbone-finish frame, matt Bianco lacquered tall unit, Abete Vintage Naturale top, Carbone-finish Frame mirror with Minimal lamp, Bianco Aquatek Venere washbasin. / Unterschrank Bianco matt lackiert, Rahmen in der Ausführung Carbone, Colonna Bianco matt lackiert, Platte aus Abete Vintage Naturale, Spiegel Frame in der Ausführung Carbone mit Lampe Minimal, Waschbecken Venere aus Aquatek Bianco. / Base en laqué Bianco mat, cadre finition Carbone, colonne en laqué Bianco mat, plan de toilette en Abete Vintage Naturale, miroir Frame finition Carbone avec lampe Minimal, vasque Venere en Aquatek Bianco. / Mueble bajo lacado Bianco mate, bastidor en acabado Carbone, columna en lacado Bianco mate, encimera en Abete Vintage Naturale, espejo Frame en acabado Carbone con lámpara Minimal, lavabo Venere en Aquatek Bianco.				

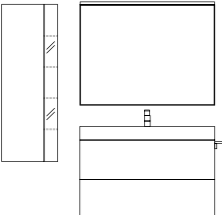
d.11	Pag. 076-083	Composizione	L 120 x P 50+L 52 x P 28 cm	
		Base	L 120 x H 70+6 x P 50 cm	Rovere Laccato Bianco opaco poro aperto
		Colonna	L 40 x H 140 x P 28 cm	Rovere Laccato Bianco opaco poro aperto
		Colonna laterale a giorno	L 12 x H 90 x P 18 cm	Cristallo Fumè con schienale Rovere Laccato Bianco opaco poro aperto
		Piano con lavabo integrato "Dogma"	L 120 x P 50 x SP 12 cm	Cristalplant
		Specchiera "Frame"	L 120 x H 90 cm	Bianco
		Lampada "Minimal"	L 120 cm	- - -
Matt, open-pore Bianco lacquered Rovere base and tall unit, Cristallo Fumè open side tall unit with matt, open-pore Bianco lacquered Rovere back panel, Cristalplant Dogma top with integrated washbasin, Bianco-finish Frame mirror with Minimal lamp. / Unterschrank und Hochschrank aus Rovere Bianco matt lackiert offenporig, seitlicher, offener Hochschrank Cristallo Fumè mit Rückwand Rovere Bianco matt lackiert offenporig, Platte Dogma aus Cristalplant mit integriertem Waschbecken, Spiegel Frame in der Ausführung Bianco mit Lampe Minimal. / Base et colonne en Rovere laqué Bianco mat à pore ouvert, colonne latérale ouverte Cristallo Fumè avec panneau arrière en Rovere laqué Bianco mat à pore ouvert, plan de toilette Dogma en Cristalplant avec vasque intégrée, miroir Frame finition Bianco avec lampe Minimal. / Mueble bajo y columna en Rovere lacado Bianco mate de poro abierto, columna lateral sin puertas Cristallo Fumè con trasera Rovere lacado Bianco mate de poro abierto, encimera Dogma en Cristalplant con lavabo integrado. Espejo Frame en acabado Bianco con lámpara Minimal.				

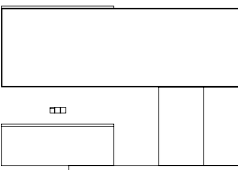
d.12	Pag. 084-089	Composizione	L 220 x P 50/18 cm	
		Base	L 100 x H 35 x P 50 cm	Laccato Verde Canna soft touch
		Pensili	L 40+40 x H 70 x P 18 cm	Laccato Verde Canna soft touch
		Piano	L 160 x P 50 x SP 8 cm	Abete Vintage Sbiancato
		Piano con lavabo integrato	L 100 x P 50 cm	Cristallo Laccato Verde Canna Sabbiato
		Specchiera "Frame"	L 220 x H 70 cm	Bianco
		Lampada "Minimal"	L 120 cm	- - -
Soft touch Verde Canna lacquered base and wall units, Abete Vintage Sbiancato top, brushed Verde Canna lacquered glass top with integrated washbasin, Bianco-finish Frame mirror with Minimal lamp. / Unterschrank und Oberschränke Verde Canna Soft Touch lackiert, Platte aus Abete Vintage Sbiancato, Platte mit integriertem Waschbecken Cristallo Verde Canna Sabbiato lackiert, Spiegel Frame in der Ausführung Bianco mit Lampe Minimal. / Base et armoires murales en laqué Verde Canna soft touch, plan de toilette en Abete Vintage Sbiancato, plan de toilette avec vasque intégrée Cristallo en laqué Verde Canna sablé, miroir Frame finition Bianco avec lampe Minimal. / Muebles bajos y altos lacados Verde Canna soft touch, encimera en Abete Vintage Sbiancato, encimera con lavabo integrado Cristallo lacado Verde Canna deslustrado, espejo Frame en acabado Bianco con lámpara Minimal.				

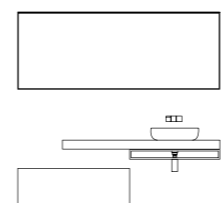
d.13	Pag. 090-095	Composizione	L 180 x P 50 cm	
		Base	L 100 x H 35 x P 50 cm	Laccato Bianco opaco
		Piano	L 140 x P 50 x SP 8 cm	Abete Vintage Naturale
		Specchiera "Frame"	L 180 x H 70 cm	Bianco
		Lavabo "Seed"	Ø 45 cm	Ceramica
		Lampada "Minimal"	L 180 cm	- - -
Matt Bianco lacquered base unit, Abete Vintage Naturale top, Bianco-finish Frame mirror with Minimal lamp, Ceramic Seed washbasin. / Unterschrank Bianco matt lackiert, Platte aus Abete Vintage Naturale, Spiegel Frame in der Ausführung Bianco mit Lampe Minimal, Waschbecken Seed aus Keramik. / Base en laqué Bianco mat, plan de toilette en Abete Vintage Naturale, miroir Frame finition Bianco avec lampe Minimal, vasque Seed en céramique. / Mueble bajo lacado Bianco mate, encimera en Abete Vintage Naturale, espejo Frame en acabado Bianco con lámpara Minimal, lavabo Seed en cerámica.				

ITALIAN DESIGN

Ogni "prodotto" IDEAGROUP viene realizzato in Italia ma ciò che lo rende un esempio di Made in Italy per eccellenza (al 100%) sono i suoi valori: la creatività, la tradizione nel mondo del mobile che risale al 1987 e la qualità, caratteristica naturale per un'azienda che si confronta giornalmente con il proprio pubblico e le sue esigenze. Tutto ciò si traduce in un'esperienza e in un know-how specifici.

All IDEAGROUP "products" are manufactured in Italy. Their unique values turn them into excellent examples of 100% Italian style: creativity, a long cabinetmaking tradition since 1987 and quality, which is a natural characteristic of a company that caters for its customers' needs on a daily basis. All of this translates into specific experience and know-how.

Jedes "Produkt" von IDEAGROUP wird in Italien angefertigt, aber es sind seine Werte, die es zu einem gelungenen Beispiel des "Made in Italy" (zu 100%) machen: die Kreativität, die Tradition in der Möbelwelt, die auf das Jahr 1987 zurückgeht, und die Qualität, eine natürliche Eigenschaft für einen Betrieb, der sich täglich mit den Kunden und deren Bedürfnissen auseinandersetzt. All das zeugt von einer eingehenden Erfahrung und einem spezifischen Know-how.

Chaque «produit» IDEAGROUP est réalisé en Italie, mais plus que cela, ce qui en fait un excellent exemple de style 100% Made in Italy ce sont ses valeurs: la créativité, la tradition comme producteur de meubles depuis 1987 et la qualité, caractéristique naturelle pour une entreprise qui se mesure quotidiennement avec son public et ses exigences. Tout cela se traduit dans une expérience et dans un savoir-faire spécifiques.

Cada "producto" IDEAGROUP viene fabricado en Italia, pero lo que la convierte en un ejemplo de Made in Italy por excelencia (al 100%) son sus valores: la creatividad, la tradición en el mundo del mueble que nos remonta al 1987 y la calidad, característica natural de una empresa que se confronta diariamente con el propio público y sus exigencias. Todo ello se traduce en una experiencia y en un know-how específico.

EUROPEAN MATERIALS

I materiali che compongono i nostri prodotti provengono esclusivamente dal Mercato Comune Europeo.

Our products are made exclusively with materials sourced in the European Union.

Die Materialien, mit denen unsere Produkte angefertigt wurden, stammen ausschließlich aus dem Europäischen Binnenmarkt.

Les matériaux qui composent nos produits proviennent exclusivement de l'Union Européenne.

Los materiales que componen nuestros productos provienen exclusivamente del Mercado Común Europeo.



È un pannello di tipo truciolare nel quale viene impiegato solo legno riciclato, con materiali ecocompatibili. È dotato di notevole solidità, compattezza, indeformabilità e resistenza.

This is a type of particleboard panel which is made of recycled wood and environment-friendly materials. It is remarkably solid, does not deform, and is durable.

Es handelt sich um eine Spanplatte, für deren Anfertigung ausschließlich recyceltes Holz, d.h. umweltfreundliche Materialien, verwendet wird. Sie ist besonders stabil, kompakt, unverformbar und widerstandsfähig.

C'est un panneau de particules de bois dans lequel est utilisé uniquement du bois recyclé, avec des matériaux écocompatibles. Il est caractérisé par une remarquable solidité, compacité, indéformabilité et résistance.

Es un panel de tipo aglomerado en el que se emplea únicamente madera reciclada, con materiales ecocompatibles. Indeformable y compacto, dotado de una notable solidez y resistencia.



Idropan garantisce la migliore difesa all'umidità alla quale il mobile può essere accidentalmente esposto. Una sicurezza in più per proteggere un mobile di qualità.

Idropan provides for better resistance in case of accidental exposure to humidity. Added protection for your top-quality furniture.

Idropan gewährleistet den besten Schutz vor der Feuchtigkeit, der ein Möbel aus Versehen ausgesetzt werden kann. Eine zusätzliche Sicherheit, um qualitativ hochwertige Möbel zu schützen.

Idropan garantit la meilleure défense contre l'humidité à laquelle le meuble peut être accidentellement exposé. Une sécurité en plus pour protéger un meuble de qualité.

Hidropan garantiza la mejor defensa a la humedad a la que el mueble puede estar sometido accidentalmente. Mayor seguridad para proteger un mueble de calidad.

Mdf

MDF: sigla di Medium Density Fiberboard, ovvero "pannello a media densità". Dalle ottime caratteristiche meccaniche, molto stabile e compatto, questo pannello è in grado di offrire una buona resistenza all'umidità, con minima emissione di formaldeide.

Abbreviation for Medium Density Fibreboard. It offers exceptional mechanical characteristics and is very stable and solid. This panel offers excellent resistance to moisture, with minimal emissions of formaldehyde.

MDF: Abkürzung für Medium Density Fiberboard, d.h. "mitteldichte Holzfaserverplatte". Diese Platte, die hervorragende mechanische Eigenschaften aufweist und sehr stabil und kompakt ist, ist besonders wasserfest und zeichnet sich durch minimale Formaldehydemissionen aus.

MDF: abréviation de Medium Density Fiberboard, à savoir «panneau de fibres à densité moyenne». Il présente des caractéristiques mécaniques optimales et est très stable et solide. Le panneau est en mesure d'offrir une bonne résistance contre l'humidité, avec une émission minimale de formaldéhyde.

MDF: sigla de Medium Density Fiberboard, ó bien "panel a media densidad". De óptimas características mecánicas, muy estable y compacto, este panel está en grado de ofrecer una buena resistencia a la humedad, con mínima emisión de formaldehído.



CATAS è il punto di riferimento in Italia per le prove di laboratorio in questo settore e certifica il prodotto in base alle normative tecniche italiane, europee e internazionali per quanto riguarda la resistenza meccanica, le prove reazione fuoco, la sicurezza arredamento, l'emissione formaldeide, l'analisi difetti legno e molto altro ancora.

CATAS is a reference research centre and laboratory for furniture companies in Italy, which certifies products according to Italian, European and international technical regulations with reference to mechanical resistance, fire reaction, safety, formaldehyde emissions, wood defect analyses and much more.

CATAS ist der Bezugspunkt in Italien für die Laborprüfungen in diesem Sektor und zertifiziert das Produkt auf der Grundlage der italienischen, europäischen und internationalen technischen Vorschriften im Zusammenhang mit der mechanischen Festigkeit, der Prüfungen der Feuerbeständigkeit, der Sicherheit, der Formaldehydemission, der Analyse von Holzdefekten usw.

CATAS est le centre de recherche et laboratoire de référence en Italie pour l'industrie du meuble, qui certifie le produit conformément aux réglementations techniques italiennes, européennes et internationales en ce qui concerne la résistance mécanique, les essais de réaction au feu, la sécurité des meubles, l'émission de formaldéhyde, l'analyse des défauts du bois et beaucoup plus encore.

CATAS es el punto de referencia en Italia para las pruebas de laboratorio en este sector y certifica el producto en base a las normativas técnicas italianas, europeas e internacionales por lo que concierne la resistencia mecánica, las pruebas a reacción del fuego, la seguridad en la decoración, la emisión formaldehído, el análisis defectos de madera, y mucho más.

**Legno vero, che si esprime
attraverso tutta la sua forza.
Eleganza, vissuto, tradizione
e contemporaneità.
/ The strength and durability
of real wood. Elegance, legacy,
tradition, modernity.**

wood.

CREDITS:

Aqua

Dogma - New rules for the modern bathroom (Giugno 2017)

Design+AD: Ideagroup

Concept: Neiko

Images: Neiko

Printed in Italy by: Grafiche Antiga

Aqua si riserva la facoltà di modificare, in qualunque momento e senza preavviso, le caratteristiche tecniche degli elementi illustrati nel presente catalogo. Declina ogni responsabilità per eventuali inesattezze contenute nello stesso.

Aqua reserves the right to modify the technical characteristics of the elements contained in this catalogue without notice and shall not be liable for any inexactness contained herein.

Aqua behält sich das Recht vor, die technischen Eigenschaften der im vorliegenden Katalog abgebildeten Elemente jederzeit und ohne Vorbescheid zu ändern. Man lehnt jede Haftung für eventuelle im Katalog enthaltene Fehler ab.

Aqua se réserve la faculté de modifier, dans tout moment et sans avis préalable, les caractéristiques techniques des éléments montrés dans ce catalogue. L'entreprise décline toute responsabilité pour d'éventuelles inexactitudes dans le présent catalogue.

Aqua se reserva la facultad de modificar, en cualquier momento y sin previo aviso, las características técnicas de los elementos ilustrados en el presente catálogo. Idea srl declina toda responsabilidad por eventuales inexactitudes del mismo catálogo.



AQUA

Aqua srl Via Vallonto 126
31043 Vallonto di Fontanelle (TV) Italy
Tel. +39 0422 818903 Fax. +39 0422 818919
www.ideagroup.it - e-mail: aqua@ideagroup.it