

mdf italia



© COPYRIGHT 2021 MDF ITALIA SRL SOCIETA' UNIPERSONALE

2016-2019

TENSE MATERIAL WOOD

Designed by Piergiorgio Cazzaniga, Michele Cazzaniga

“A smart beauty, resulting from a thought and a know-how capable of transmitting a deep emotion through a wise accentuation of the peculiarities of the materials used”. Piergiorgio Cazzaniga describes in this way Tense Material, a collection of tables available in 5 heights and 36 sizes, capable of achieving large dimensions, up to 4 meter long, always keeping a perfect top tension.

Different wood grain combinations, various shades and emotions to be touched. Tense Material is available in three different wood essences: natural oak, carbonized oak and national walnut.

NATURAL OAK highlights wood grains and unveils time passing by, enhancing its beauty. The natural, wrinkled surface, is not just a visual experience, but also a tactile one. Every table is different from another, so every single product takes on a unique personality. This Tense Material's finish brings warmth into the living room and fits into every context and furnishing style.

Inspired to the Japanese technique, Tense CARBON starts from an oak base. By using natural acids a “burned” effect on the surface is got. Thus, wood looks black with intense and fully natural shades, that are unique and not replicable.

Tense Material FINE WOOD IN NATIONAL WALNUT combines wood durability and resistance with elegance and lightweight, that are typical features of the collection. The smooth surface features warm and intense colours, with endless shades enhancing wood features. Tense Material Fine Wood perfectly fits into classical contexts, but it also stands out in contemporary spaces.

The possibility to insert the top-access, the cable trays and its large size, make Tense Material suitable for workplaces, where meetings are so many and the need of accommodating more people around the table is frequent.

[EXPLORE THE WHOLE TENSE COLLECTION](#)

FRAME AND TABLETOPS

Tables featuring mono-material finishes.

The important technological innovation it incorporates, combined with the tensioning capacity of the components makes it possible to build tabletops in large sizes.

The 35mm thick tabletop is a load-bearing composite board built with an internal frame consisting of either aluminium profiles and polystyrene filler, except for the brass top which has an acrylic resin honeycomb filling and two outer layers of aluminium. 35x35mm steel legs with internal structural tie-rod.

The reduction of the maximum sizes of the Italian walnut version (up to D120 x L300) represents the technical limits of the materials employed to build the tabletops.

OAK WOOD AND CARBONIZED WOOD

Solid natural oak, 3 mm thickness, obtained from sustainable forests and subjected to biothermal treatment through the combined use of heat and steam, without the addition of chemicals. The wood retains its original beauty while the heat treatment changes its colour without using colouring agents, chemical dyes or harmful substances, resulting in totally natural, unique, irreplaceable hues.

Natural oak wood with transparent acrylic finish.

In the carbonized wood, the characteristic "black carbonised" effect is obtained by applying a natural acid to the surface.

FINE WOOD | Italian walnut

Solid Italian walnut, 2 mm thickness, obtained from sustainable forests and finely sanded into variously sized slats. This type of processing technique enhances the natural characteristics of the wood, granting the material different shades. Any visible design irregularities should be regarded as signs of quality and authenticity.

Transparent acrylic finish. The edges and legs are covered in 2 mm-thick cut walnut, processed with a sawed effect (series of irregular cuts of different depths).

The natural surface in variously sized slats is characterised by different shades which enhance the natural features of the wood and raw materials.

TOP-ACCESS

The tables are also available in the version equipped with 1 or 2 top-access and under top cable tray. The top-access, in size 127x350 mm, is in aluminium and is available in three versions: single lead with soft closing, double lead and optional, single lead with soft closing, with inlay in the same finish of the table.

Matt black lacquered top-access finish. It is also available in the same finish of the table, only for the stone, wood and marble versions, only for the single lead and only for the heights H73, H90 and H110.

DIMENSIONS

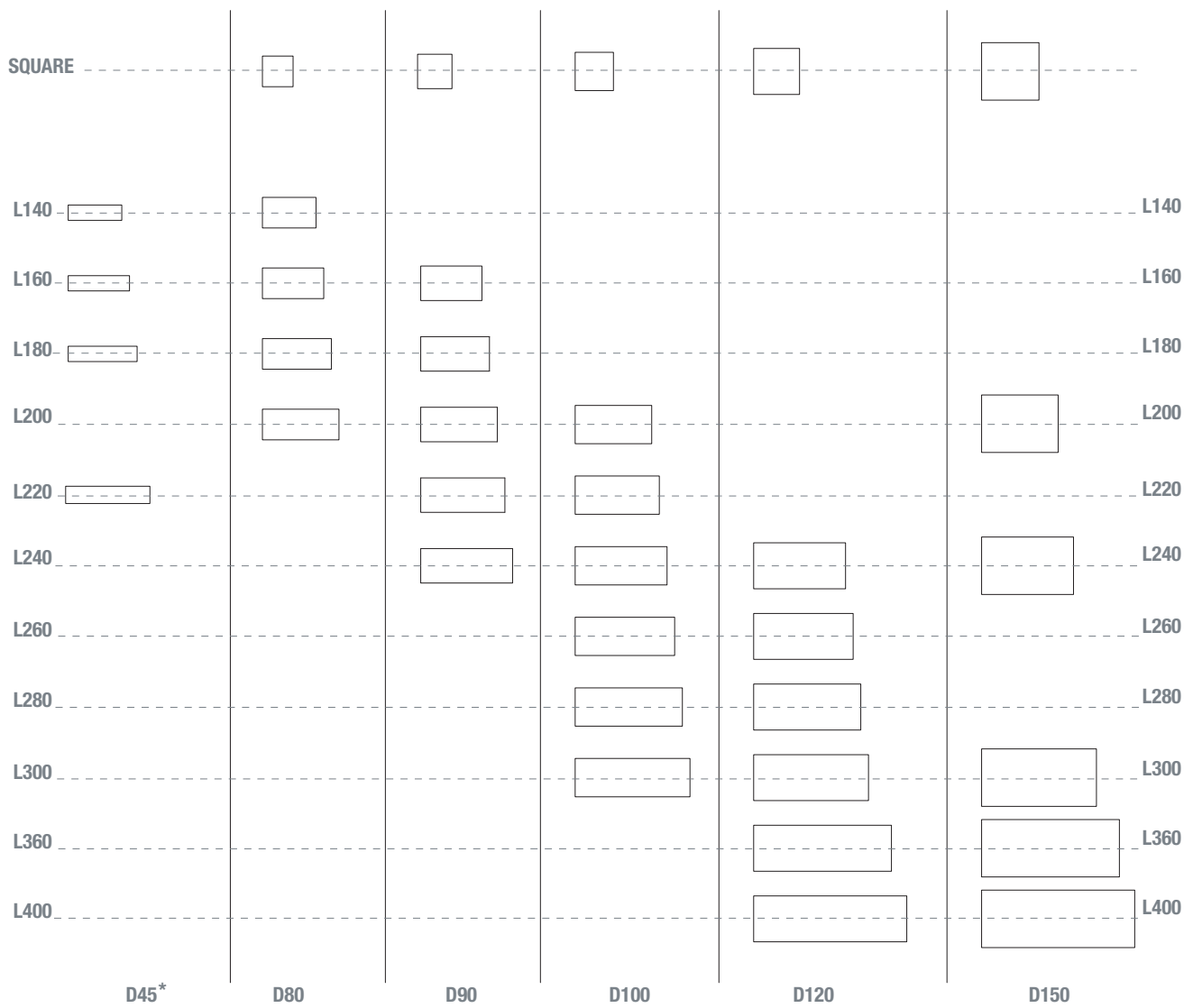
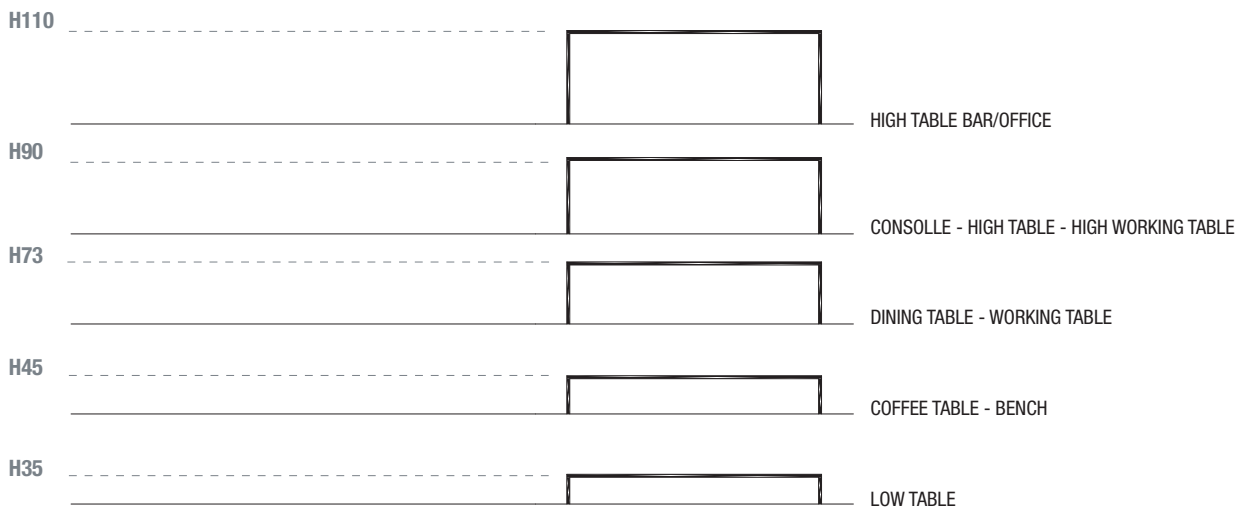

TYPE OF TOP-ACCESS L35 X H12.7 CM

A  **Single lead (with soft closing)**

B  **Double lead**

C  **Single lead (with soft closing), with inlay matching with the finish of the table.**
 The top-access is also available in the same finish of the table, only for the stone, wood and marble versions and only for the heights H73, H90 and H110.

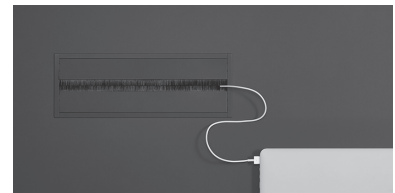

TYPE OF METAL WIREWAY (TELESCOPIC)

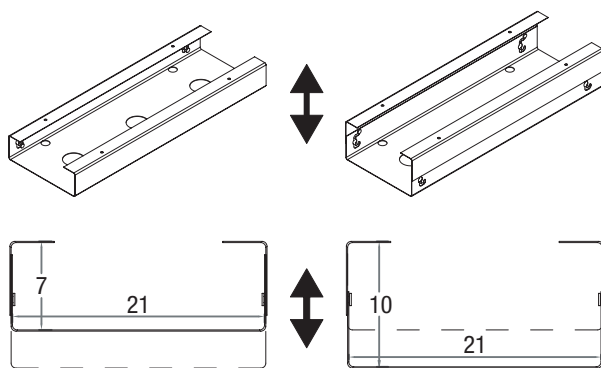

The metal cable trays are telescopic (H7/10 cm).

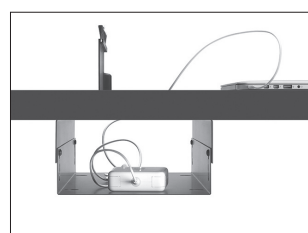
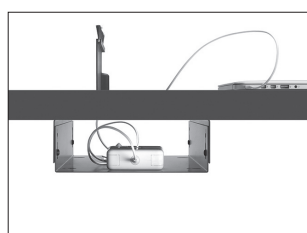

POSITION OF THE TOP-ACCESS

With one or two lateral top-access

X (cm)	Y (cm)
90	160
90	180
90	200
90	220
100	200
100	220

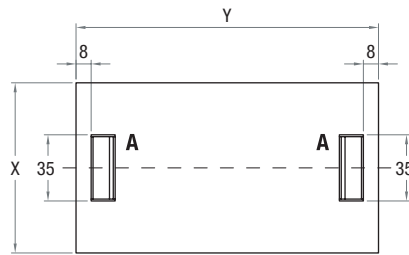

With one central top-access

X (cm)	Y (cm)
150	150
150	200
150	240

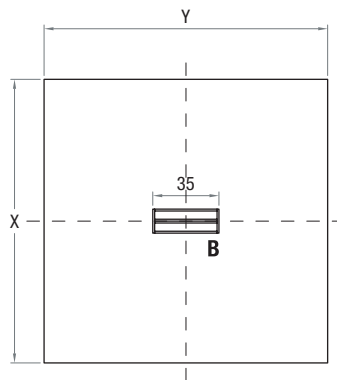

With two front top-access

X (cm)	Y (cm)	L (cm)
90	240	52
100	240	52
100	260	64
100	280	84
100	300	104
120	240	52
120	260	64
120	280	84
120	300	104
120	360	164
120	400	116

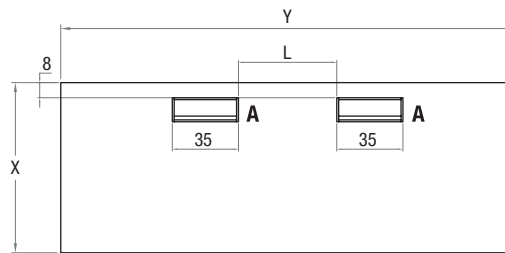

With two central top-access

X (cm)	Y (cm)	L (cm)
120	240	52
120	260	64
120	280	84
120	300	104
120	360	164
120	400	116
150	300	104
150	360	164
150	400	116

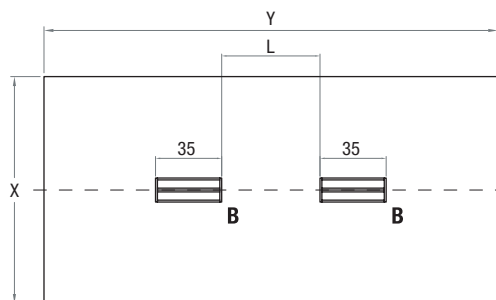

EXAMPLE OF TOP-ACCESS AND METAL WIREWAY POSITION

With one or two lateral top-access

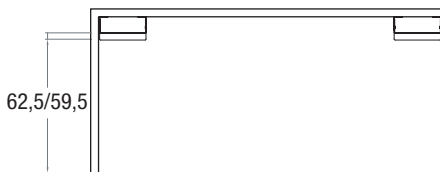
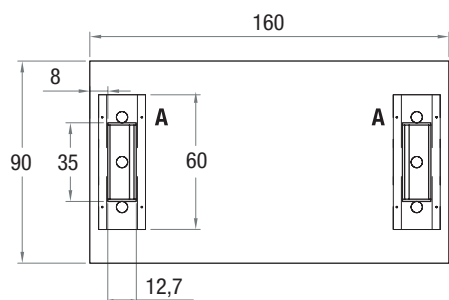

With two front top-access

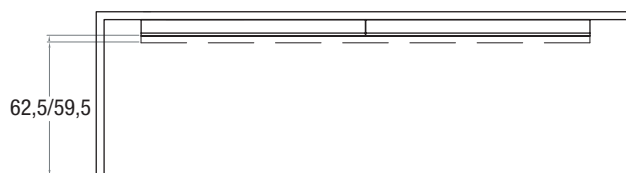
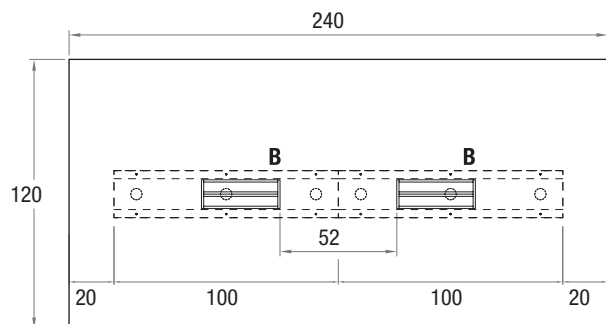

Finishing

The number in the dot corresponds to the number of colour/material finish.

Here below, in the section FINISH OPTIONS, please note all the colours of the materials used for this product.

TABLE

Top/Structure



Wood



Carbone

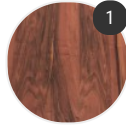

Fine Wood

Finish options

TOP/STRUCTURE

Wood



Wood X085

Carbone



Carbonised
wood X094

Fine Wood



Fine wood,
Italian walnut
X119