



Table with top in solid Kauri and resin, stylized symbol of the Earth: the wood pieces represent the continents and the resin parts the oceans. Base in dark iron, with tubular section and visible weld joints.

**STANDARD VERSION:** TOP MADE OF KAURI BLOCKS (A10) AND TRANSPARENT RESIN; DARK IRON BASE WITH TUBULAR SECTION AND VISIBLE WELDING, OILED (A1) - INCLUDED IN THE KAURI SLAB PRICE

CODE	SIZE	A10
EARTH 1	Ø 130 x H.75	■
EARTH 2	Ø 140 x H.75	■
EARTH 3	Ø 160 x H.75	■
EARTH 4	Ø 180 x H.75	■
EARTH 5	Ø 190 x H.75	■

**AVAILABLE FINISHES:**

A10: kauri

FEASIBILITY LACQUERED IRON BASE	
B2	■
B3	■

**AVAILABLE FINISHES:**

**B2:** lacquered iron: matt transparent, iron dust, RAL (only selected colours)

**B3:** lacquered iron matt brushed effect: aged copper, aged bronze, stainless steel, titanium  
lacquered iron oxidised effect

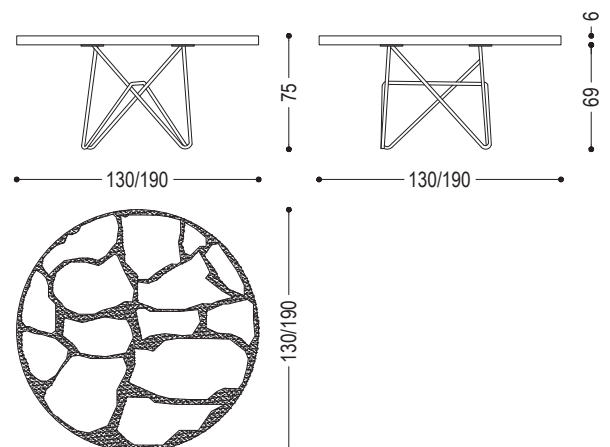

*Kauri top drawing for illustrative purposes only*

## WOOD

A10



kauri

## IRON

B2

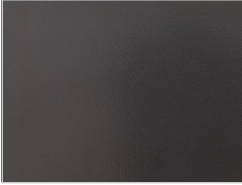

lacquered iron:  
matt transparent

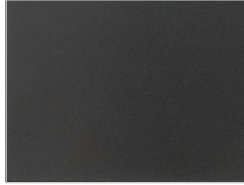

lacquered iron:  
iron dust

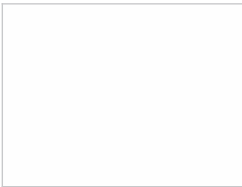

ferro laccato:  
RAL - 1013\_OYSTER WHITE



ferro laccato:  
RAL - 3020\_TRAFFIC RED

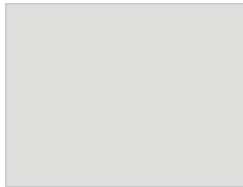

ferro laccato:  
RAL - 7035\_LIGHT GREY



ferro laccato:  
RAL - 7037\_DUSTY GREY



ferro laccato:  
RAL - 8019\_GREY BROWN

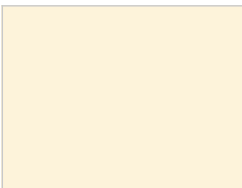

ferro laccato:  
RAL - 9001\_CREAM WHITE

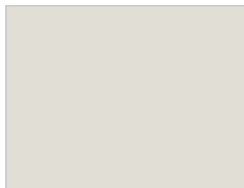

ferro laccato:  
RAL - 9002\_GREY WHITE

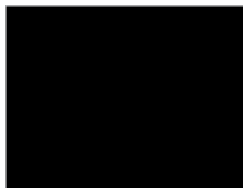

ferro laccato:  
RAL - 9005\_JET BLACK

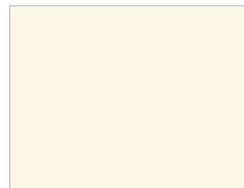

ferro laccato:  
RAL - 9010\_PURE WHITE

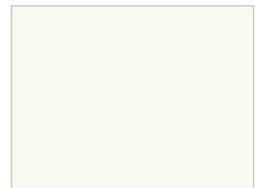

ferro laccato:  
RAL - 9016\_TRAFFIC WHITE

B3



lacquered iron, matt brushed effect:  
aged copper



lacquered iron, matt brushed effect:  
aged bronze



lacquered iron, matt brushed effect:  
stainless steel



lacquered iron, matt brushed effect:  
titanium



lacquered iron, oxidised effect