



Elegant chair with legs in solid wood and structure made of polyurethane with back and seat in continuous line. Version without armrests, with cover in leather or fabric; the back of the chair cover can be plain or with rhombus stitching.

**STANDARD VERSION: PLAIN COVER**

CODE	SIZE	LEATHER FABRIC	A1	A2	A3	A4
CLOE	W.53 x D.59 x H.48,5/85,5	D1	■	■	■	■
		D2	■	■	■	■
		D3	■	■	■	■
		D4	■	■	■	■
		D6	■	■	■	■

**AVAILABLE FINISHES:**







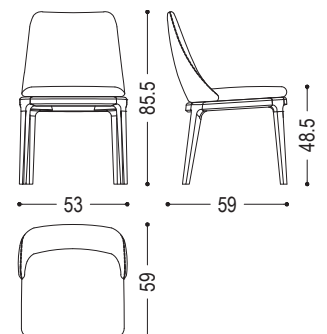



- A1:** walnut without knots, elm
- A2:** oak without knots, cherry, maple
- A3:** oak without knots finish: whitened, mystic black, neutro
- A4:** oak without knots pigmented: ash grey, white milk, total black
- D1:** fabric: canvas, divina melange 2, hallingdal 65, velvet harald
- D2:** fabric: maple
- D3:** leather: camoscio, cristal
- D4:** leather: nabuk
- D6:** COL, COM

**FEASIBILITY OPTION ON LEATHER / FABRIC**





RHOMBUS STITCHING ON THE BACK SIDE	■
------------------------------------	---



## WOOD

A1			
	walnut without knots	elm	
A2			
	oak without knots	cherry	maple
A3			
	oak without knots finish: whitened	oak without knots finish: mystic black	oak without knots finish: neutro
A4			
	oak without knots pigmented: ash grey	oak without knots pigmented: white milk	oak without knots pigmented: total black

LEATHER / FABRIC

D1					
	<p>fabric: canvas: 114</p>	<p>fabric: canvas: 124</p>	<p>fabric: canvas: 134</p>	<p>fabric: canvas: 154</p>	<p>fabric: canvas: 174</p>
					
	<p>fabric: divina melange 2: 120</p>	<p>fabric: divina melange 2: 170</p>	<p>fabric: divina melange 2: 180</p>	<p>fabric: divina melange 2: 220</p>	<p>fabric: divina melange 2: 260</p>
					
	<p>fabric: divina melange 2: 280</p>	<p>fabric: hallingdal 65: 103</p>	<p>fabric: hallingdal 65: 116</p>	<p>fabric: hallingdal 65: 130</p>	<p>fabric: hallingdal 65: 166</p>
					
	<p>fabric: hallingdal 65: 180</p>				
					
	<p>velvet fabric: harald: 182</p>	<p>velvet fabric: harald: 242</p>	<p>velvet fabric: harald: 283</p>	<p>velvet fabric: harald: 443</p>	<p>velvet fabric: harald: 512</p>
					
<p>velvet fabric: harald: 552</p>	<p>velvet fabric: harald: 582</p>	<p>velvet fabric: harald: 792</p>	<p>velvet fabric: harald: 982</p>		



# CLOE | AVAILABLE FINISHES

D2

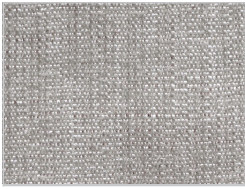

fabric:  
maple:  
112

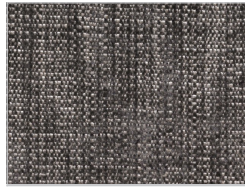

fabric:  
maple:  
132

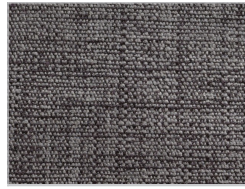

fabric:  
maple:  
142



fabric:  
maple:  
162



fabric:  
maple:  
192



fabric:  
maple:  
222

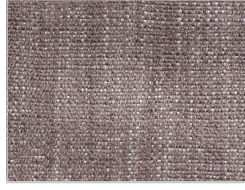

fabric:  
maple:  
232



fabric:  
maple:  
362



fabric:  
maple:  
742



fabric:  
maple:  
792

D3



Leather camoscio:  
1



Leather camoscio:  
10



Leather camoscio:  
11



Leather camoscio:  
26



Leather camoscio:  
27



Leather camoscio:  
28



Leather camoscio:  
31



Leather cristal:  
13



Leather cristal:  
14



Leather cristal:  
17



Leather cristal:  
18

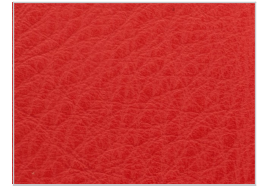

Leather cristal:  
37



Leather cristal:  
49



Leather cristal:  
51



Leather cristal:  
65



Leather cristal:  
70



# CLOE | AVAILABLE FINISHES

D4



Leather nabuk:  
101



Leather nabuk:  
102



Leather nabuk:  
103



Leather nabuk:  
104



Leather nabuk:  
105



Leather nabuk:  
106

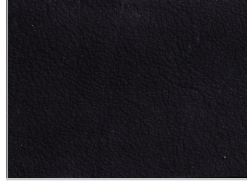

Leather nabuk:  
107

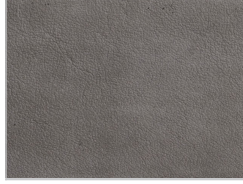

Leather nabuk:  
108

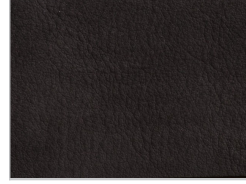

Leather nabuk:  
109