



Table with top in glued solid wood lists, with natural sides, combined with a basic and linear base made of intertwined tubular iron, empty inside. Upon request available in intertwined full tubular iron.

STANDARD VERSION: EMPTY INTERTWINED IRON TUBULAR BASE (WEIGHT 20 KG) LACQUERED IRONDUST COLOUR (B2)

CODE	SIZE	A1	A2	A3	A4	A5
IRON LIGHT NS 4	W.200 x D.100 x H.75,5	■	■	■	■	■
IRON LIGHT NS 5	W.220 x D.100 x H.75,5	■	■	■	■	■
IRON LIGHT NS 6	W.240 x D.100 x H.75,5	■	■	■	■	■
IRON LIGHT NS 7	W.260 x D.100 x H.75,5	■	■	■	■	■
IRON LIGHT NS 8	W.280 x D.100 x H.75,5	■	■	■	■	■
IRON LIGHT NS 9	W.300 x D.100 x H.75,5	■	■	■	■	■

AVAILABLE FINISHES:

- A1:** walnut with knots
- A2:** oak with knots
- A3:** oak with knots finish: whitened, mystic black, vintage, neutro
- A4:** oak with knots pigmented: ash grey, white milk, total black
- A5:** oak: flamed london, with knots vulcano, with knots tobacco

FEASIBILITY LACQUERED IRON BASE	
B2	■
B3	■

AVAILABLE FINISHES:

- B2:** lacquered iron: iron dust, RAL (only selected colours)
- B3:** lacquered iron matt brushed effect: aged copper, aged bronze, stainless steel, titanium
lacquered iron oxidised effect

FEASIBILITY BASE IN INTERTWINED FULL TUBULAR IRON	
B2	■
B3	■

AVAILABLE FINISHES:

- B2:** lacquered iron: iron dust, RAL (only selected colours)
- B3:** lacquered iron matt brushed effect: aged copper, aged bronze, stainless steel, titanium
lacquered iron oxidised effect

DETAIL: TOP WITH NATURAL SIDES

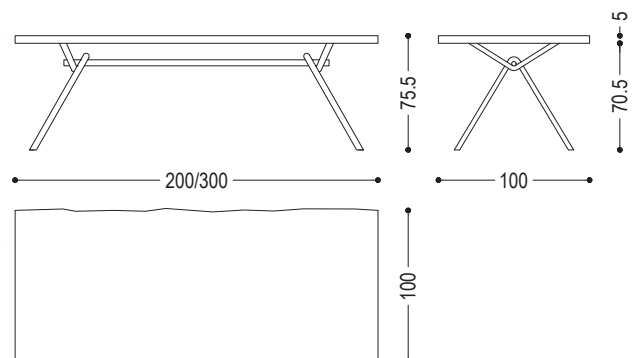

IRON LIGHT NATURAL SIDES | AVAILABLE FINISHES

WOOD

A1

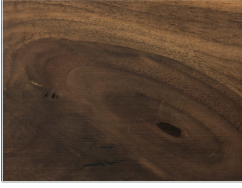

walnut with knots

A2



oak with knots

A3



oak with knots finish:
whitened



oak with knots finish:
mystic black



oak with knots finish:
vintage



oak with knots finish:
neutro

A4



oak with knots pigmented:
ash grey



oak with knots pigmented:
white milk



oak with knots pigmented:
total black

A5



oak:
flamed london













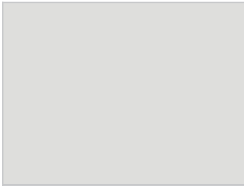

oak:
with knots vulcano

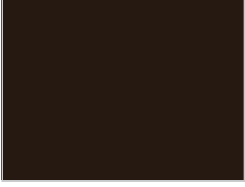
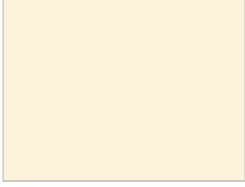
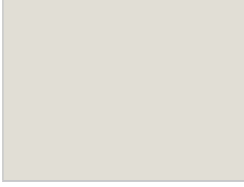

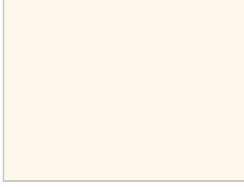
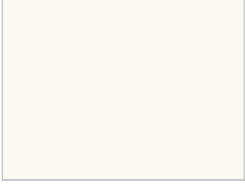
oak:
with knots tabacco

IRON LIGHT NATURAL SIDES | AVAILABLE FINISHES

IRON

B2					
	lacquered iron: iron dust	ferro laccato: RAL - 1013_OYSTER WHITE	ferro laccato: RAL - 3020_TRAFFIC RED	ferro laccato: RAL - 7035_LIGHT GREY	ferro laccato: RAL - 7037_DUSTY GREY
					
	ferro laccato: RAL - 8019_GREY BROWN	ferro laccato: RAL - 9001_CREAM WHITE	ferro laccato: RAL - 9002_GREY WHITE	ferro laccato: RAL - 9005_JET BLACK	ferro laccato: RAL - 9010_PURE WHITE
					
	ferro laccato: RAL - 9016_TRAFFIC WHITE				
B3					
	lacquered iron, matt brushed effect: aged copper	lacquered iron, matt brushed effect: aged bronze	lacquered iron, matt brushed effect: stainless steel	lacquered iron, matt brushed effect: titanium	lacquered iron, oxidised effect