

FLAT

Rimadesio



A CONSTANTLY EVOLVING TABLE SYSTEM, WITH A WIDE VARIETY OF SIZES CAPABLE OF INTERPRETING DIFFERENT ENVIRONMENTS AND FUNCTIONS, FROM DOMESTIC SITUATIONS TO PROFESSIONAL SPACES. THE FLAT RANGE ENHANCES THE QUALITIES OF RIMADESIO'S FUNDAMENTAL MATERIALS, ALUMINIUM AND GLASS. IT ADOPTS A RIGOROUS DESIGN, USING LIGHT PROPORTIONS AND MAKING A SUBTLE NOD TO THE AESTHETICS OF RATIONALISM. A SOLUTION WHOSE FORMAL SIMPLICITY ALLOWS IT TO INTEGRATE SEAMLESSLY WITH ALL SYSTEMS IN THE COMPANY'S COLLECTION.

IT Un sistema tavoli in continua evoluzione, con un'ampia varietà dimensionale in grado di interpretare ambienti e funzioni diverse, dalle situazioni domestiche agli spazi professionali. Flat è una proposta che valorizza al meglio le qualità dei materiali fondamentali Rimadesio, alluminio e vetro, attraverso un design rigoroso, fra proporzioni leggere e sottili rimandi all'estetica del razionalismo. Una soluzione che nella propria semplicità formale diventa in grado di integrarsi perfettamente con tutti i sistemi della collezione aziendale.

DE Ein sich ständig weiterentwickelndes Tischsystem mit einer großen Vielfalt an Abmessungen, das sich diversen Umgebungen und Funktionen anpasst - von Wohn- bis hin zu Geschäftsräumen. Flat ist eine Möbellinie, die die Qualitäten der grundlegenden Rimadesio-Materialien Aluminium und Glas durch ein rigoroses Design zwischen leichten Proportionen und subtilen Verweisen auf die Ästhetik des italienischen Rationalismus optimal zur Geltung bringt. Eine Lösung, die sich dank ihrer formalen Schlichtheit nahtlos in alle Systeme unserer Kollektionen einfügt.

FR Un système de tables en constante évolution, proposant de nombreuses tailles et capable d'interpréter différents espaces et fonctions, domestiques ou professionnels. Flat est une solution imaginée pour souligner au maximum les qualités des matériaux fondamentaux Rimadesio, l'aluminium et le verre, à travers un design rigoureux, entre proportions légères et références subtiles à l'esthétique du rationalisme. Une solution qui, dans sa simplicité formelle, s'intègre à la perfection à tous les systèmes de la collection de la marque.

ES Un sistema de mesas en constante evolución, con una gran variedad de tamaños para diferentes ambientes y funciones, desde entornos domésticos hasta espacios profesionales. Flat es una propuesta que potencia las cualidades de los materiales fundamentales de Rimadesio, el aluminio y el cristal, a través de un diseño riguroso, entre proporciones ligeras y sutiles que hacen referencia a la estética del racionalismo. Una solución que en su sencillez formal es capaz de integrarse perfectamente con todos los sistemas de la colección de empresa.

RU Непрерывно обновляемая система столов большого ассортимента размеров, которая может гармонично внедряться в различных помещениях: от бытовых до профессиональных пространств. Flat — это предложение, максимально использующее качества основных материалов Rimadesio — алюминия и стекла, — благодаря строгому дизайну, легким пропорциям и эстетике рационализма. Решение, которое при своей формальной простоте способно легко интегрироваться со всеми системами, входящими в коллекцию компании.

汉语 Flat 桌面系统不断进化并通过多样尺寸来诠释各式的空间与功能，从居家空间到专业办公空间皆合适。Flat 的设计充分突出了 Rimadesio 基本材质——铝合金和玻璃的高质量，通过严谨的设计，各个轻盈、细腻的比例之间，呼应理性主义的设计美学。这项造型简洁的解决方案能完美融入办公系列的所有系统。





Structure: 83 piombo
Wooden top: 19 rovere termotrattato

TABLES / FLAT



Structure: 304 platino
Wooden top: 15 noce

EN The Flat table system offers maximum freedom to design with colours: the structure is available in anodised aluminium, brown, nero, bianco latte and in matt lacquered finishings of the 44 Ecolorsystem colours. A variety that allows monochromatic combinations between aluminium and glossy glasses, in 39 colours, mat glasses, in 39 colours, 14 metalized glass and 3 wood finishings.

IT Il sistema di tavoli Flat offre la massima libertà di progettare con i colori: la struttura è disponibile in alluminio finitura anodizzata, brown, nero, bianco latte e in finitura laccata opaca nelle 44 tinte Ecolorsystem. Una varietà che consente di creare abbinamenti monocromatici fra alluminio e i vetri laccati lucidi, in 39 colori, e opachi, in 39 colori, i 14 vetri metallizzati e le 3 essenze.

DE Das Tischsystem Flat bietet in puncto Farben maximale Gestaltungsfreiheit: Die Struktur ist in eloxiertem Aluminium, brown, nero, bianco latte sowie in matt lackiert in den 44 Ecolorsystem-Farben erhältlich. Eine Vielfalt, die es Ihnen ermöglicht, einfarbige Kombinationen zwischen Aluminium und glänzend lackiertem Glas in 39 Farben sowie Mattglas in 39 Farben, den 14 Metallglasfarben und den 3 Holzarten zu schaffen.

FR Le système de tables Flat offre une grande liberté côté nuances: la structure est en effet disponible en aluminium avec finition anodisée, brown, nero, bianco latte et en finition laquée mate dans les 44 couleurs Ecolorsystem. Une variété qui permet de créer des combinaisons monochromes entre l'aluminium et le verre laqué brillant, proposé en 39 couleurs, et mat, proposé en 39 couleurs, sans oublier les 14 verres métallisés et les 3 essences de bois.

ES El sistema de mesas Flat ofrece la máxima libertad para diseñar con los colores: la estructura está disponible en aluminio con acabado anodizado, brown, nero, bianco latte y en acabado lacado mate en los 44 colores Ecolorsystem. Una variedad que permite crear combinaciones monocromáticas entre aluminio y cristal lacado brillante, en 39 colores, y opaco, en 39 colores, los 14 cristales metalizados y los 3 tipos de madera.

RU Система столов Flat — максимальная свобода в выборе цвета: конструкция доступна в анодированном алюминии, коричневом, черном, молочно-белом и матовом лаковом покрытии 44 цветов Ecolorsystem. Разнообразие позволяет создавать монохромные сочетания алюминия и глянцевого лакированного стекла 39 цветов, матового стекла 39 цветов, 14 металлизированных цветов стекла и 3 натуральных пород дерева.

汉语 Flat 桌子系统赋予色彩设计方面最大的灵活性: 结构材质为铝合金, 并有阳极氧化、棕、黑、牛奶白以及 Ecolorsystem 中44 款哑光漆面颜色等表面处理可供选择。众多材质选择可用于创造各式单色组合, 从铝合金到 3 种木材, 再到 14 种金属化玻璃、39 种亮面漆玻璃和 39 种哑光漆玻璃。





EXCLUSIVE TECHNICAL FEATURES

Integrated multiple socket for table with glass and wooden top

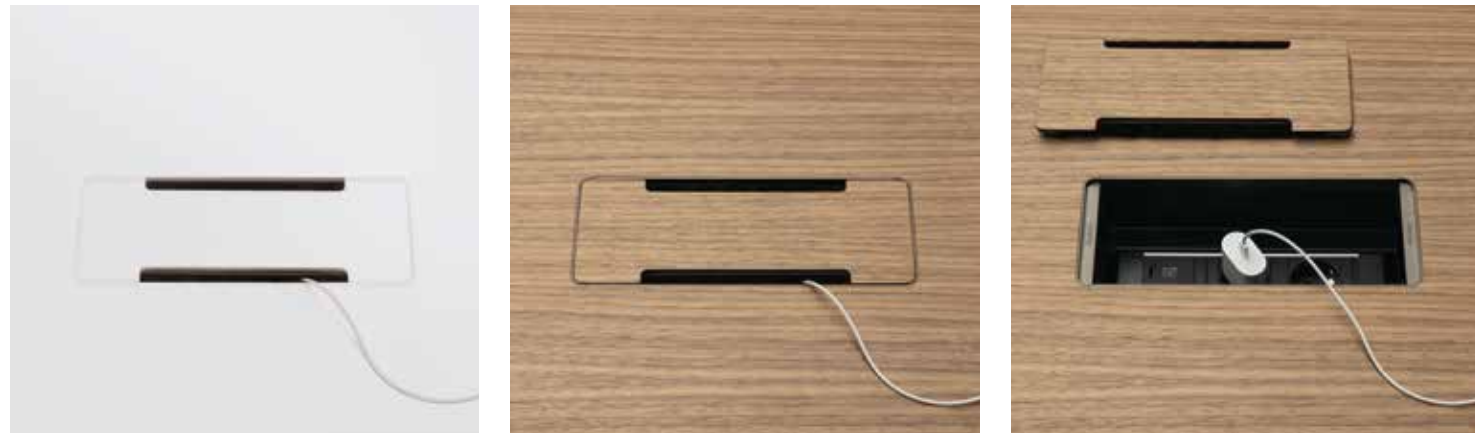

DIMENSIONS

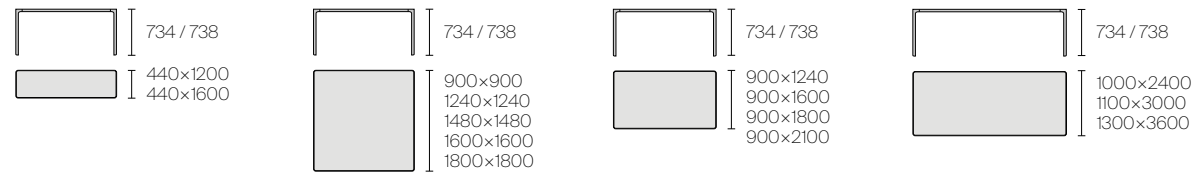

TECHNICAL SPECIFICATIONS

Glass top

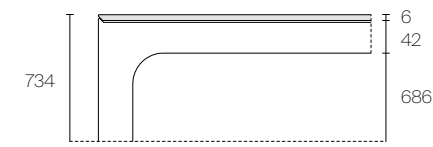

Glass top for 2400x1000, 3000x1100, 3600x1300 tables

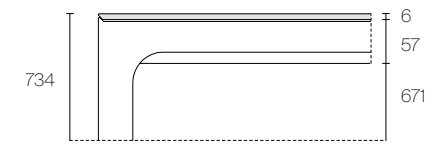

Wooden top

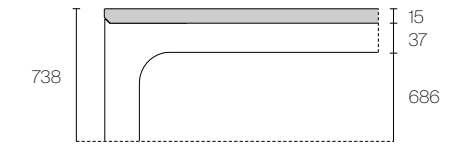

Wooden top for 2400x1000, 3000x1100, 3600x1300 tables

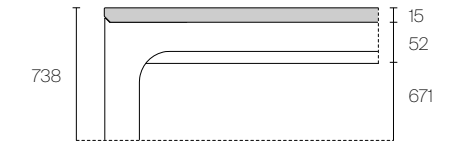

FINISHINGS

Structure

MATT LACQUERED



39 colours

LACQUERED METALIZED



7 colours

ALUMINIUM

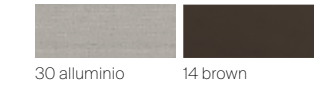

30 alluminio

14 brown

Top

LACQUERED GLASS



glossy, matt

78 colours

METALIZED GLASS



glossy, matt

14 colours

WOOD



15 noce

19 rovere termo.

27 rovere nero



A SYSTEM OF TABLES DESIGNED FOR PROFESSIONAL SPACES WITH EXTRUDED ALUMINIUM STRUCTURE AND GLASS TOP. NATURAL EVOLUTION OF FLAT TABLE, FLAT SYSTEM PROVIDES FOR CONFIGURATIONS WITH TERMINAL AND SIDE WORKSPACE AND A WIDE RANGE OF SPECIFIC EQUIPMENT AND ACCESSORIES. THE PROPOSAL ALLOWS TO MEET THE TYPICAL NEEDS OF THE NEW WORKING AREAS, PROVIDING PRACTICAL AND FUNCTIONAL SOLUTIONS FOR EVERY OPERATING CONDITION.

IT Sistema di tavoli attrezzati per spazi professionali con struttura in alluminio estruso e piani in vetro. Naturale evoluzione del tavolo, Flat System prevede configurazioni con elementi terminali, laterali e un'ampia serie di attrezzature e accessori specifici. La proposta permette di interpretare le tipiche esigenze dei nuovi spazi di lavoro, fornendo soluzioni concrete e funzionali per ogni condizione operativa.

DE Ein Tischsystem für professionelle Räume, das mit extrudierter Aluminium-Struktur und Glas-platten ausgestattet ist. Flat System ist die natürliche Evolution des Tisches und bietet Verbindungen mit End- und Seitenelementen und eine große Bandbreite an spezifischen Geräten und Zubehör. Das Angebot ermöglicht es, die typischen Bedürfnisse neuer Arbeitsräume zu interpretieren und praktische und funktionelle Lösungen für jeden Betriebszustand anzubieten.

FR Système de tables équipées pour les espaces professionnels avec structure en aluminium extrudé et plateau en verre. Évolution naturelle de la table, Flat System fournit des configurations avec des éléments d'extrémité, latéraux et une large gamme d'équipements et d'accessoires spécifiques. La proposition permet d'interpréter les besoins typiques des nouveaux espaces de travail, en fournissant des solutions pratiques et fonctionnelles pour chaque condition de fonctionnement.

ES Sistema de mesas equipadas para espacios profesionales con estructura en aluminio extruido y encimeras en cristal. Evolución natural de la mesa, Flat System prevé configuraciones con elementos terminales, laterales y una amplia gama de equipos y accesorios específicos. La propuesta permite interpretar las necesidades típicas de los nuevos espacios de trabajo, proporcionando soluciones prácticas y funcionales para cada condición operativa.

RU Система рабочих столов для профессиональных помещений с каркасом из экструдированного алюминия и стеклянными столешницами. Система Flat включает в себя конфигурации с торцевыми и боковыми элементами, а также широкий ассортимент специального оборудования и аксессуаров. В ней воплощены стандартные требования к новым рабочим пространствам с конкретными и функциональными решениями для любых условий эксплуатации.

汉语 这套设备桌系统为专业性办公空间设计，结构框架为挤出铝合金，桌面材质为玻璃。Flat 桌子系统自然演进，提供带有末端与侧边组合件以及各种特殊设备和配件的配置。这项提案满足新式工作空间的典型需求，为所有工作环境打造实际与功能兼具的解决方案。



Linear composition with terminal workspace
Structure: 53 bianco neve
Glass top: 95 bianco neve opaco
Glass upstand: O2 acidato extrachiaro
Document holders: 53 bianco neve
W 5600 H 734 D 1610

In this photo
Wall partition system: Spazio
Sliding doors: Velaria





Glass unit with three drawers on wheels
Drawer glass fronts, sides and back panel:
95 bianco neve opaco
Glass top: 115 grigio cenere opaco
W 438 H 649 D 454



Aluminum shelves support: 30 alluminio
Glass top: 95 bianco neve opaco
Shelf: 53 bianco neve
Glass upstand: 02 acidato extrachiaro



Cross composition with terminal workspace
Structure: 53 bianco neve
Glass top: 95 bianco neve opaco
Shelf: 58 caffè
Document holder: 51 nocciola
W 4400 H 734 D 3610

In this photo
Wall partition system: Spazio
Sliding doors: Sail
Sideboard: Sell bold

Linear composition

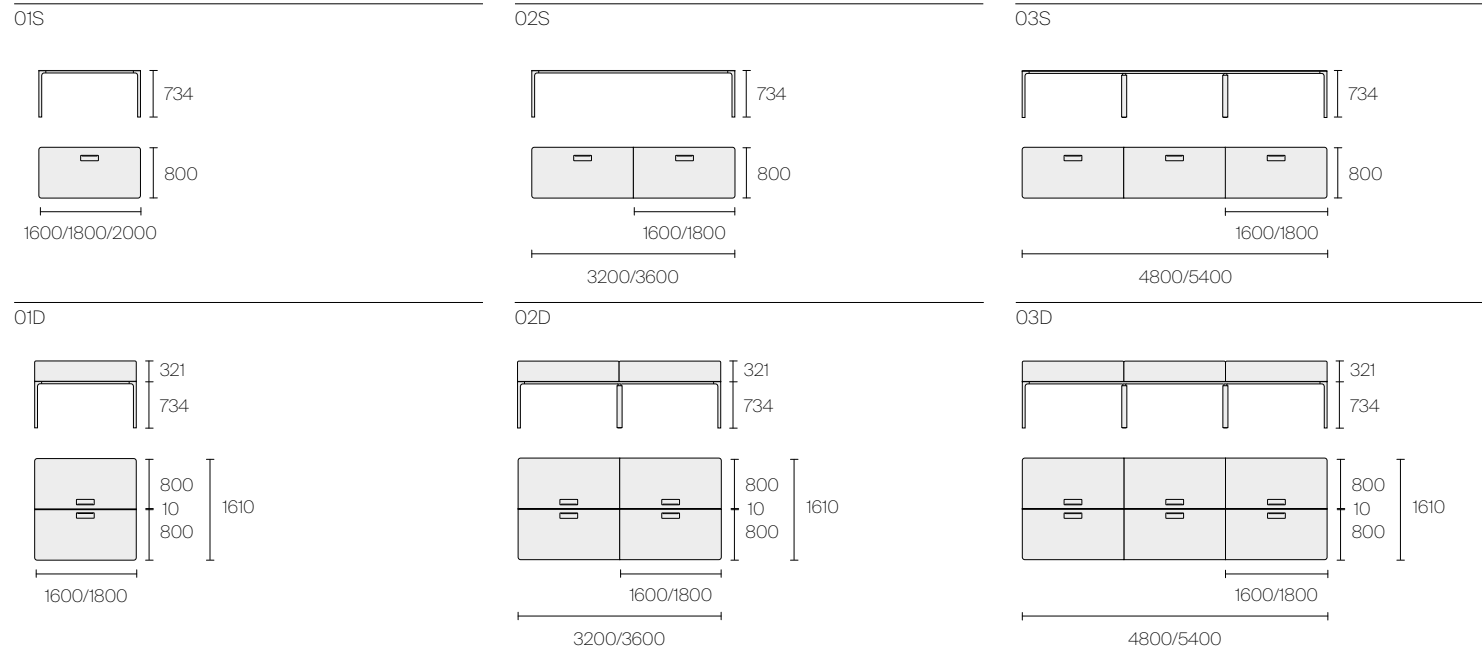

Linear composition with terminal workspace

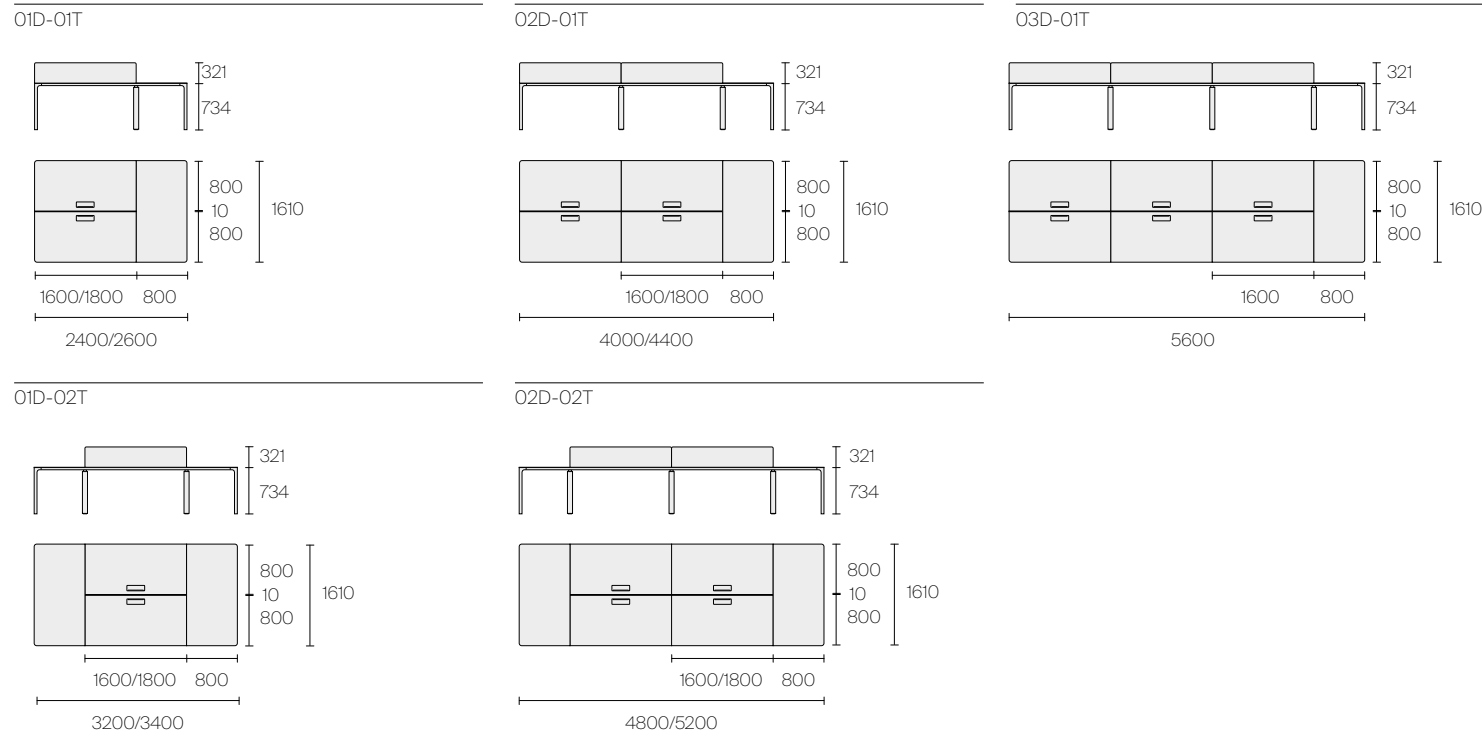

Corner compositions with side and terminal workspace

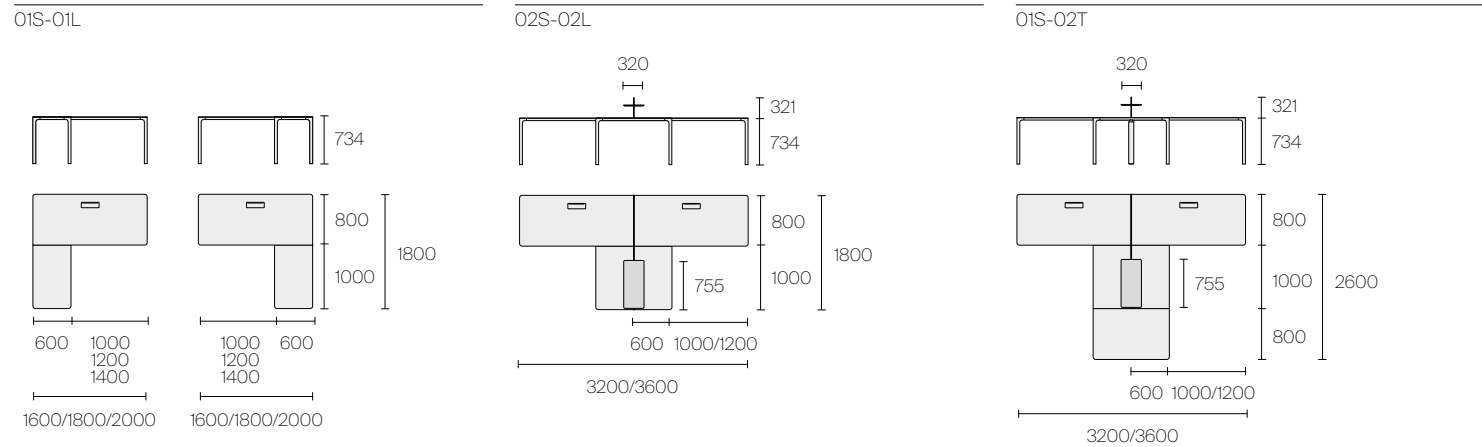

Corner compositions with side and terminal workspace

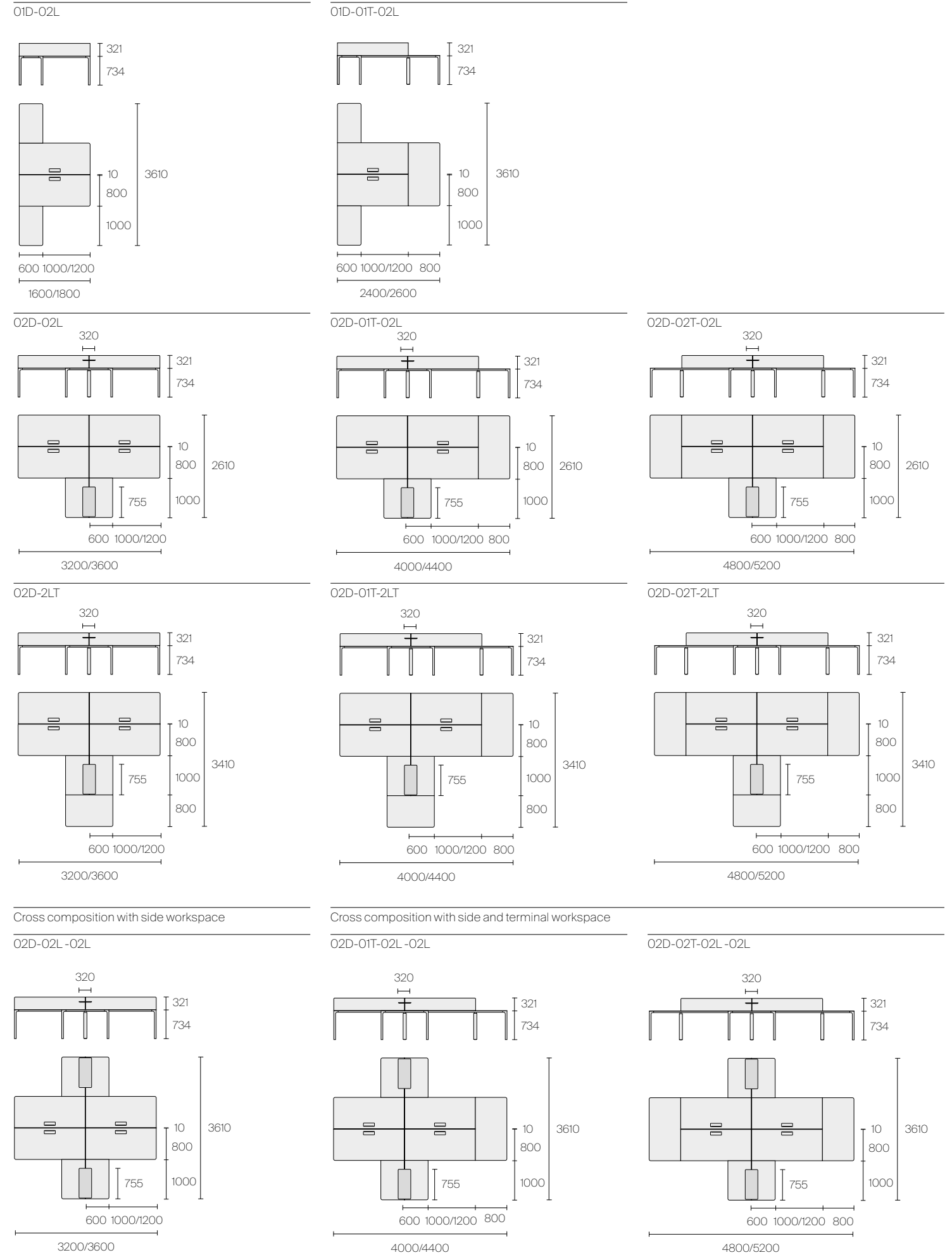

Cross composition with side workspace

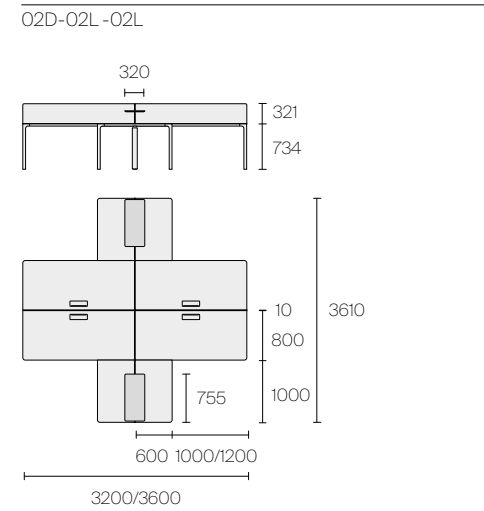

Cross composition with side and terminal workspace

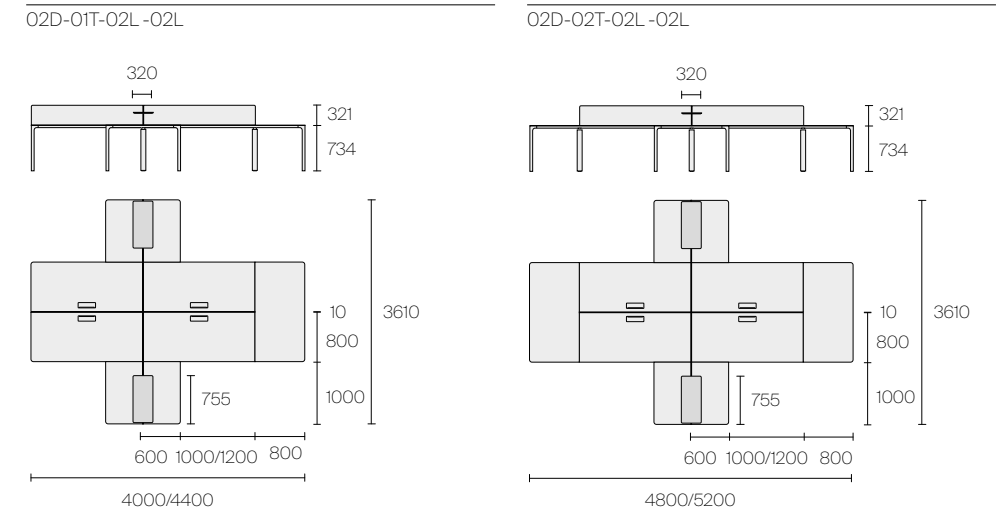

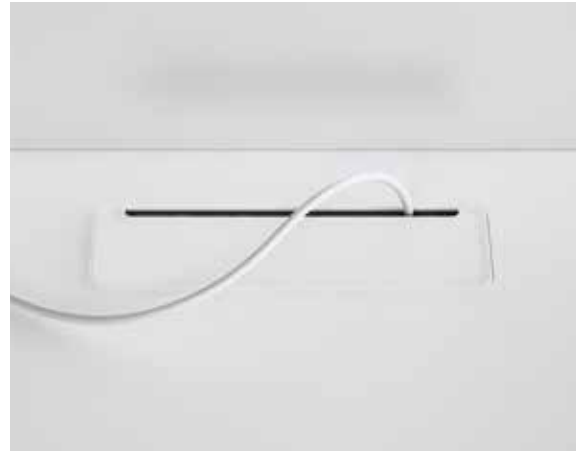

1

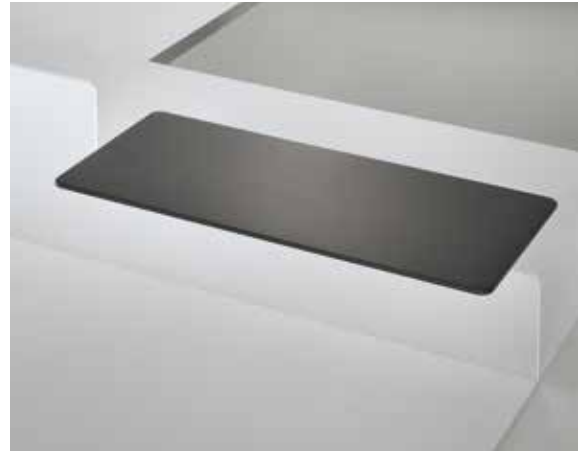

2

1. Cable duct
2. Upstand and shelf
3. Document holder in painted metal
4. Adjustable height foot



3



4

Heights

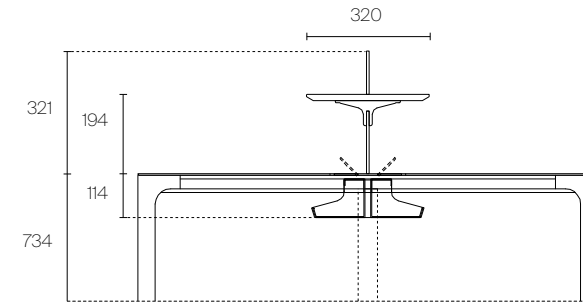

Glass top

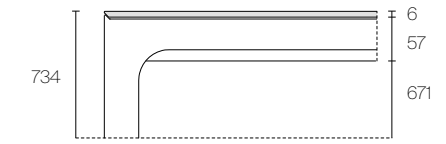

FINISHINGS

Structure

MATT LACQUERED

53 bianco neve

Glass top

MATT LACQUERED

95 bianco neve

Document holder in painted metal

MATT LACQUERED

39 colours

LACQUERED METALIZED

7 colours

ALUMINIUM

14 brown

Glass cable duct and aluminum cable ties

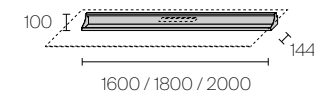
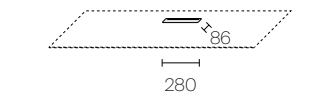

Glass unit with two or three drawers on wheels

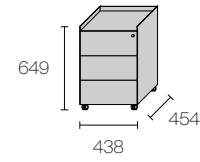
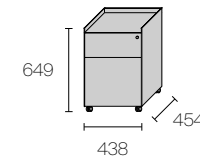

Glass upstand with and without shaping

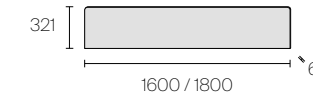
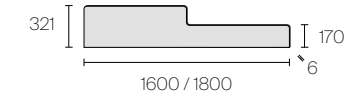

Shelf in lacquered wood

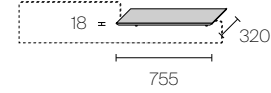

Shelf in lacquered wood

MATT LACQUERED

39 colours

LACQUERED METALIZED

7 colours

ALUMINIUM

14 brown

Structure and top

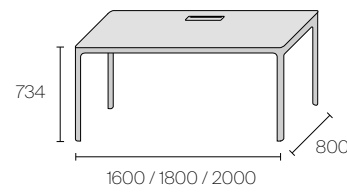

Document holder in painted metal

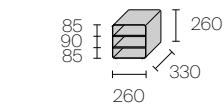

Structural metal leg with and without spiral cable guide

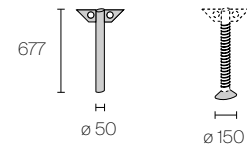

PC tower holder

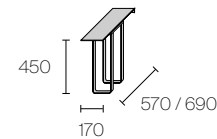

Tower pc holder

MATT LACQUERED

13 nero

Cable duct

ALUMINIUM

30 alluminio

Glass upstand with and without shaping

SATINATED GLASS

02 acidato extrach.

Top glass unit

LACQUERED GLASS

115 grigio cenere

Glass unit with two or three drawers on wheels

MATT LACQUERED

39 colours

LACQUERED METALIZED

7 colours

ALUMINIUM

30 alluminio

LACQUERED GLASS

matt

39 colours