



Armchair made from a single block of scented cedar. Distinguished by its enveloping and ergonomic body in a continuous line from the seat to the back. Upon request cushion in fabric or leather with visible stitching. Base with tubular leg and iron plate.

STANDARD VERSION: BRUSHED NATURAL IRON BASE, LIGHT COLOUR, TRANSPARENT LACQUERED (B2), REVOLVING

CODE	SIZE	A7	A8	A9
COLLYBIA DRYOPHILA	W.78 x D.66,5 x H.41,5/74	■	■	■

AVAILABLE FINISHES:

- A7: cedar
- A8: sandblasted cedar
- A9: cedar contract finish, vulcano cedar

FEASIBILITY SEAT CUSHION	
D1	■
D2	■
D3	■
D4	■
D6	■

FEASIBILITY LACQUERED IRON BASE	
B2	■
B3	■

AVAILABLE FINISHES:

- B2: lacquered iron: matt transparent, iron dust, RAL (only selected colours)
- B3: lacquered iron matt brushed effect: aged copper, aged bronze, stainless steel, titanium
lacquered iron oxidised effect

AVAILABLE FINISHES:

- D1: fabric: canvas, divina melange 2, hallingdal 65, velvet harald
- D2: fabric: maple
- D3: leather: camoscio, cristal
- D4: leather: nabuk, utah
- D6: COL, COM

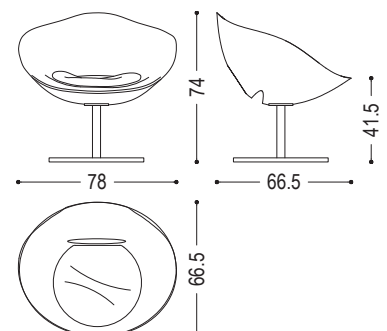

WOOD

A7



cedarwood

A8



sandblasted cedarwood

A9





cedarwood contract finish



vulcano cedarwood

LEATHER / FABRIC

D1					
	<p>fabric: canvas: 114</p>	<p>fabric: canvas: 124</p>	<p>fabric: canvas: 134</p>	<p>fabric: canvas: 154</p>	<p>fabric: canvas: 174</p>
					
	<p>fabric: divina melange 2: 120</p>	<p>fabric: divina melange 2: 170</p>	<p>fabric: divina melange 2: 180</p>	<p>fabric: divina melange 2: 220</p>	<p>fabric: divina melange 2: 260</p>
					
	<p>fabric: divina melange 2: 280</p>	<p>fabric: hallingdal 65: 103</p>	<p>fabric: hallingdal 65: 116</p>	<p>fabric: hallingdal 65: 130</p>	<p>fabric: hallingdal 65: 166</p>
					
	<p>fabric: hallingdal 65: 180</p>				
					
	<p>velvet fabric: harald: 182</p>	<p>velvet fabric: harald: 242</p>	<p>velvet fabric: harald: 283</p>	<p>velvet fabric: harald: 443</p>	<p>velvet fabric: harald: 512</p>
					
<p>velvet fabric: harald: 552</p>	<p>velvet fabric: harald: 582</p>	<p>velvet fabric: harald: 792</p>	<p>velvet fabric: harald: 982</p>		

COLLYBIA | AVAILABLE FINISHES

D2

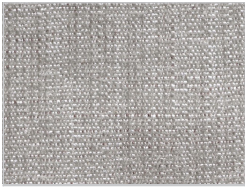

fabric:
maple:
112

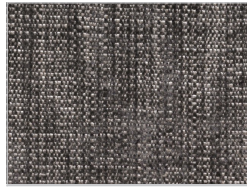

fabric:
maple:
132

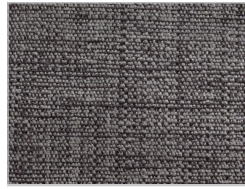

fabric:
maple:
142



fabric:
maple:
162



fabric:
maple:
192



fabric:
maple:
222



fabric:
maple:
232



fabric:
maple:
362

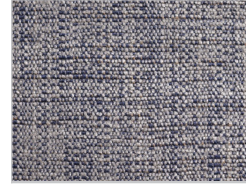

fabric:
maple:
742



fabric:
maple:
792

D3



Leather camoscio:
1



Leather camoscio:
10



Leather camoscio:
11



Leather camoscio:
26



Leather camoscio:
27



Leather camoscio:
28



Leather camoscio:
31



Leather cristal:
13



Leather cristal:
14



Leather cristal:
17



Leather cristal:
18

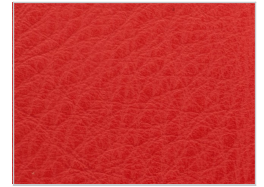

Leather cristal:
37



Leather cristal:
49



Leather cristal:
51



Leather cristal:
65

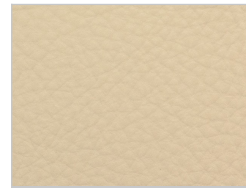

Leather cristal:
70

COLLYBIA | AVAILABLE FINISHES

D4

				
Leather nabuk: 101	Leather nabuk: 102	Leather nabuk: 103	Leather nabuk: 104	Leather nabuk: 105
				
Leather nabuk: 106	Leather nabuk: 107	Leather nabuk: 108	Leather nabuk: 109	
				
Leather utah: 101	Leather utah: 102	Leather utah: 103	Leather utah: 104	Leather utah: 105
				
Leather utah: 106	Leather utah: 107	Leather utah: 108		

IRON

B2

				
lacquered iron: matt transparent	lacquered iron: iron dust			
				
ferro laccato: RAL - 1013_OYSTER WHITE	ferro laccato: RAL - 3020_TRAFFIC RED	ferro laccato: RAL - 7035_LIGHT GREY	ferro laccato: RAL - 7037_DUSTY GREY	ferro laccato: RAL - 8019_GREY BROWN
				
ferro laccato: RAL - 9001_CREAM WHITE	ferro laccato: RAL - 9002_GREY WHITE	ferro laccato: RAL - 9005_JET BLACK	ferro laccato: RAL - 9010_PURE WHITE	ferro laccato: RAL - 9016_TRAFFIC WHITE

COLLYBIA | AVAILABLE FINISHES

B3



lacquered iron, matt brushed effect:
aged copper



lacquered iron, matt brushed effect:
aged bronze

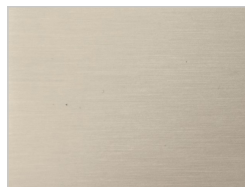

lacquered iron, matt brushed effect:
stainless steel



lacquered iron, matt brushed effect:
titanium



lacquered iron, oxidised effect