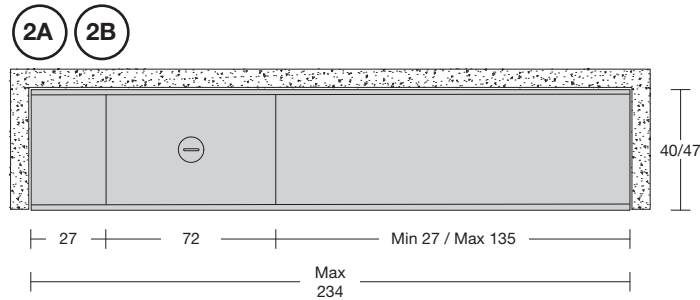
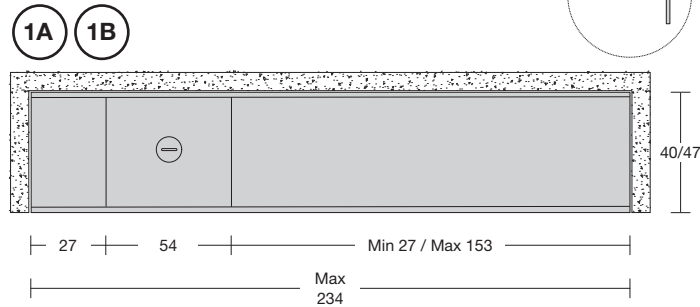
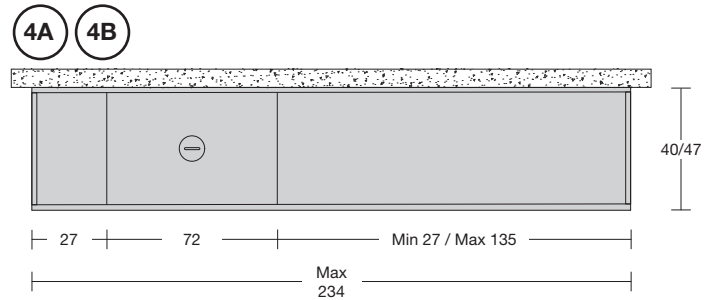
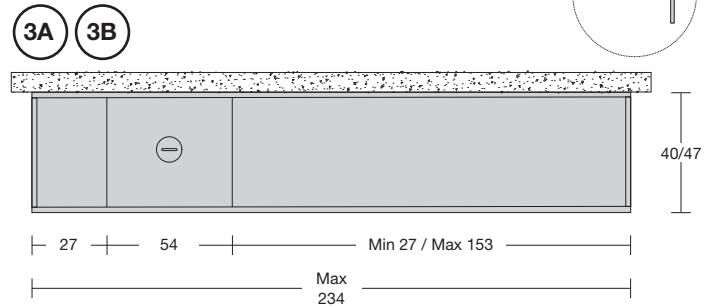
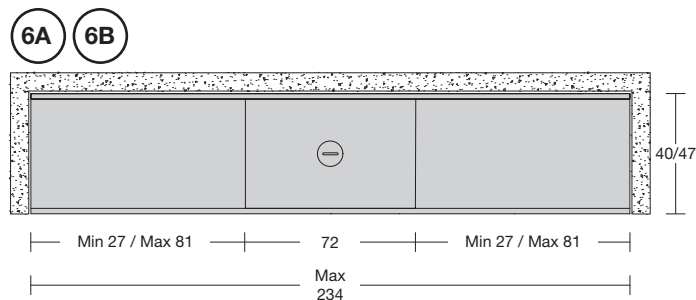
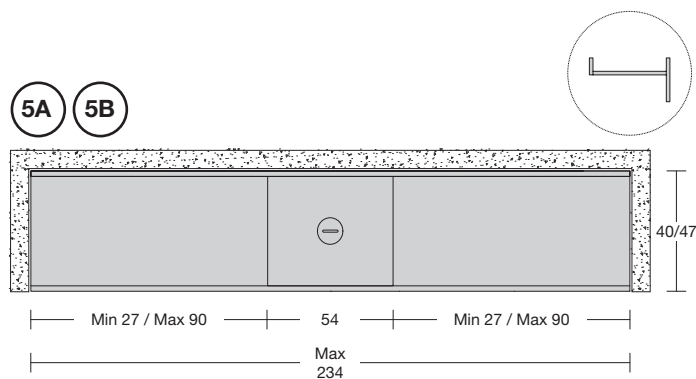
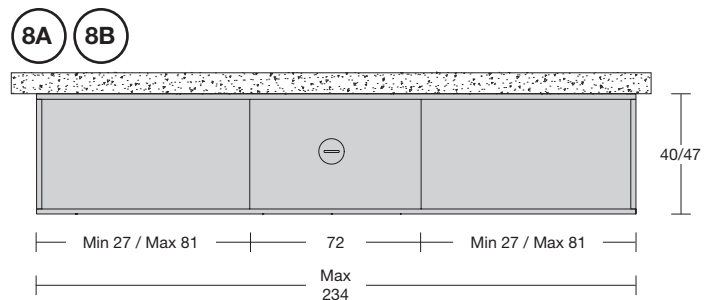
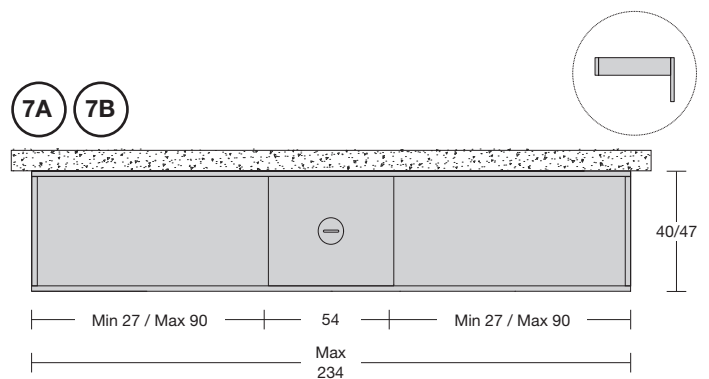
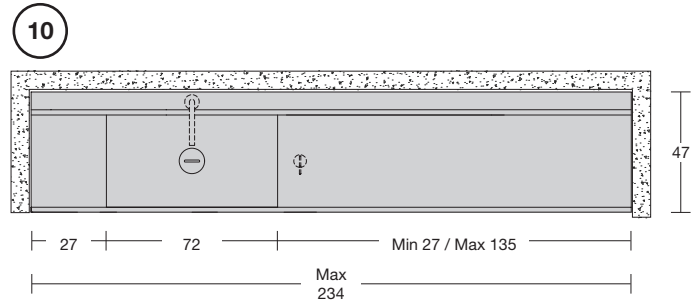
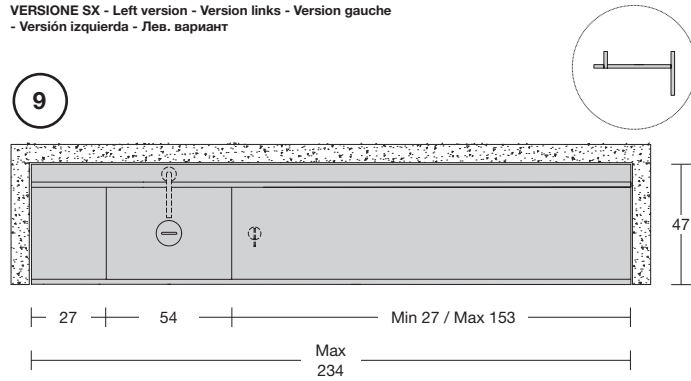
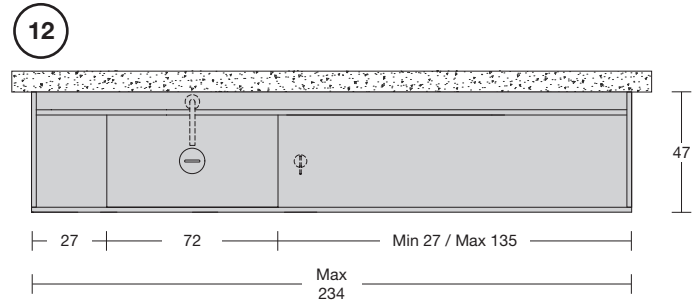
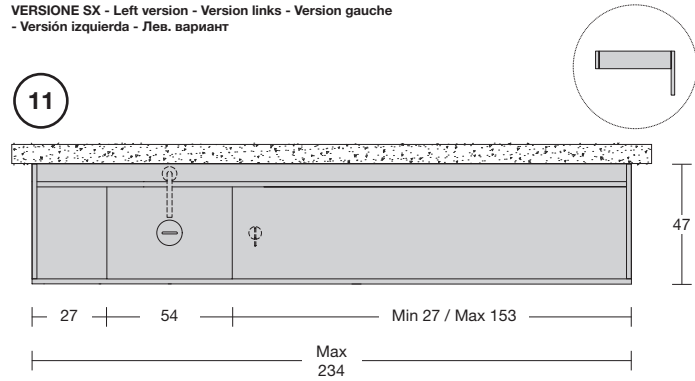
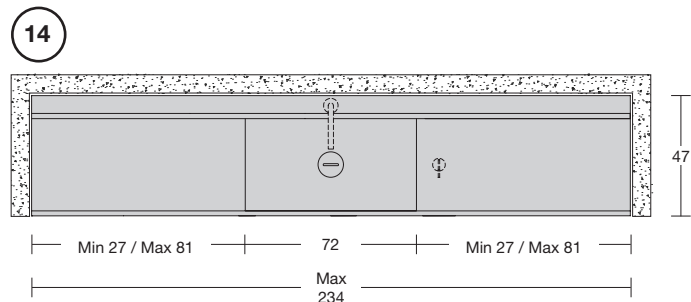
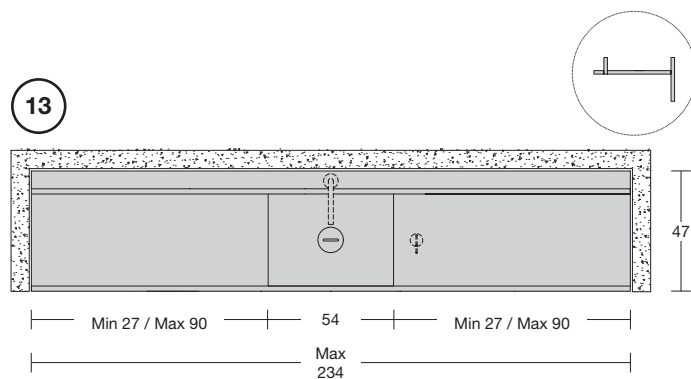
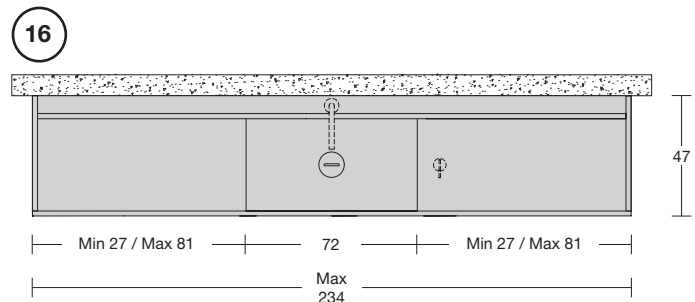
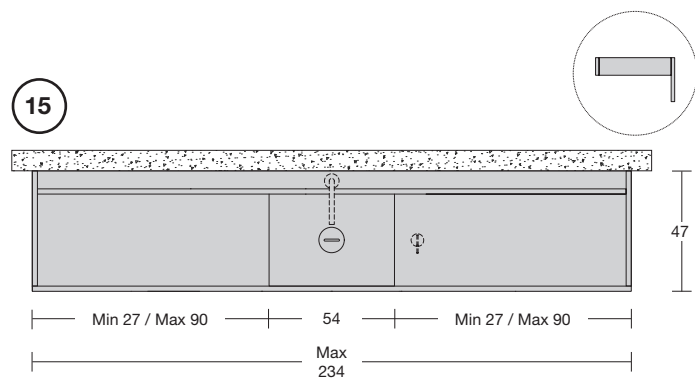

STREET consolle

**LAVABO DECENTRATO - OFF-CENTER SINK - EXZENTRISCHES BECKEN - LAVABO DÉCENTRÉ - LAVABO DESCENTRADO - ДЕЦЕНТРАЛИЗОВАННАЯ РАКОВИНА****IN NICCHIA - WITHIN WALLS - NISCHEINSTALLATION - EN NICHE  
-ENTRE PAREDES - В НИШУ**VERSIONE SX - Left version - Version links - Version gauche  
- Versión izquierda - Лев. вариант**A PARETE CON FIANCHI DI CHIUSURA - WALL MOUNTED WITH CLOSED SIDES  
- WANDINSTALLATION MIT SEITENWANGEN - INSTALLATION MURALE AVEC  
FLANCS DE FINITION - EN PARED CON COSTADOS TERMINALES - НАСТЕННЫЙ  
МОНТАЖ С БОРТИКАМИ ДЛЯ ЗАКРЫТИЯ**VERSIONE SX - Left version - Version links - Version gauche  
- Versión izquierda - Лев. вариант**LAVABO CENTRATO - CENTERED SINK - MITTIGES BECKEN - LAVABO CENTRÉ - LAVABO CENTRADO - РАКОВИНА ПО ЦЕНТРУ****IN NICCHIA - WITHIN WALLS - NISCHEINSTALLATION - EN NICHE  
-ENTRE PAREDES - В НИШУ****A PARETE CON FIANCHI DI CHIUSURA - WALL MOUNTED WITH CLOSED SIDES  
- WANDINSTALLATION MIT SEITENWANGEN - INSTALLATION MURALE AVEC  
FLANCS DE FINITION - EN PARED CON COSTADOS TERMINALES - НАСТЕННЫЙ  
МОНТАЖ С БОРТИКАМИ ДЛЯ ЗАКРЫТИЯ**

## STREET consolle

**LAVABO DECENTRATO CON CANALE - OFF-CENTER SINK WITH CANAL - EXZENTRISCHES BECKEN MIT RÜCKKANAL - LAVABO DÉCENTRÉ AVEC CANAL ARRIÈRE - LAVABO DESCENTRADO CON CANAL - ДЕЦЕНТРАЛИЗОВАННАЯ РАКОВИНА**
**IN NICCHIA - WITHIN WALLS - NISCHEINSTALLATION - EN NICHE  
-ENTRE PAREDES - В НИШУ**
**VERSIONE SX - Left version - Version links - Version gauche  
- Versión izquierda - Лев. вариант**

**A PARETE CON FIANCHI DI CHIUSURA - WALL MOUNTED WITH CLOSED SIDES  
- WANDINSTALLATION MIT SEITENWANGEN - INSTALLATION MURALE AVEC  
FLANCS DE FINITION - EN PARED CON COSTADOS TERMINALES - НАСТЕННЫЙ  
МОНТАЖ С БОРТИКАМИ ДЛЯ ЗАКРЫТИЯ**
**VERSIONE SX - Left version - Version links - Version gauche  
- Versión izquierda - Лев. вариант**

**LAVABO CENTRATO CON CANALE - CENTERED SINK WITH CANAL - MITTIGES BECKEN MIT RÜCKKANAL - LAVABO CENTRÉ AVEC CANAL ARRIÈRE - LAVABO CENTRADO CON CANAL - РАКОВИНА ПО ЦЕНТРУ С КАНАЛОМ**
**IN NICCHIA - WITHIN WALLS - NISCHEINSTALLATION - EN NICHE  
-ENTRE PAREDES - В НИШУ**

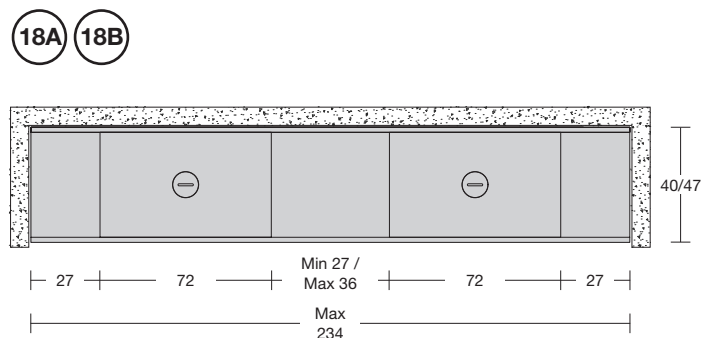
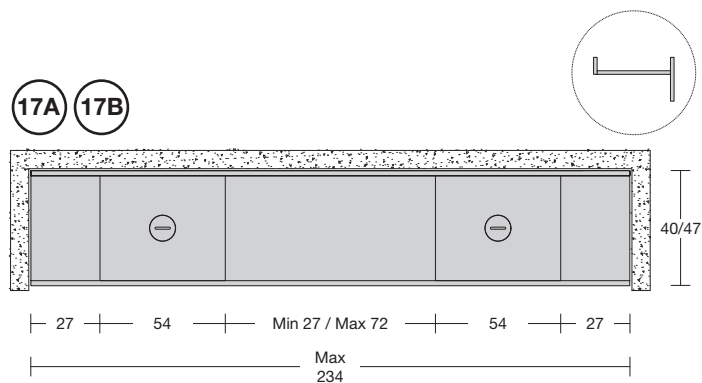
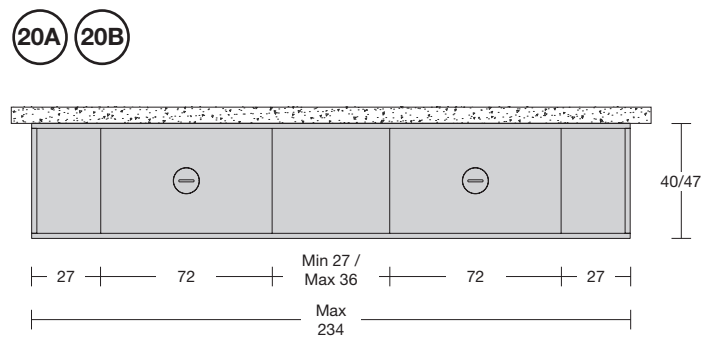
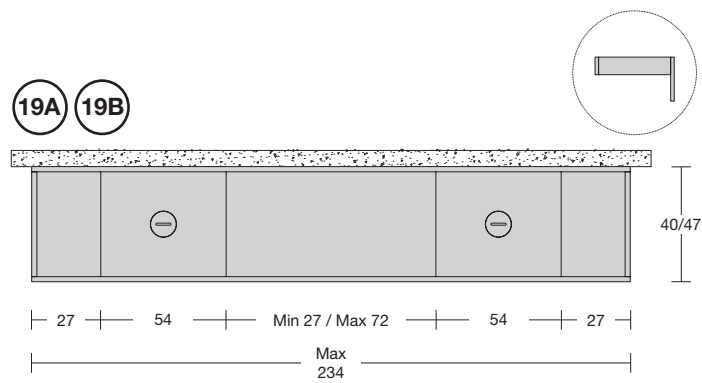
**A PARETE CON FIANCHI DI CHIUSURA - WALL MOUNTED WITH CLOSED SIDES  
- WANDINSTALLATION MIT SEITENWANGEN - INSTALLATION MURALE AVEC  
FLANCS DE FINITION - EN PARED CON COSTADOS TERMINALES - НАСТЕННЫЙ  
МОНТАЖ С БОРТИКАМИ ДЛЯ ЗАКРЫТИЯ**

STREET consolle

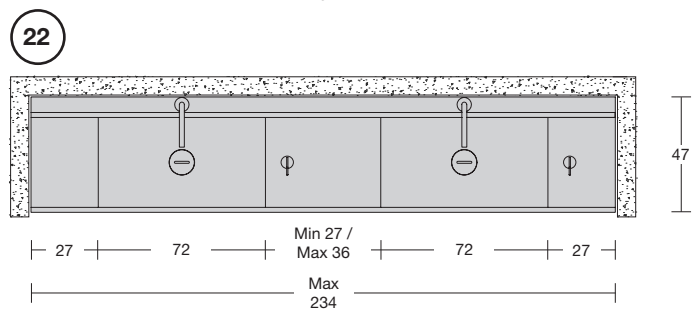
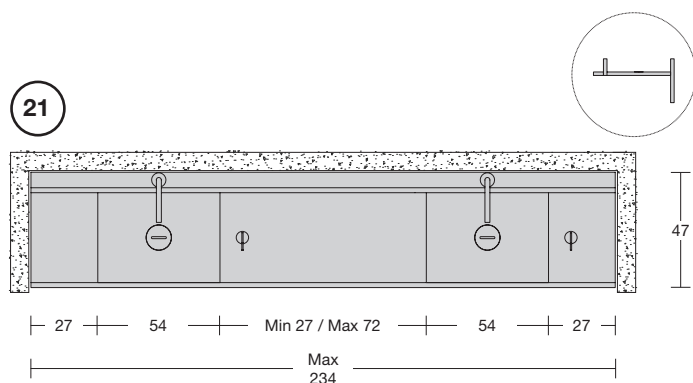
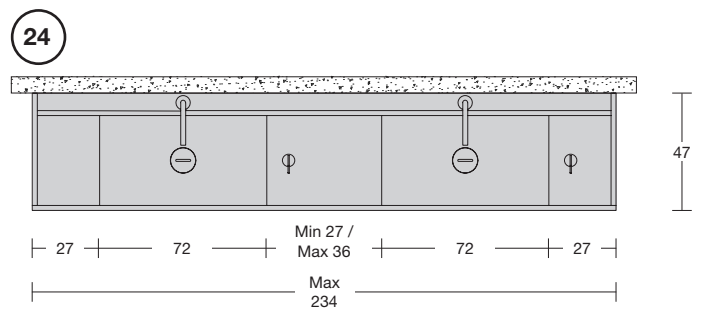
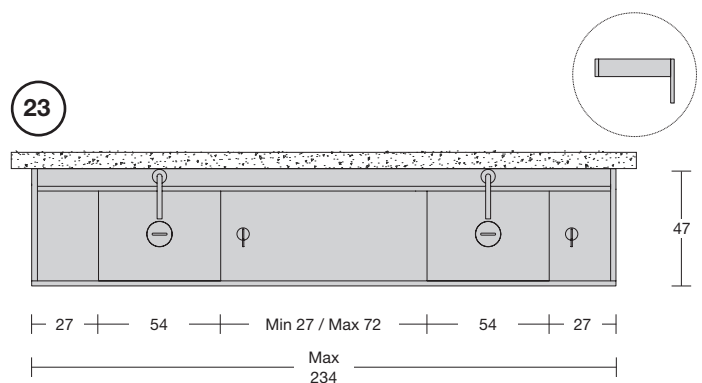
## LAVABO DOPPIO - DOUBLE SINK - DOPPELWASCHBECKEN - DOUBLE VASQUE - LAVABO DOBLE - ДВОЙНАЯ РАКОВИНА

IN NICCHIA - WITHIN WALLS - NISCHEINSTALLATION - EN NICHE  
-ENTRE PAREDES - В НИШУA PARETE CON FIANCHI DI CHIUSURA - WALL MOUNTED WITH CLOSED SIDES  
- WANDINSTALLATION MIT SEITENWANGEN - INSTALLATION MURALE AVEC  
FLANCS DE FINITION - EN PARED CON COSTADOS TERMINALES - НАСТЕННЫЙ  
МОНТАЖ С БОРТИКАМИ ДЛЯ ЗАКРЫТИЯ

## LAVABO DOPPIO CON CANALE - DOUBLE SINK WITH CANAL - DOPPELWASCHBECKEN MIT RÜCKKANAL - DOUBLE VASQUE AVEC CANAL ARRIÈRE - LAVABO DOBLE CON CANAL - ДВОЙНАЯ РАКОВИНА С КАНАЛОМ

IN NICCHIA - WITHIN WALLS - NISCHEINSTALLATION - EN NICHE  
-ENTRE PAREDES - В НИШУA PARETE CON FIANCHI DI CHIUSURA - WALL MOUNTED WITH CLOSED SIDES  
- WANDINSTALLATION MIT SEITENWANGEN - INSTALLATION MURALE AVEC  
FLANCS DE FINITION - EN PARED CON COSTADOS TERMINALES - НАСТЕННЫЙ  
МОНТАЖ С БОРТИКАМИ ДЛЯ ЗАКРЫТИЯ

## STREET Consolle

Articolo: **STREET240 prof. 40 + STREET4054 prof. 40**

Materiale: Marmo o Corian

Troppopieno: NO

**Descrizione:** Top con lavabo integrato in Marmo o Corian, con sistema di scarico predisposto per sifone. La versione in Corian presenta il sistema di piletta con troppopieno invisibile.

Article: **STREET240 prof. 40 + STREET4054 prof. 40**

Material: Marble or Corian

Overflow: NO

**Description:** Top with integrated sink in Marble or Corian, with drain prepared for siphon. The Corian version features the drain system with an invisible automatic overflow.

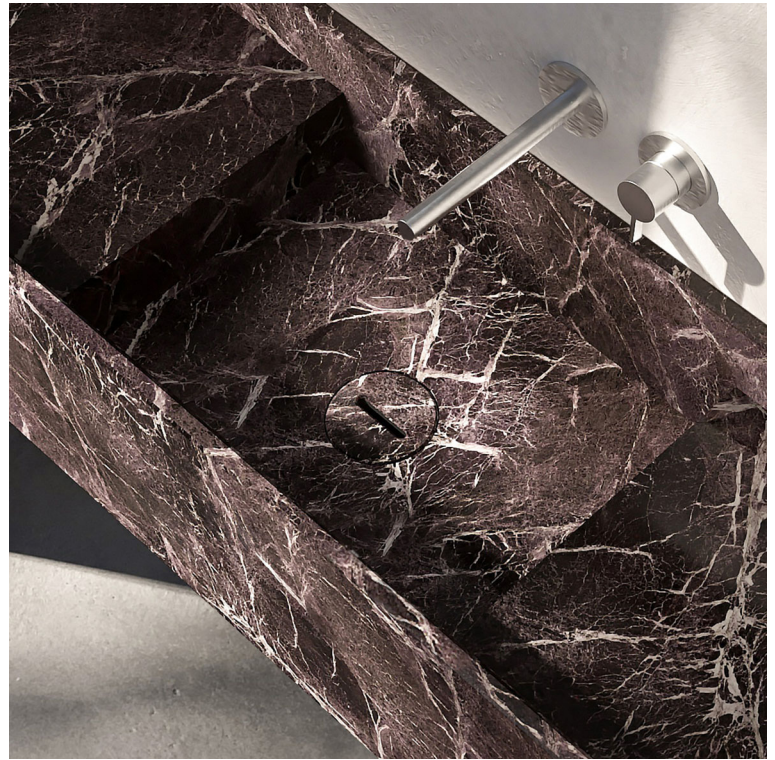

1A

**LAVABO DECENTRATO  
OFF CENTER SINK  
IN NICCHIA  
WITHIN WALLS**

**Marmo  
Marble**

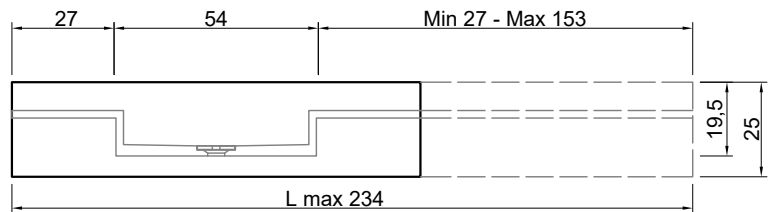

**Marmo  
Marble**

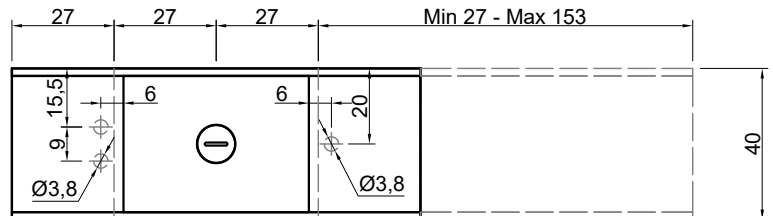

**Versione sinistra  
Left version**

**Corian  
Corian**

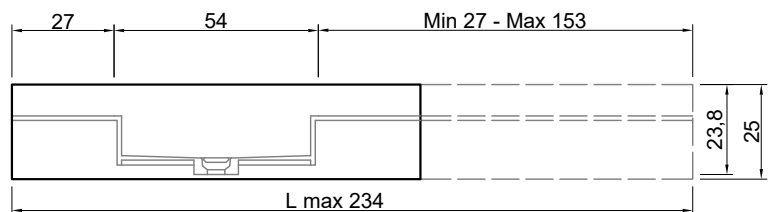

**Corian  
Corian**

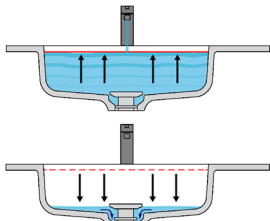
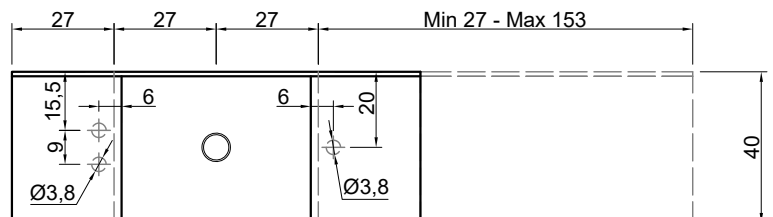

**Troppopieno automatico invisibile  
Valido solo per la versione in Corian**  
La piletta si apre automaticamente al raggiungimento del livello di sicurezza PREDEFINITO, permettendo all'acqua di defluire.

**Automatic invisible Overflow  
Valid only for the Corian version**  
The drain opens automatically when the PRESET safety level is reached allowing the water to drain away.



## STREET Consolle

Articolo: **STREET247 prof. 47 + STREET4754 prof. 47**

Materiale: Marmo o Corian

Troppopieno: NO

**Descrizione:** Top con lavabo integrato in Marmo o Corian, con sistema di scarico predisposto per sifone. La versione in Corian presenta il sistema di piletta con troppopieno invisibile.

Article: **STREET247 prof. 47 + STREET4754 prof. 47**

Material: Marble or Corian

Overflow: NO

**Description:** Top with integrated sink in Marble or Corian, with drain prepared for siphon. The Corian version features the drain system with an invisible automatic overflow.



1B

**LAVABO DECENTRATO  
OFF CENTER SINK  
IN NICCHIA  
WITHIN WALLS**

**Marmo  
Marble**

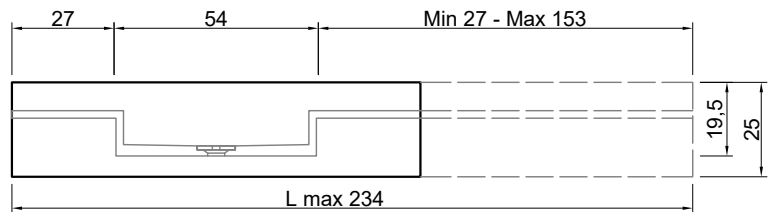

**Marmo  
Marble**

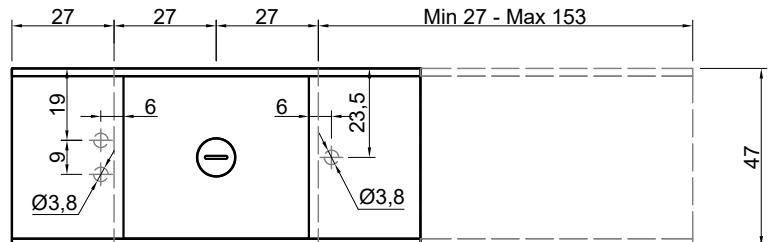

**Versione sinistra  
Left version**

**Corian  
Corian**

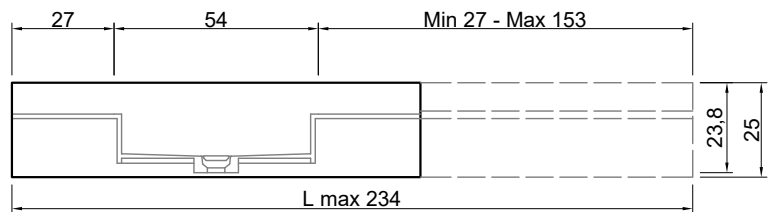

**Corian  
Corian**

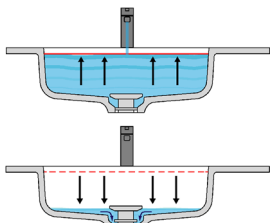
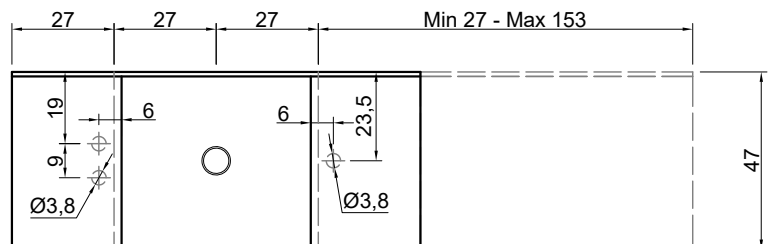

**Troppopieno automatico invisibile  
Valido solo per la versione in Corian**  
La piletta si apre automaticamente al raggiungimento del livello di sicurezza PREDEFINITO, permettendo all'acqua di defluire.

**Automatic invisible Overflow  
Valid only for the Corian version**  
The drain opens automatically when the PRESET safety level is reached allowing the water to drain away.

## STREET Consolle

Articolo: **STREET240 prof. 40 + STREET4072 prof. 40**

Materiale: Marmo o Corian

Troppopieno: NO

**Descrizione:** Top con lavabo integrato in Marmo o Corian, con sistema di scarico predisposto per sifone. La versione in Corian presenta il sistema di piletta con troppopieno invisibile.

Article: **STREET240 prof. 40 + STREET4072 prof. 40**

Material: Marble or Corian

Overflow: NO

**Description:** Top with integrated sink in Marble or Corian, with drain prepared for siphon. The Corian version features the drain system with an invisible automatic overflow.



2A

**LAVABO DECENTRATO  
OFF CENTER SINK  
IN NICCHIA  
WITHIN WALLS**

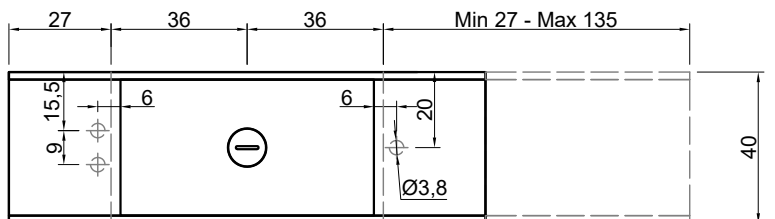
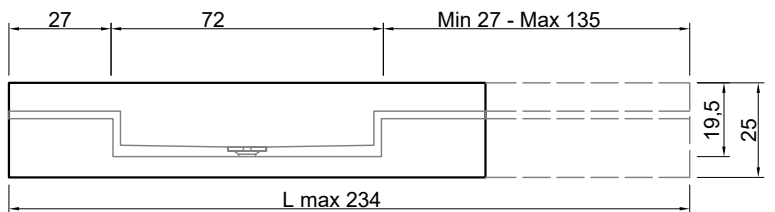

**Versione sinistra  
Left version**

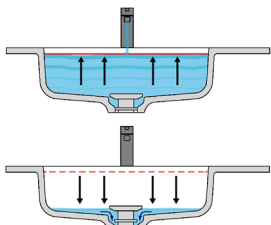
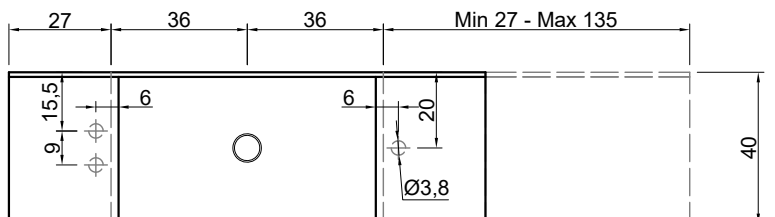
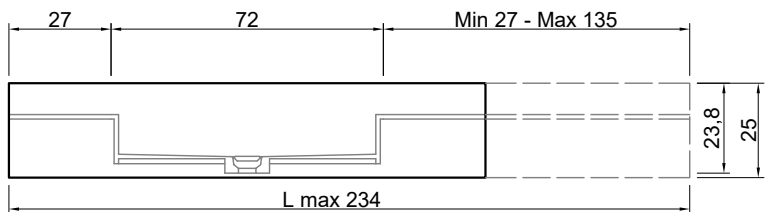

**Troppopieno automatico invisibile  
Valido solo per la versione in Corian**  
La piletta si apre automaticamente al raggiungimento del livello di sicurezza PREDEFINITO, permettendo all'acqua di defluire.

**Automatic invisible Overflow  
Valid only for the Corian version**  
The drain opens automatically when the PRESET safety level is reached allowing the water to drain away.



## STREET Consolle

Articolo: **STREET247 prof. 47** + **STREET4772 prof. 47**

Materiale: Marmo o Corian

Troppopieno: NO

**Descrizione:** Top con lavabo integrato in Marmo o Corian, con sistema di scarico predisposto per sifone. La versione in Corian presenta il sistema di piletta con troppopieno invisibile.

Article: **STREET247 prof. 47** + **STREET4772 prof. 47**

Material: Marble or Corian

Overflow: NO

**Description:** Top with integrated sink in Marble or Corian, with drain prepared for siphon. The Corian version features the drain system with an invisible automatic overflow.

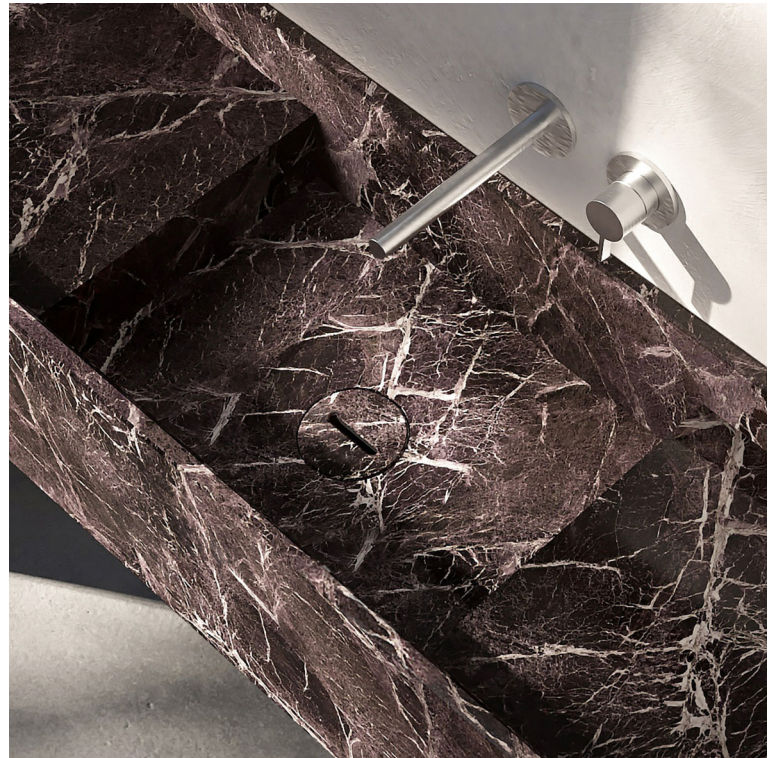

2B

**LAVABO DECENTRATO  
OFF CENTER SINK  
IN NICCHIA  
WITHIN WALLS**

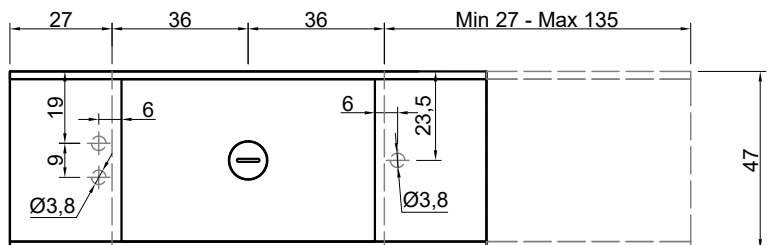
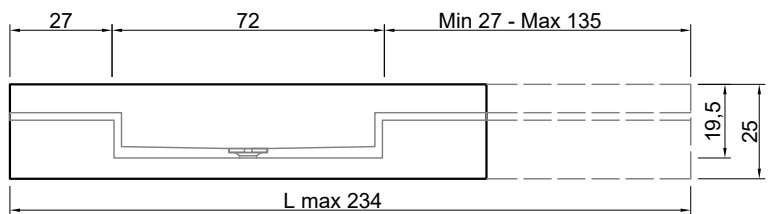

**Versione sinistra  
Left version**

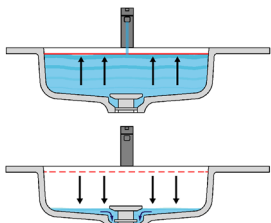
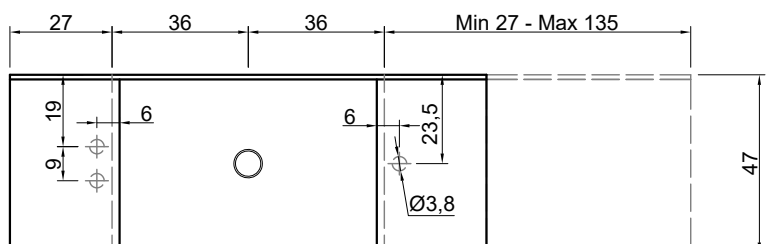
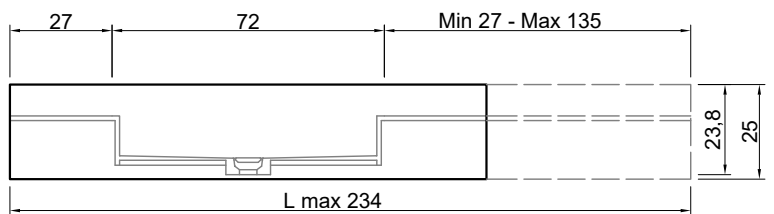

**Troppopieno automatico invisibile  
Valido solo per la versione in Corian**  
La piletta si apre automaticamente al raggiungimento del livello di sicurezza PREDEFINITO, permettendo all'acqua di defluire.

**Automatic invisible Overflow  
Valid only for the Corian version**  
The drain opens automatically when the PRESET safety level is reached allowing the water to drain away.

## STREET Consolle

Articolo: **STREET140 prof. 40 + STREET4054 prof. 40**

Materiale: Marmo o Corian

Troppopieno: NO

**Descrizione:** Top con lavabo integrato in Marmo o Corian, con sistema di scarico predisposto per sifone. La versione in Corian presenta il sistema di piletta con troppopieno invisibile.

Article: **STREET140 prof. 40 + STREET4054 prof. 40**

Material: Marble or Corian

Overflow: NO

**Description:** Top with integrated sink in Marble or Corian, with drain prepared for siphon. The Corian version features the drain system with an invisible automatic overflow.



3A

**LAVABO DECENTRATO  
OFF CENTER SINK  
A PARETE CON FIANCHI DI CHIUSURA  
WALL MOUNTED WITH CLOSED SIDES**

**Marmo  
Marble**

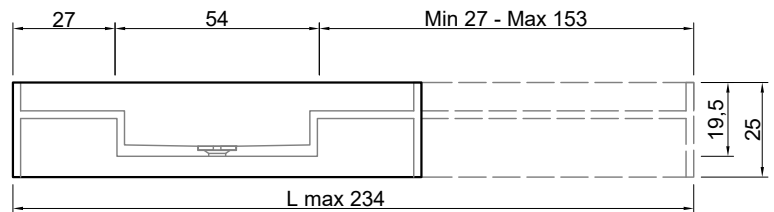

**Marmo  
Marble**

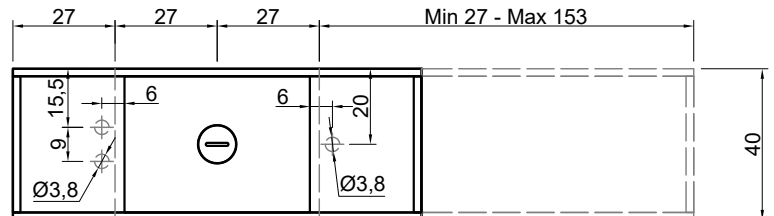

**Versione sinistra  
Left version**

**Corian  
Corian**

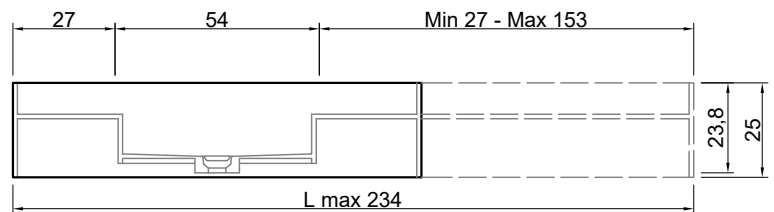

**Corian  
Corian**

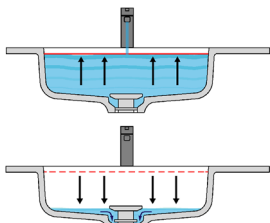
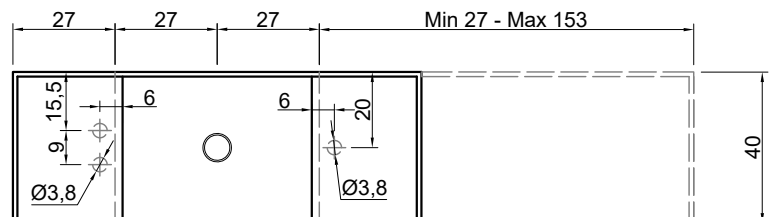

**Troppopieno automatico invisibile  
Valido solo per la versione in Corian**  
La piletta si apre automaticamente al raggiungimento del livello di sicurezza PREDEFINITO, permettendo all'acqua di defluire.

**Automatic invisible Overflow  
Valid only for the Corian version**  
The drain opens automatically when the PRESET safety level is reached allowing the water to drain away.



## STREET Consolle

Articolo: **STREET147 prof. 47 + STREET4754 prof. 47**

Materiale: Marmo o Corian

Troppopieno: NO

**Descrizione:** Top con lavabo integrato in Marmo o Corian, con sistema di scarico predisposto per sifone. La versione in Corian presenta il sistema di piletta con troppopieno invisibile.

Article: **STREET147 prof. 47 + STREET4754 prof. 47**

Material: Marble or Corian

Overflow: NO

**Description:** Top with integrated sink in Marble or Corian, with drain prepared for siphon. The Corian version features the drain system with an invisible automatic overflow.

3B

**LAVABO DECENTRATO  
OFF CENTER SINK  
A PARETE CON FIANCHI DI CHIUSURA  
WALL MOUNTED WITH CLOSED SIDES**

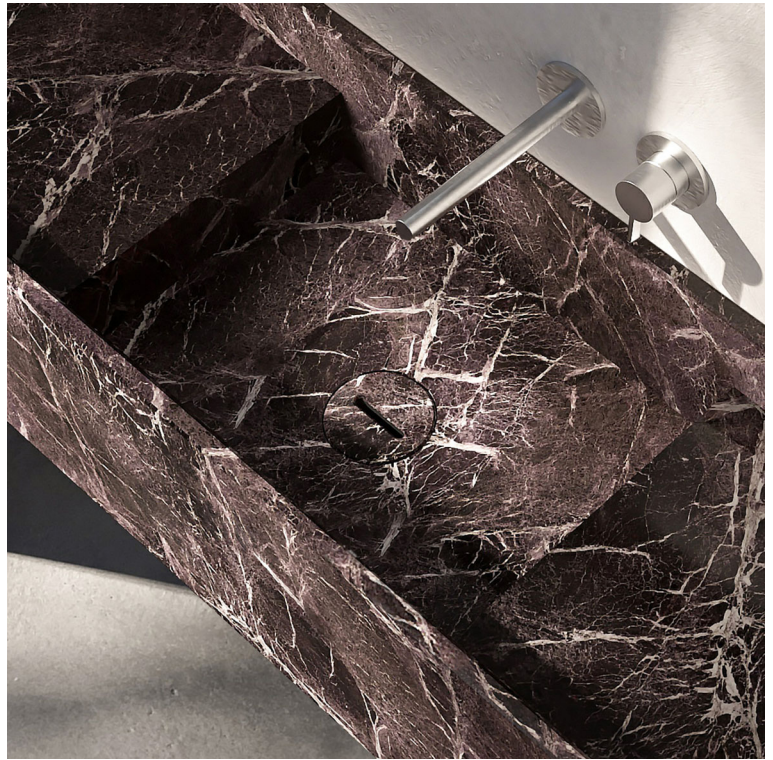

**Marmo  
Marble**

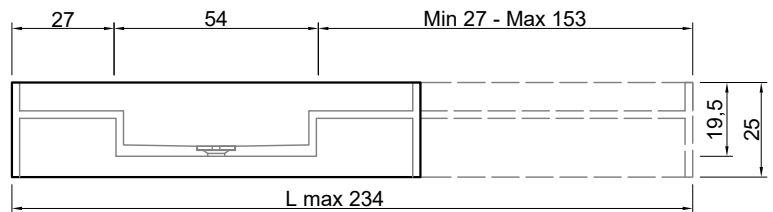

**Marmo  
Marble**

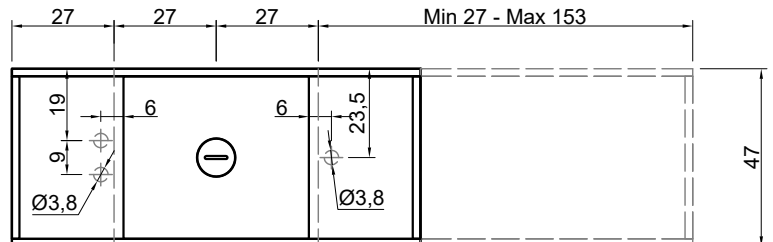

**Versione sinistra  
Left version**

**Corian  
Corian**

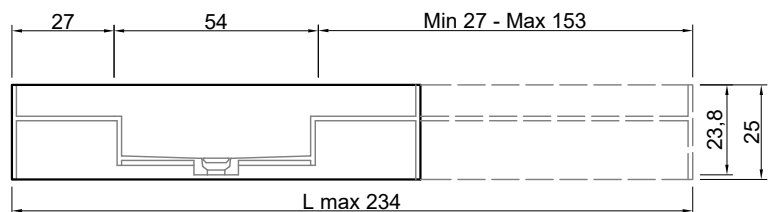

**Corian  
Corian**

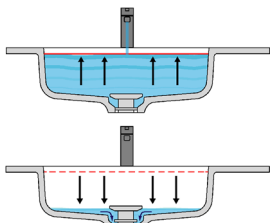
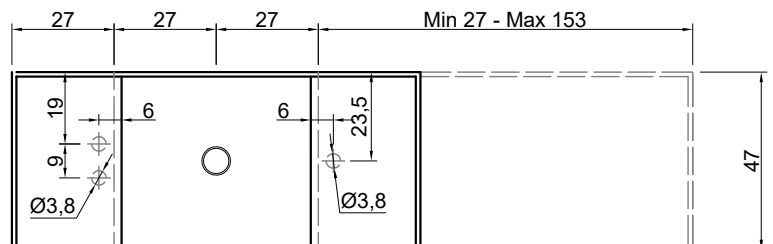

**Troppopieno automatico invisibile  
Valido solo per la versione in Corian**  
La piletta si apre automaticamente al raggiungimento del livello di sicurezza PREDEFINITO, permettendo all'acqua di defluire.

**Automatic invisible Overflow  
Valid only for the Corian version**  
The drain opens automatically when the PRESET safety level is reached allowing the water to drain away.

## STREET Consolle

Articolo: **STREET140 prof. 40 + STREET4072 prof. 40**

Materiale: Marmo o Corian

Trooppieno: NO

**Descrizione:** Top con lavabo integrato in Marmo o Corian, con sistema di scarico predisposto per sifone. La versione in Corian presenta il sistema di piletta con trooppieno invisibile.

Article: **STREET140 prof. 40 + STREET4072 prof. 40**

Material: Marble or Corian

Overflow: NO

**Description:** Top with integrated sink in Marble or Corian, with drain prepared for siphon. The Corian version features the drain system with an invisible automatic overflow.



4A

**LAVABO DECENTRATO  
OFF CENTER SINK  
A PARETE CON FIANCHI DI CHIUSURA  
WALL MOUNTED WITH CLOSED SIDES**

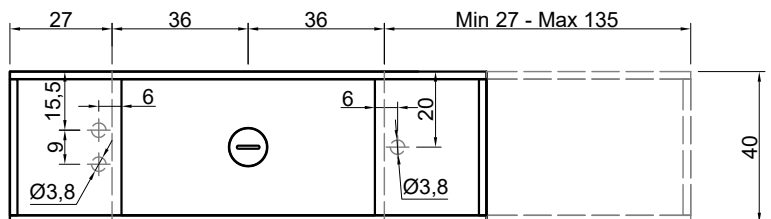
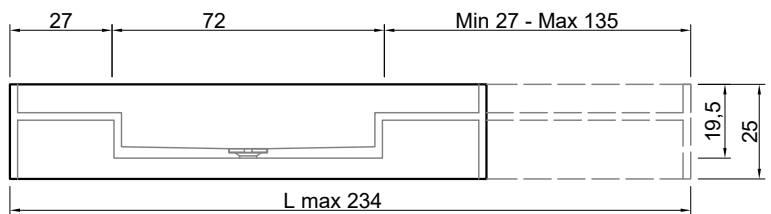

**Versione sinistra  
Left version**

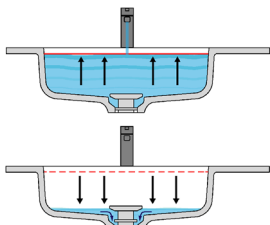
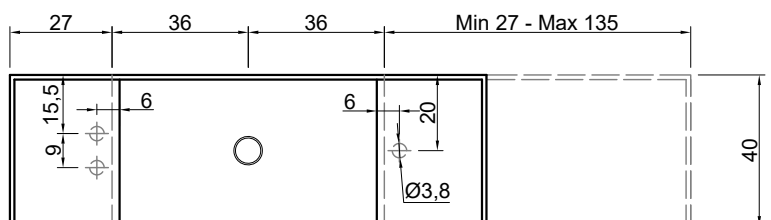
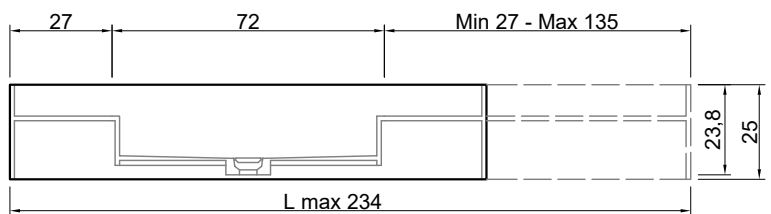

**Trooppieno automatico invisibile  
Valido solo per la versione in Corian**  
La piletta si apre automaticamente al raggiungimento del livello di sicurezza PREDEFINITO, permettendo all'acqua di defluire.

**Automatic invisible Overflow  
Valid only for the Corian version**  
The drain opens automatically when the PRESET safety level is reached allowing the water to drain away.



## STREET Consolle

Articolo: **STREET147 prof. 47 + STREET4772 prof. 47**

Materiale: Marmo o Corian

Trooppieno: NO

**Descrizione:** Top con lavabo integrato in o Corian, con sistema di scarico predisposto per sifone. La versione in Corian presenta il sistema di piletta con trooppieno invisibile.

Article: **STREET147 prof. 47 + STREET4772 prof. 47**

Material: Marble or Corian

Overflow: NO

**Description:** Top with integrated sink in Marble or Corian, with drain prepared for siphon. The Corian version features the drain system with an invisible automatic overflow.

4B

**LAVABO DECENTRATO  
OFF CENTER SINK  
A PARETE CON FIANCHI DI CHIUSURA  
WALL MOUNTED WITH CLOSED SIDES**

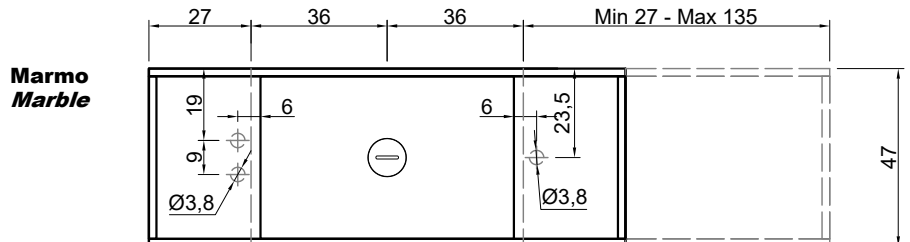
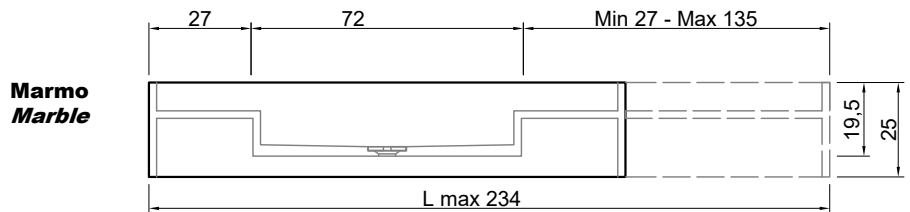
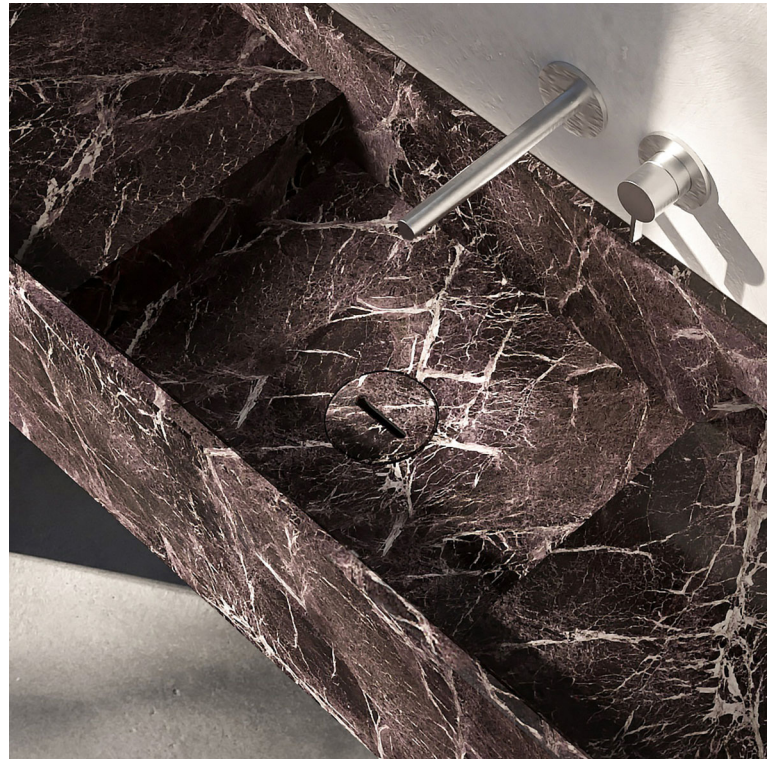

**Versione sinistra  
Left version**

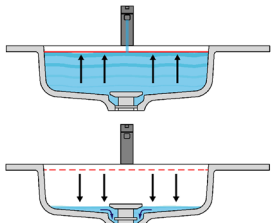
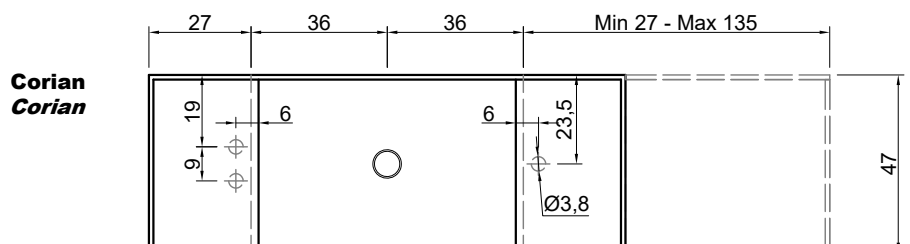
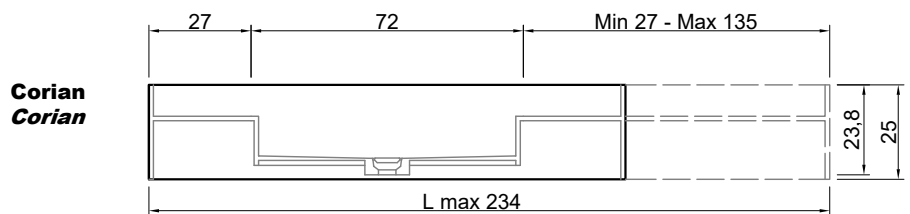

**Trooppieno automatico invisibile  
Valido solo per la versione in Corian**  
La piletta si apre automaticamente al raggiungimento del livello di sicurezza PREDEFINITO, permettendo all'acqua di defluire.

**Automatic invisible Overflow  
Valid only for the Corian version**  
The drain opens automatically when the PRESET safety level is reached allowing the water to drain away.



## STREET Consolle

Articolo: **STREET240 prof. 40 + STREET4054 prof. 40**

Materiale: Marmo o Corian

Troppopieno: NO

**Descrizione:** Top con lavabo integrato in Marmo o Corian, con sistema di scarico predisposto per sifone. La versione in Corian presenta il sistema di piletta con troppopieno invisibile.

Article: **STREET240 prof. 40 + STREET4054 prof. 40**

Material: Marble or Corian

Overflow: NO

**Description:** Top with integrated sink in Marble or Corian, with drain prepared for siphon. The Corian version features the drain system with an invisible automatic overflow.

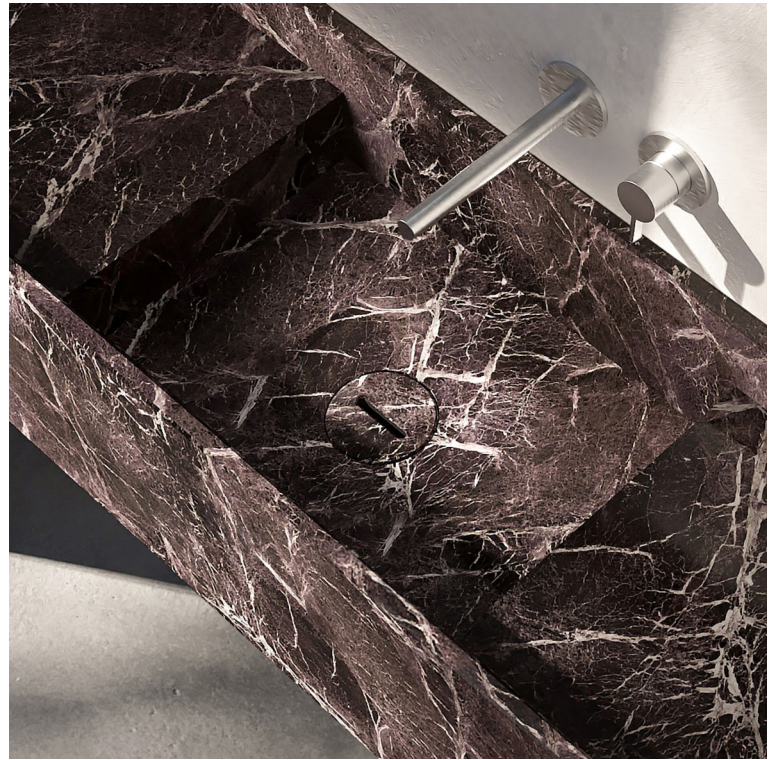

5A

**LAVABO DECENTRATO  
OFF CENTER SINK  
IN NICCHIA  
WITHIN WALLS**

**Marmo  
Marble**

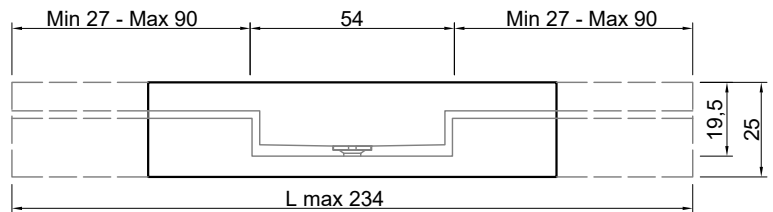

**Marmo  
Marble**

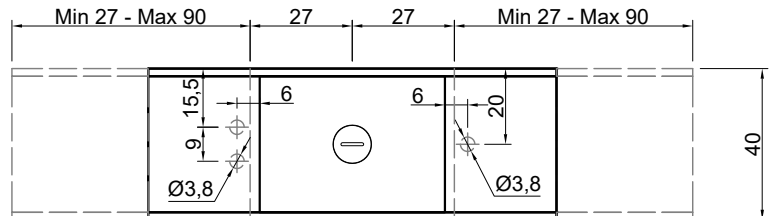

**Corian  
Corian**

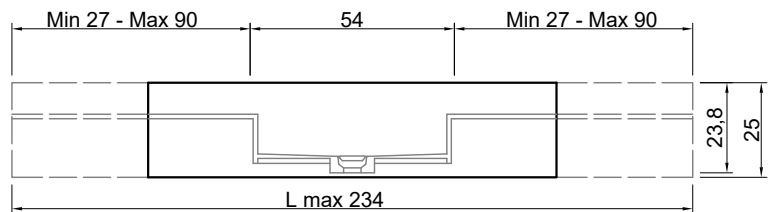

**Corian  
Corian**

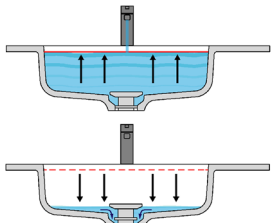
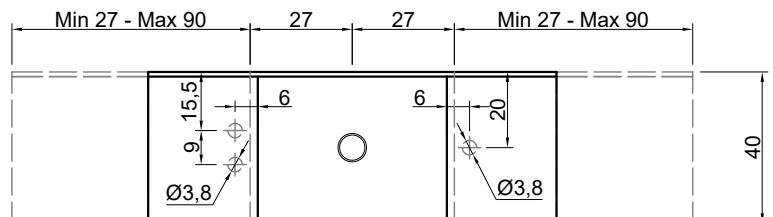

**Troppopieno automatico invisibile  
Valido solo per la versione in Corian**  
La piletta si apre automaticamente al raggiungimento del livello di sicurezza PREDEFINITO, permettendo all'acqua di defluire.

**Automatic invisible Overflow  
Valid only for the Corian version**  
The drain opens automatically when the PRESET safety level is reached allowing the water to drain away.

## STREET Consolle

Articolo: **STREET247 prof. 47** + **STREET4754 prof. 47**

Materiale: Marmo o Corian

Troppopieno: NO

**Descrizione:** Top con lavabo integrato in Marmo o Corian, con sistema di scarico predisposto per sifone. La versione in Corian presenta il sistema di piletta con troppopieno invisibile.

Article: **STREET247 prof. 47** + **STREET4754 prof. 47**

Material: Marble or Corian

Overflow: NO

**Description:** Top with integrated sink in Marble or Corian, with drain prepared for siphon. The Corian version features the drain system with an invisible automatic overflow.

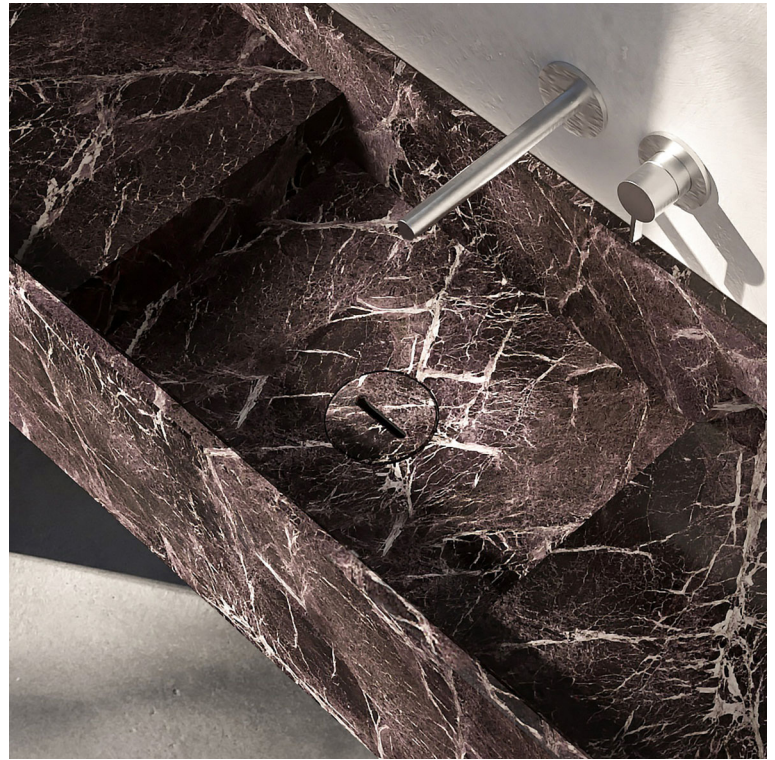

5B

**LAVABO CENTRATO  
CENTERED SINK  
IN NICCHIA  
WITHIN WALLS**

**Marmo  
Marble**

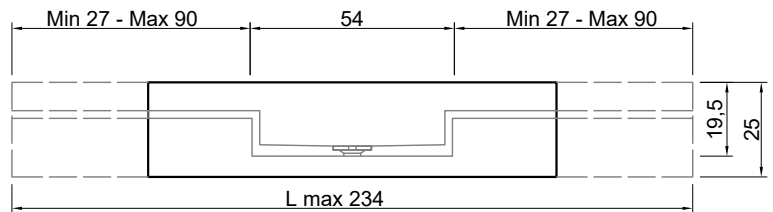

**Marmo  
Marble**

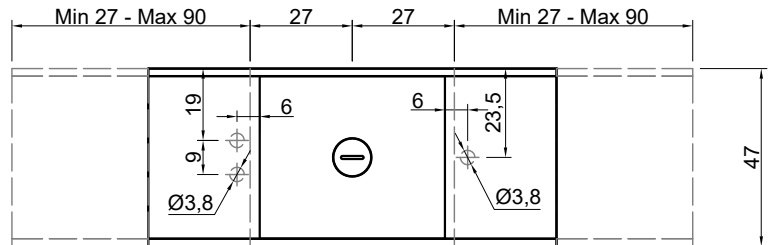

**Corian  
Corian**

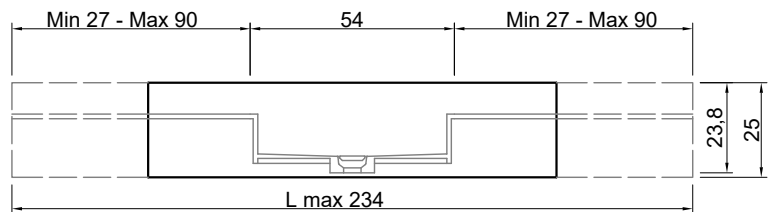

**Corian  
Corian**

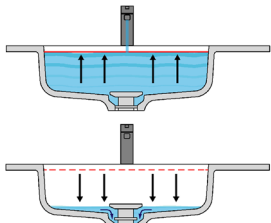
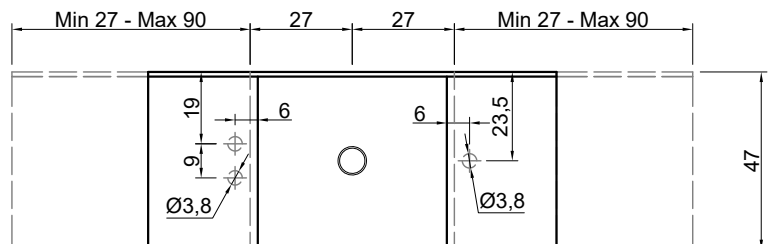

**Troppopieno automatico invisibile  
Valido solo per la versione in Corian**  
La piletta si apre automaticamente al raggiungimento del livello di sicurezza PREDEFINITO, permettendo all'acqua di defluire.

**Automatic invisible Overflow  
Valid only for the Corian version**  
The drain opens automatically when the PRESET safety level is reached allowing the water to drain away.



## STREET Consolle

Articolo: **STREET240 prof. 40 + STREET4072 prof. 40**

Materiale: Marmo o Corian

Troppopieno: NO

**Descrizione:** Top con lavabo integrato in Marmo o Corian, con sistema di scarico predisposto per sifone. La versione in Corian presenta il sistema di piletta con troppopieno invisibile.

Article: **STREET240 prof. 40 + STREET4072 prof. 40**

Material: Marble or Corian

Overflow: NO

**Description:** Top with integrated sink in Marble or Corian, with drain prepared for siphon. The Corian version features the drain system with an invisible automatic overflow.

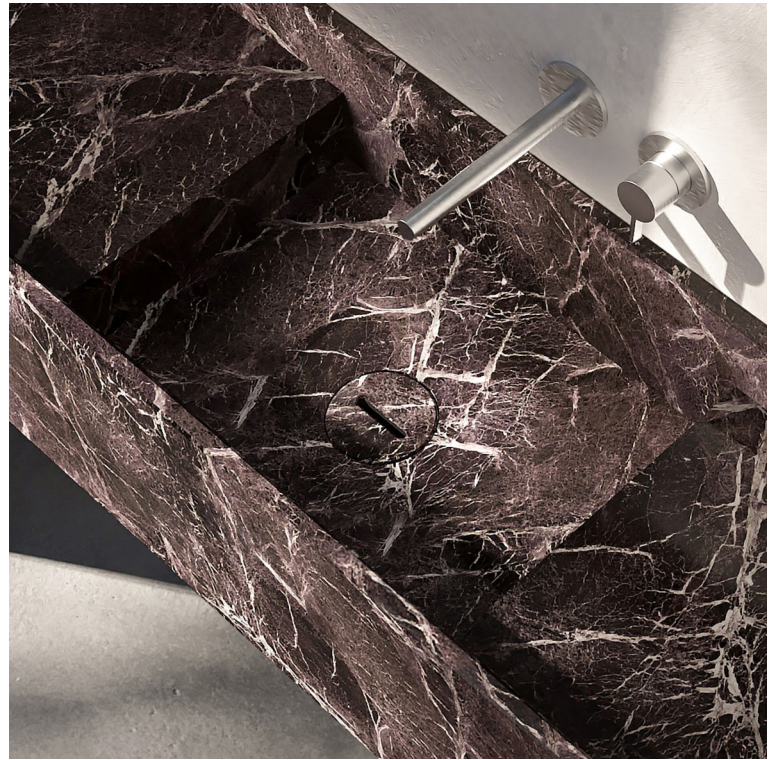

**6A** LAVABO CENTRATO  
CENTERED SINK  
IN NICCHIA  
WITHIN WALLS

**Marmo  
Marble**

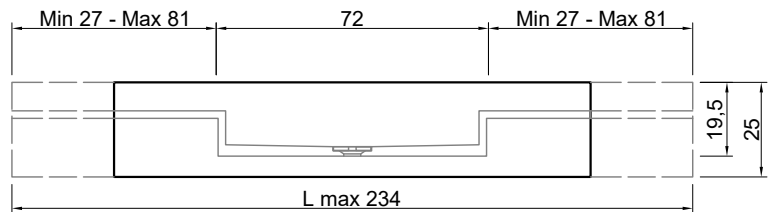

**Marmo  
Marble**

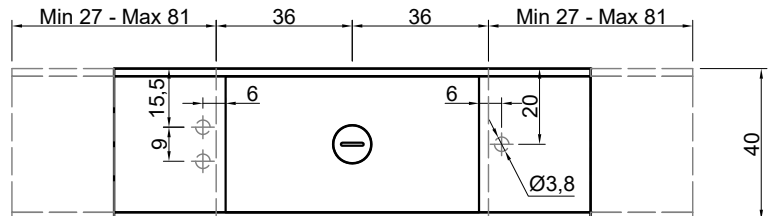

**Corian  
Corian**

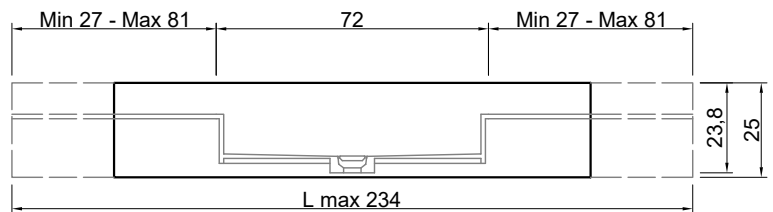

**Corian  
Corian**

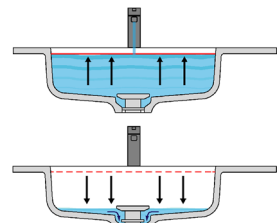
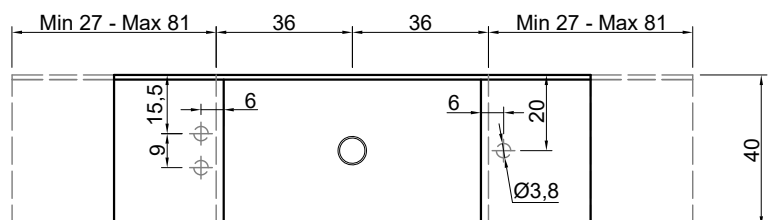

**Troppopieno automatico invisibile**  
Valido solo per la versione in Corian  
La piletta si apre automaticamente al raggiungimento del livello di sicurezza PREDEFINITO, permettendo all'acqua di defluire.

**Automatic invisible Overflow**  
Valid only for the Corian version  
The drain opens automatically when the PRESET safety level is reached allowing the water to drain away.



## STREET Consolle

Articolo: **STREET247 prof. 47 + STREET4772 prof. 47**

Materiale: Marmo o Corian

Troppopieno: NO

**Descrizione:** Top con lavabo integrato in Marmo o Corian, con sistema di scarico predisposto per sifone. La versione in Corian presenta il sistema di piletta con troppopieno invisibile.

Article: **STREET247 prof. 47 + STREET4772 prof. 47**

Material: Marble or Corian

Overflow: NO

**Description:** Top with integrated sink in Marble or Corian, with drain prepared for siphon. The Corian version features the drain system with an invisible automatic overflow.

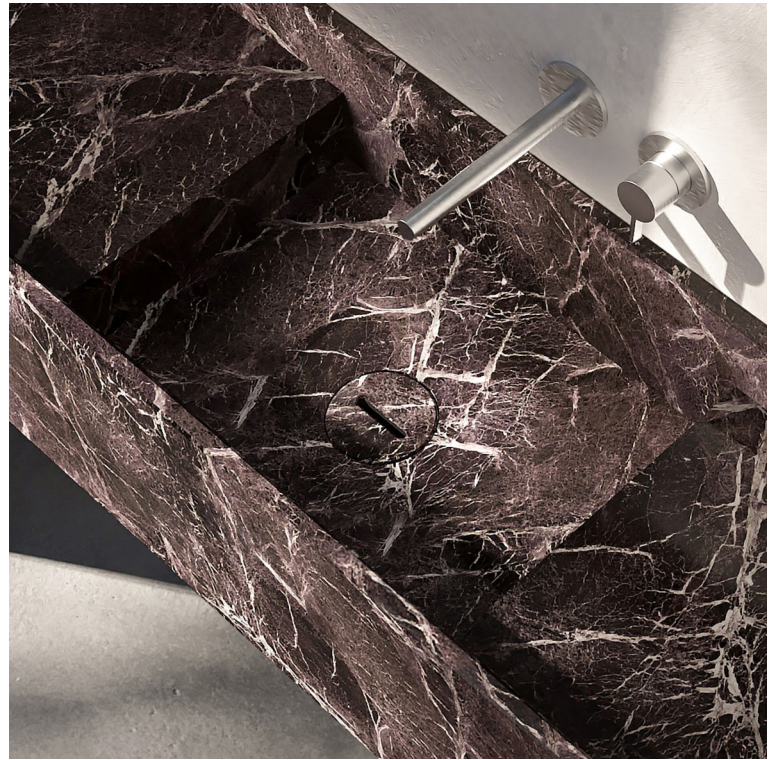

**6B** LAVABO CENTRATO  
CENTERED SINK  
IN NICCHIA  
WITHIN WALLS

**Marmo  
Marble**

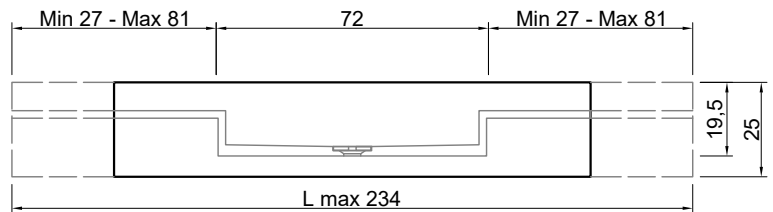

**Marmo  
Marble**

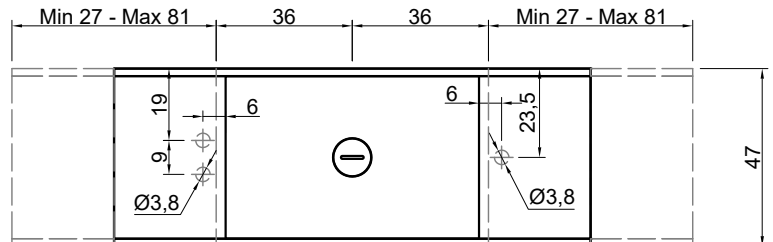

**Corian  
Corian**

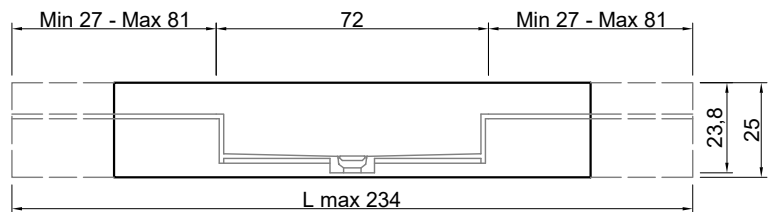

**Corian  
Corian**

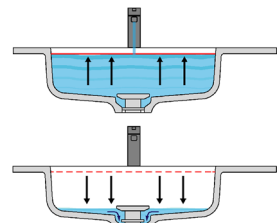
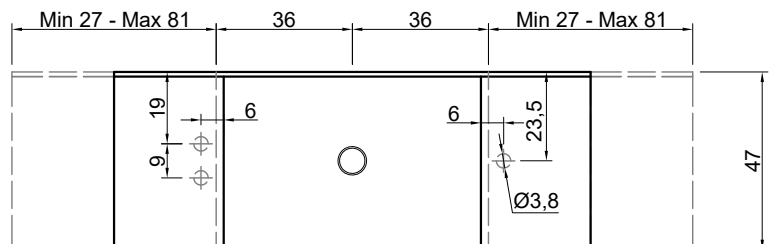

**Troppopieno automatico invisibile**  
Valido solo per la versione in Corian  
La piletta si apre automaticamente al raggiungimento del livello di sicurezza PREDEFINITO, permettendo all'acqua di defluire.

**Automatic invisible Overflow**  
Valid only for the Corian version  
The drain opens automatically when the PRESET safety level is reached allowing the water to drain away.

## STREET Consolle

Articolo: **STREET140 prof. 40 + STREET4054 prof. 40**

Materiale: Marmo o Corian

Trooppieno: NO

**Descrizione:** Top con lavabo integrato in Marmo o Corian, con sistema di scarico predisposto per sifone. La versione in Corian presenta il sistema di piletta con trooppieno invisibile.

Article: **STREET140 prof. 40 + STREET4054 prof. 40**

Material: Marble or Corian

Overflow: NO

**Description:** Top with integrated sink in Marble or Corian, with drain prepared for siphon. The Corian version features the drain system with an invisible automatic overflow.

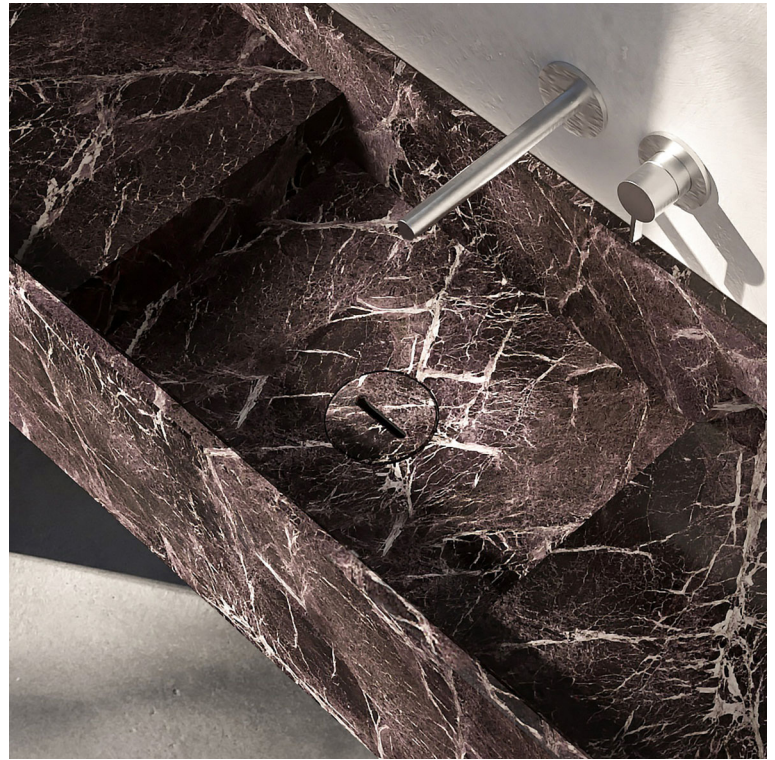

7A

**LAVABO CENTRATO  
CENTERED SINK  
A PARETE CON FIANCHI DI CHIUSURA  
WALL MOUNTED WITH CLOSED SIDES**

**Marmo  
Marble**

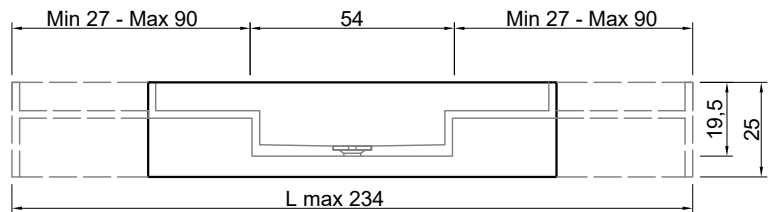

**Marmo  
Marble**

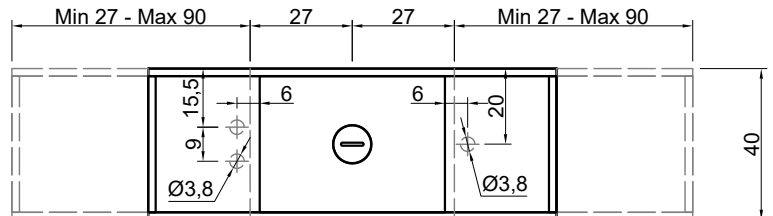

**Corian  
Corian**

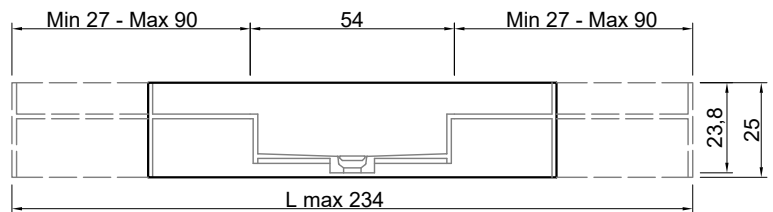

**Corian  
Corian**

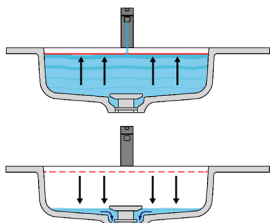
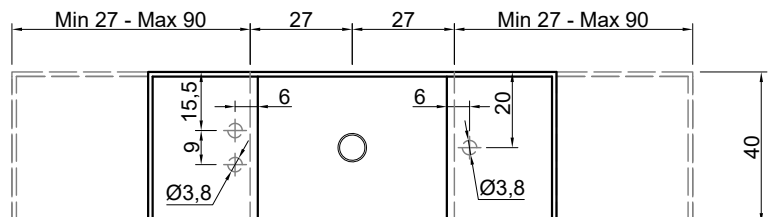

**Trooppieno automatico invisibile  
Valido solo per la versione in Corian**  
La piletta si apre automaticamente al raggiungimento del livello di sicurezza PREDEFINITO, permettendo all'acqua di defluire.

**Automatic invisible Overflow  
Valid only for the Corian version**  
The drain opens automatically when the PRESET safety level is reached allowing the water to drain away.



## STREET Consolle

Articolo: **STREET147 prof. 47 + STREET4754 prof. 47**

Materiale: Marmo o Corian

Troppopieno: NO

**Descrizione:** Top con lavabo integrato in Marmo o Corian, con sistema di scarico predisposto per sifone. La versione in Corian presenta il sistema di piletta con troppopieno invisibile.

Article: **STREET147 prof. 47 + STREET4754 prof. 47**

Material: Marble or Corian

Overflow: NO

**Description:** Top with integrated sink in Marble or Corian, with drain prepared for siphon. The Corian version features the drain system with an invisible automatic overflow. The Corian version features the drain system with an invisible automatic overflow.



7B

**LAVABO CENTRATO  
CENTERED SINK  
A PARETE CON FIANCHI DI CHIUSURA  
WALL MOUNTED WITH CLOSED SIDES**

**Marmo  
Marble**

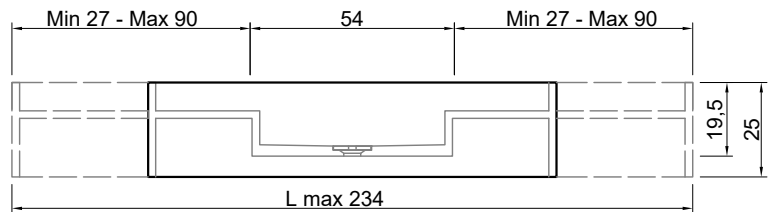

**Marmo  
Marble**

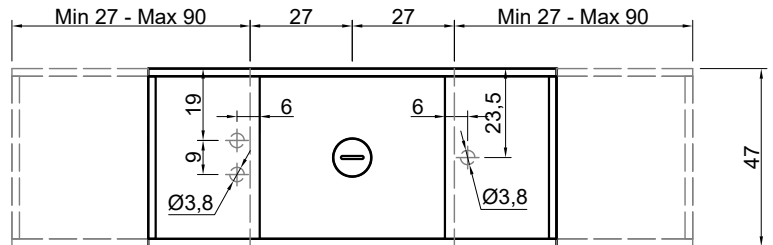

**Corian  
Corian**

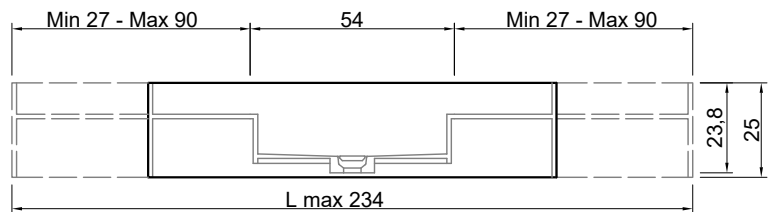

**Corian  
Corian**

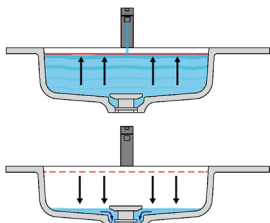
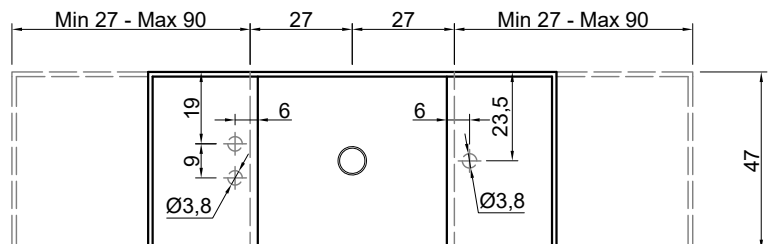

**Troppopieno automatico invisibile  
Valido solo per la versione in Corian**  
La piletta si apre automaticamente al raggiungimento del livello di sicurezza PREDEFINITO, permettendo all'acqua di defluire.

**Automatic invisible Overflow  
Valid only for the Corian version**  
The drain opens automatically when the PRESET safety level is reached allowing the water to drain away.



## STREET Consolle

Articolo: **STREET140 prof. 40 + STREET4072 prof. 40**

Materiale: Marmo o Corian

Troppopieno: NO

**Descrizione:** Top con lavabo integrato in Marmo o Corian, con sistema di scarico predisposto per sifone. La versione in Corian presenta il sistema di piletta con troppopieno invisibile.

Article: **STREET140 prof. 40 + STREET4072 prof. 40**

Material: Marble or Corian

Overflow: NO

**Description:** Top with integrated sink in Marble or Corian, with drain prepared for siphon. The Corian version features the drain system with an invisible automatic overflow.



8A

**LAVABO CENTRATO  
CENTERED SINK  
A PARETE CON FIANCHI DI CHIUSURA  
WALL MOUNTED WITH CLOSED SIDES**

**Marmo  
Marble**

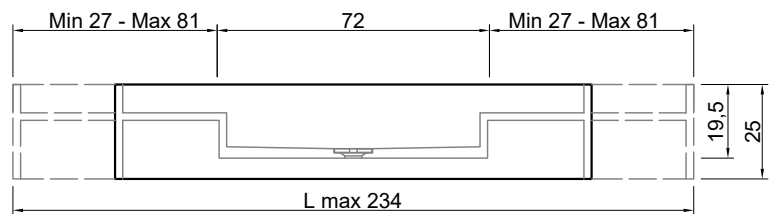

**Marmo  
Marble**

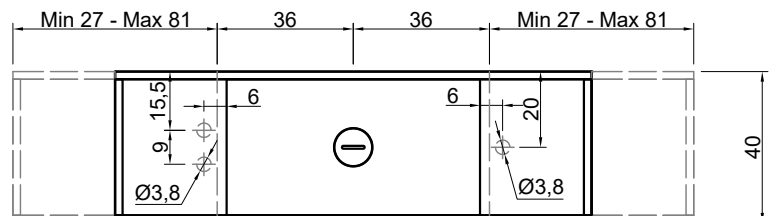

**Corian  
Corian**

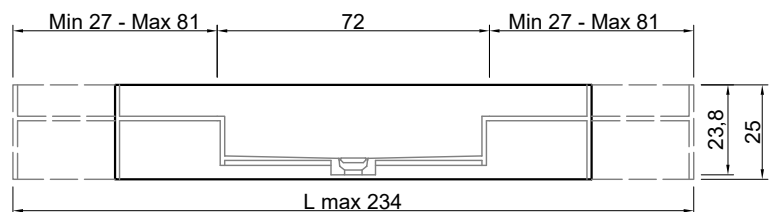

**Corian  
Corian**

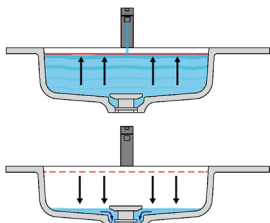
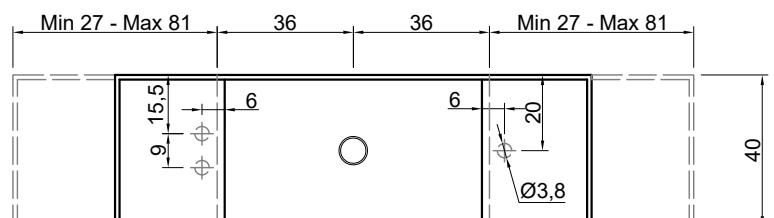

**Troppopieno automatico invisibile  
Valido solo per la versione in Corian**  
La piletta si apre automaticamente al raggiungimento del livello di sicurezza PREDEFINITO, permettendo all'acqua di defluire.

**Automatic invisible Overflow  
Valid only for the Corian version**  
The drain opens automatically when the PRESET safety level is reached allowing the water to drain away.

## STREET Consolle

Articolo: **STREET147 prof. 47 + STREET4772 prof. 47**

Materiale: Marmo o Corian

Troppopieno: NO

**Descrizione:** Top con lavabo integrato in Marmo o Corian, con sistema di scarico predisposto per sifone. La versione in Corian presenta il sistema di piletta con troppopieno invisibile.

Article: **STREET147 prof. 47 + STREET4772 prof. 47**

Material: Marble or Corian

Overflow: NO

**Description:** Top with integrated sink in Marble or Corian, with drain prepared for siphon. The Corian version features the drain system with an invisible automatic overflow.

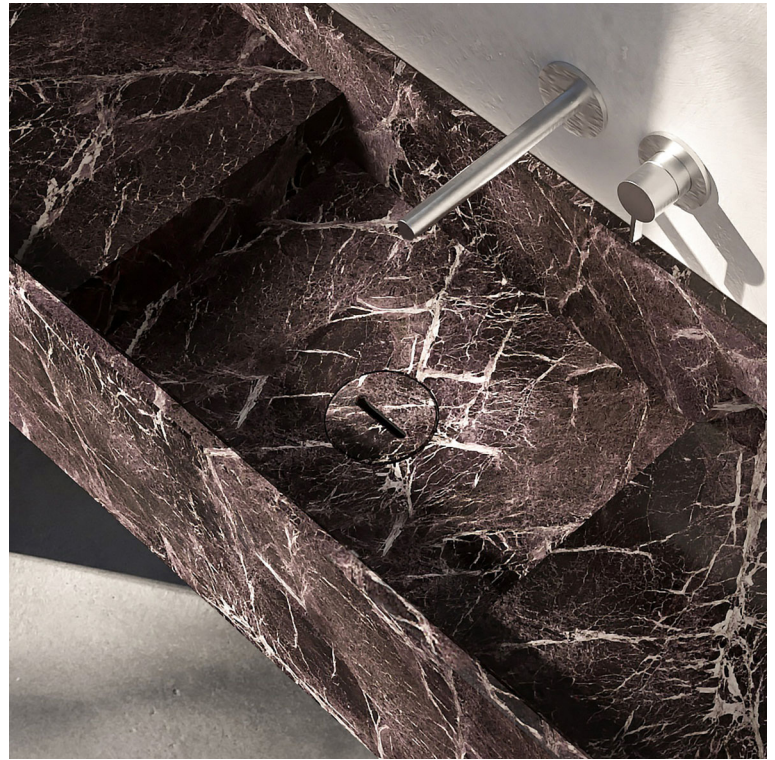

8B

**LAVABO CENTRATO  
CENTERED SINK  
A PARETE CON FIANCHI DI CHIUSURA  
WALL MOUNTED WITH CLOSED SIDES**

**Marmo  
Marble**

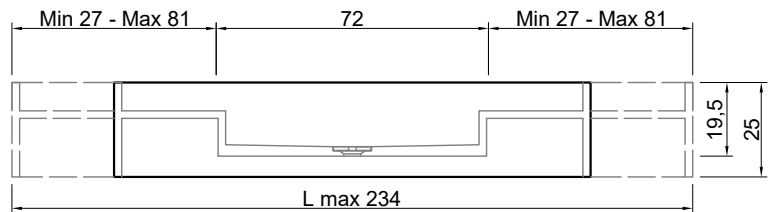

**Marmo  
Marble**

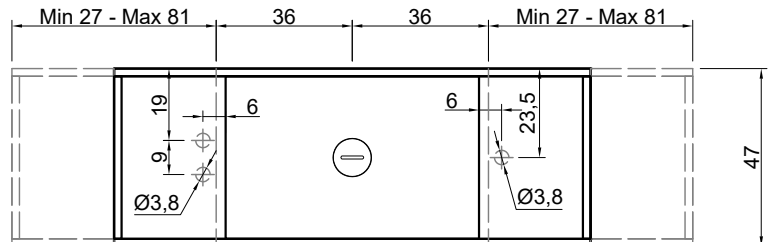

**Corian  
Corian**

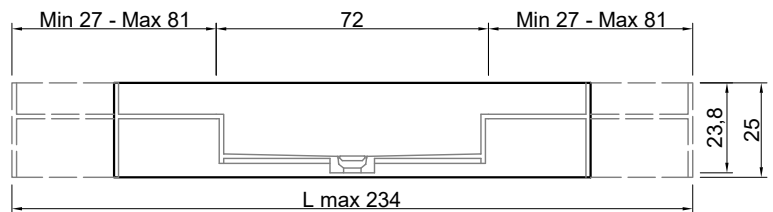

**Corian  
Corian**

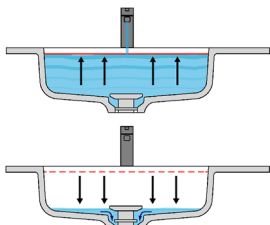
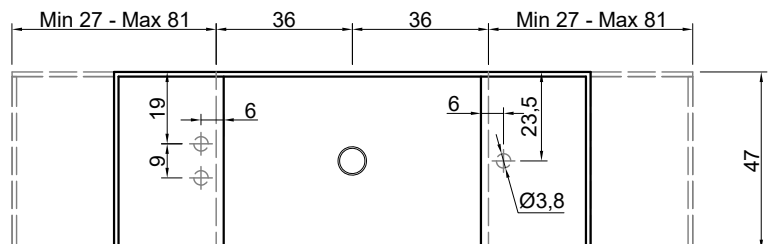

**Troppopieno automatico invisibile  
Valido solo per la versione in Corian**  
La piletta si apre automaticamente al raggiungimento del livello di sicurezza PREDEFINITO, permettendo all'acqua di defluire.

**Automatic invisible Overflow  
Valid only for the Corian version**  
The drain opens automatically when the PRESET safety level is reached allowing the water to drain away.



## STREET Consolle

Articolo: **STREET447 prof. 47 + STREET24754 prof. 47**

Materiale: Marmo o Corian

Trooppieno: NO

**Descrizione:** Top con lavabo integrato in Marmo o Corian con canale posteriore, con sistema di scarico predisposto per sifone. La versione in Corian presenta il sistema di piletta con trooppieno invisibile.

Article: **STREET447 prof. 47 + STREET24754 prof. 47**

Material: Marble or Corian

Overflow: NO

**Description:** Top with integrated sink in Marble or Corian with back canal, with drain prepared for siphon. The Corian version features the drain system with an invisible automatic overflow.



**9 LAVABO DECENTRATO CON CANALE  
OFF CENTER SINK WITH CANAL  
IN NICCHIA  
WITHIN WALLS**

 Alimentazione elettrica DC 12V  
Power supply DC 12V

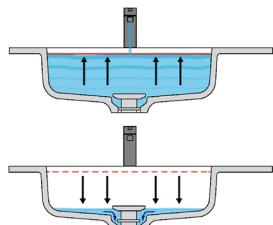

**Trooppieno automatico invisibile**  
Valido solo per la versione in Corian  
La piletta si apre automaticamente al raggiungimento del livello di sicurezza PREDEFINITO, permettendo all'acqua di defluire.

**Automatic invisible Overflow**  
Valid only for the Corian version  
The drain opens automatically when the PRESET safety level is reached allowing the water to drain away.

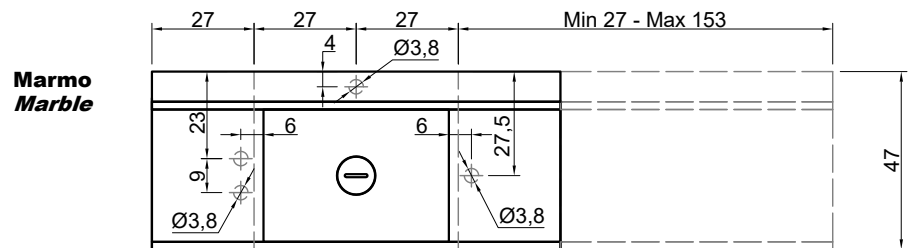
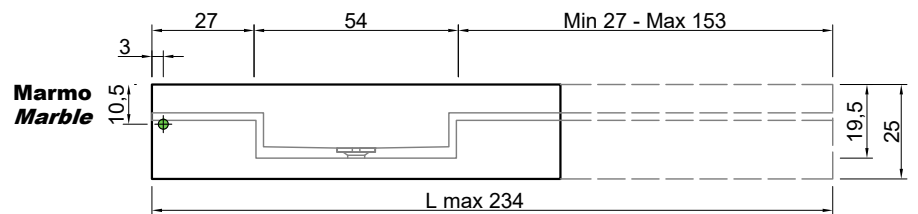

Versione sinistra  
Left version

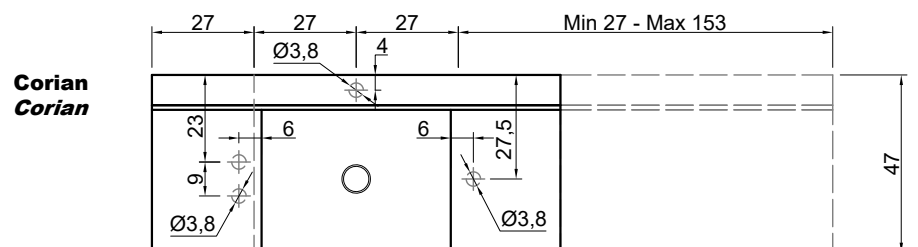
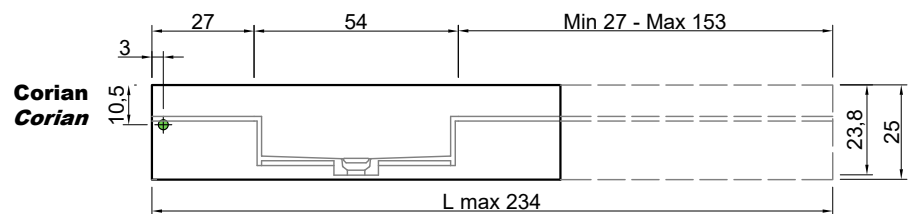



## STREET Consolle

Articolo: **STREET447 prof. 47 + STREET24772 prof. 47**

Materiale: Marmo o Corian

Troppopieno: NO

**Descrizione:** Top con lavabo integrato in Marmo o Corian con canale posteriore, con sistema di scarico predisposto per sifone. La versione in Corian presenta il sistema di piletta con troppopieno invisibile.

Article: **STREET447 prof. 47 + STREET24772 prof. 47**

Material: Marble or Corian

Overflow: NO

**Description:** Top with integrated sink in Marble or Corian with back canal, with drain prepared for siphon. The Corian version features the drain system with an invisible automatic overflow.



10

**LAVABO DECENTRATO CON CANALE  
OFF CENTER SINK WITH CANAL  
IN NICCHIA  
WITHIN WALLS**



Alimentazione  
elettrica DC 12V  
Power supply DC 12V

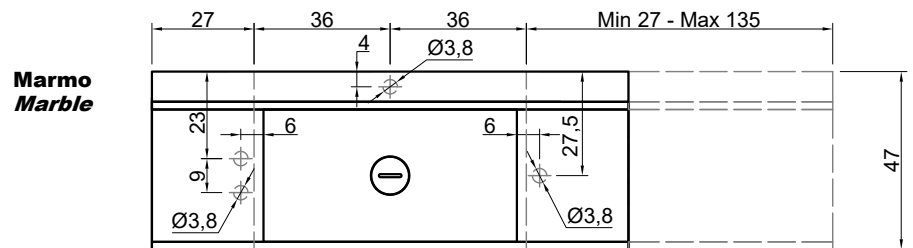
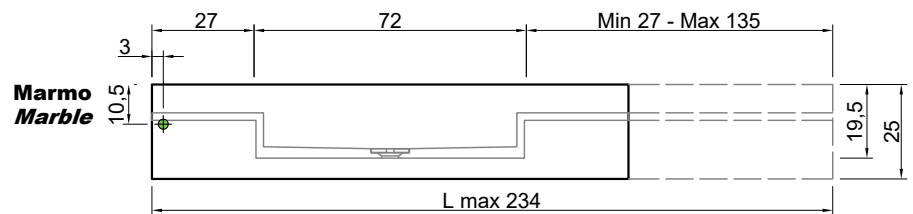

Versione sinistra  
Left version

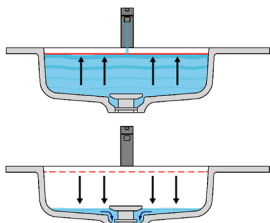
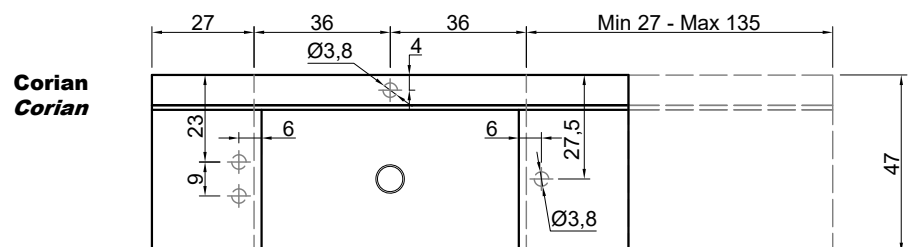
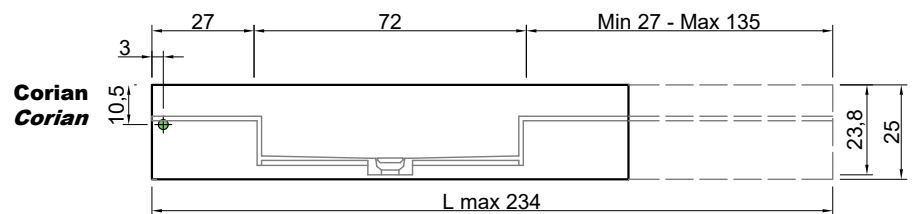

**Troppopieno automatico invisibile  
Valido solo per la versione in Corian**  
La piletta si apre automaticamente al raggiungimento del livello di sicurezza PREDEFINITO, permettendo all'acqua di defluire.

**Automatic invisible Overflow  
Valid only for the Corian version**  
The drain opens automatically when the PRESET safety level is reached allowing the water to drain away.

## STREET Consolle

Articolo: **STREET347 prof. 47 + STREET24754 prof. 47**

Materiale: Marmo o Corian

Trooppieno: NO

**Descrizione:** Top con lavabo integrato in Marmo o Corian con canale posteriore, con sistema di scarico predisposto per sifone. La versione in Corian presenta il sistema di piletta con trooppieno invisibile.

Article: **STREET347 prof. 47 + STREET24754 prof. 47**

Material: Marble or Corian

Overflow: NO

**Description:** Top with integrated sink in Marble or Corian with back canal, with drain prepared for siphon. The Corian version features the drain system with an invisible automatic overflow.



11

**LAVABO DECENTRATO CON CANALE  
OFF CENTER SINK WITH CANAL  
A PARETE CON FIANCHI DI CHIUSURA  
WALL MOUNTED WITH CLOSED SIDES**



Alimentazione  
elettrica DC 12V  
Power supply DC 12V

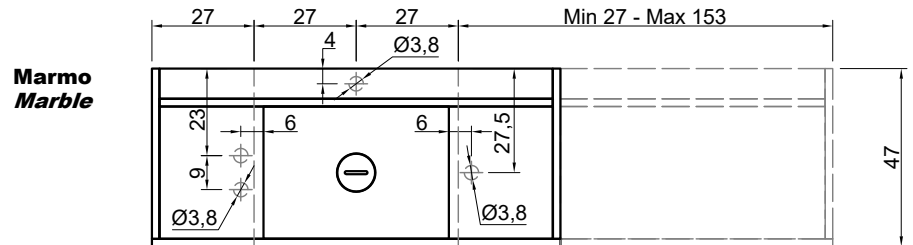
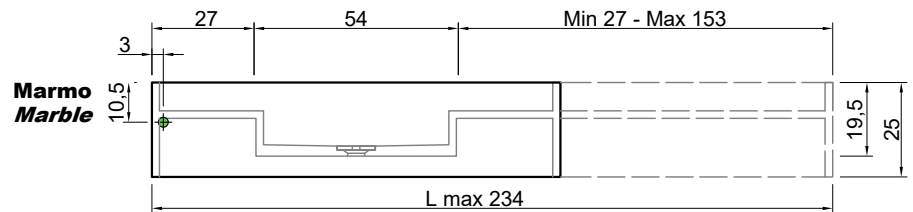

Versione sinistra  
Left version

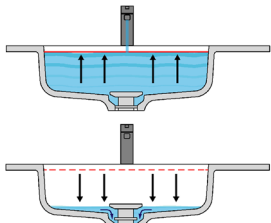
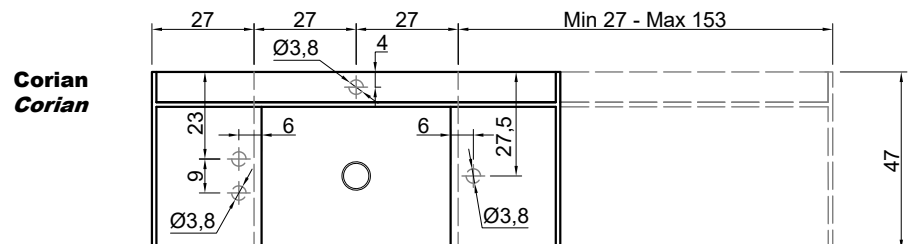
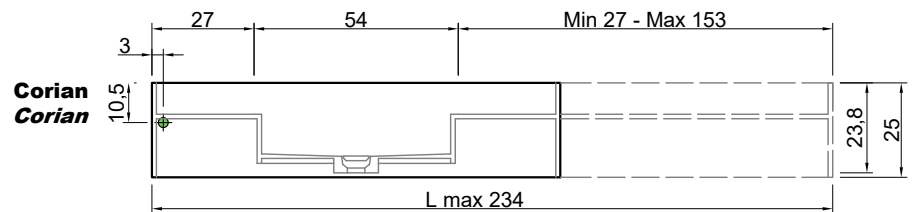

**Trooppieno automatico invisibile  
Valido solo per la versione in Corian**  
La piletta si apre automaticamente al raggiungimento del livello di sicurezza PREDEFINITO, permettendo all'acqua di defluire.

**Automatic invisible Overflow  
Valid only for the Corian version**  
The drain opens automatically when the PRESET safety level is reached allowing the water to drain away.

## STREET Consolle

Articolo: **STREET347 prof. 47 + STREET24772 prof. 47**

Materiale: Marmo o Corian  
Troppopieno: NO

**Descrizione:** Top con lavabo integrato in Marmo o Corian con canale posteriore, con sistema di scarico predisposto per sifone. La versione in Corian presenta il sistema di piletta con troppopieno invisibile.

Article: **STREET347 prof. 47 + STREET24772 prof. 47**

Material: Marble or Corian  
Overflow: NO

**Description:** Top with integrated sink in Marble or Corian with back canal, with drain prepared for siphon. The Corian version features the drain system with an invisible automatic overflow.



12

**LAVABO DECENTRATO CON CANALE  
OFF CENTER SINK WITH CANAL  
A PARETE CON FIANCHI DI CHIUSURA  
WALL MOUNTED WITH CLOSED SIDES**



Alimentazione  
elettrica DC 12V  
Power supply DC 12V

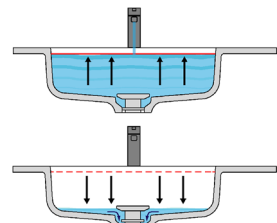

**Troppopieno automatico invisibile  
Valido solo per la versione in Corian**  
La piletta si apre automaticamente al raggiungimento del livello di sicurezza PREDEFINITO, permettendo all'acqua di defluire.

**Automatic invisible Overflow  
Valid only for the Corian version**  
The drain opens automatically when the PRESET safety level is reached allowing the water to drain away.

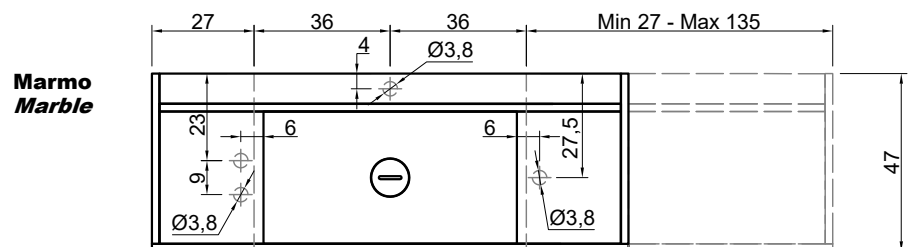
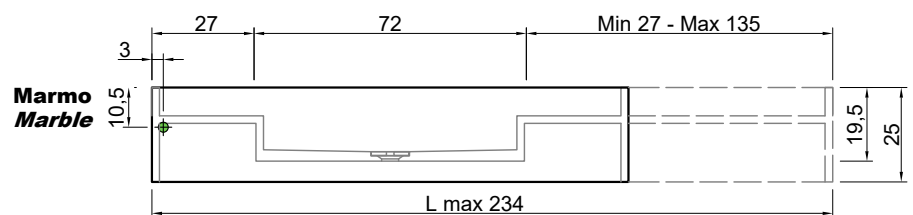

Versione sinistra  
Left version

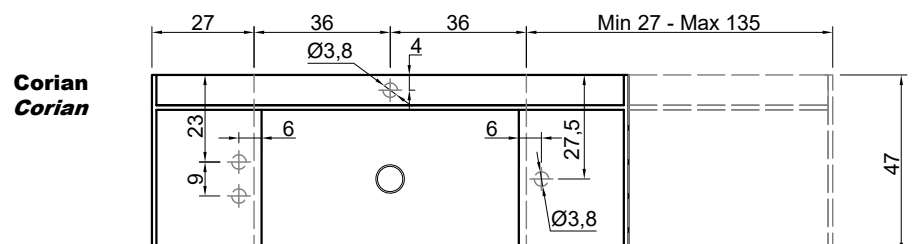
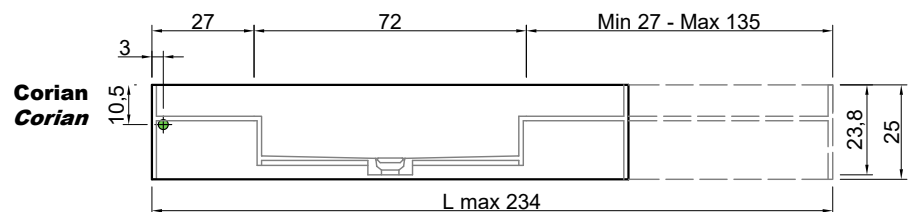



## STREET Consolle

Articolo: **STREET447 prof. 47 + STREET24754 prof. 47**

Materiale: Marmo o Corian

Troppopieno: NO

**Descrizione:** Top con lavabo integrato in Marmo o Corian con canale posteriore, con sistema di scarico predisposto per sifone. La versione in Corian presenta il sistema di piletta con troppopieno invisibile.

Article: **STREET447 prof. 47 + STREET24754 prof. 47**

Material: Marble or Corian

Overflow: NO

**Description:** Top with integrated sink in Marble or Corian with back canal, with drain prepared for siphon. The Corian version features the drain system with an invisible automatic overflow.



13

**LAVABO CENTRATO CON CANALE  
CENTERED SINK WITH CANAL  
IN NICCHIA  
WITHIN WALLS**



Alimentazione  
elettrica DC 12V  
Power supply DC 12V

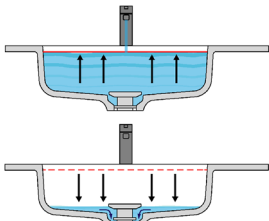
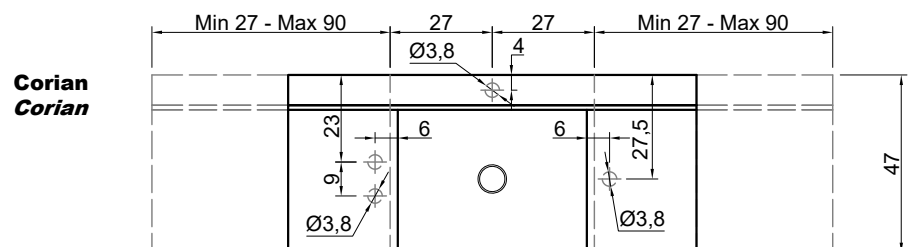
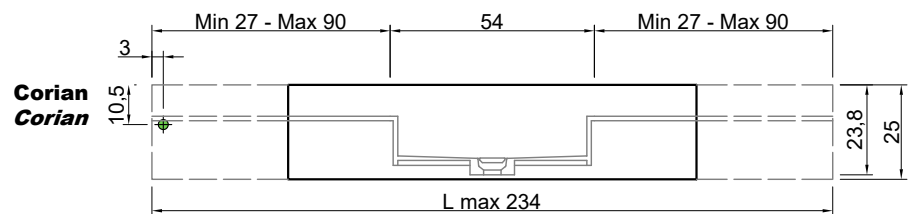
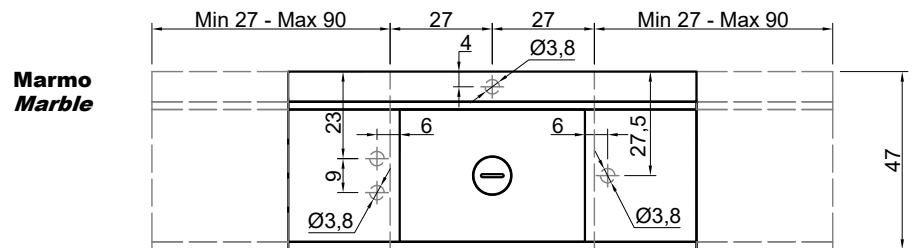
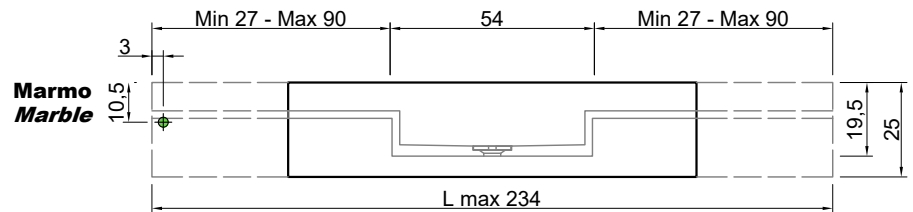

**Troppopieno automatico invisibile  
Valido solo per la versione in Corian**  
La piletta si apre automaticamente al raggiungimento del livello di sicurezza PREDEFINITO, permettendo all'acqua di defluire.

**Automatic invisible Overflow  
Valid only for the Corian version**  
The drain opens automatically when the PRESET safety level is reached allowing the water to drain away.

## STREET Consolle

Articolo: **STREET447 prof. 47 + STREET24772 prof. 47**

Materiale: Marmo o Corian

Troppopieno: NO

**Descrizione:** Top con lavabo integrato in Marmo o Corian con canale posteriore, con sistema di scarico predisposto per sifone. La versione in Corian presenta il sistema di piletta con troppopieno invisibile.

Article: **STREET447 prof. 47 + STREET24772 prof. 47**

Material: Marble or Corian

Overflow: NO

**Description:** Top with integrated sink in Marble or Corian with back canal, with drain prepared for siphon. The Corian version features the drain system with an invisible automatic overflow.



14

**LAVABO CENTRATO CON CANALE  
CENTERED SINK WITH CANAL  
IN NICCHIA  
WITHIN WALLS**



Alimentazione  
elettrica DC 12V  
Power supply DC 12V

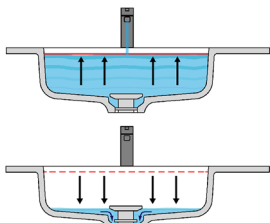
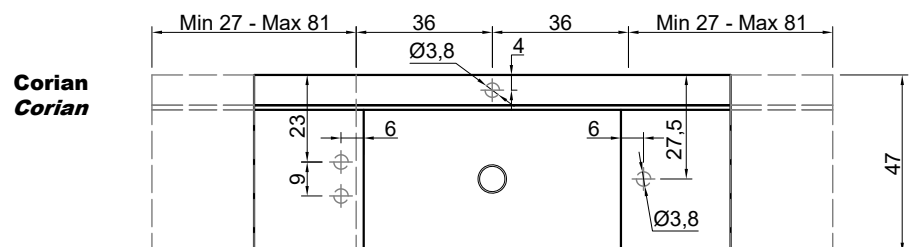
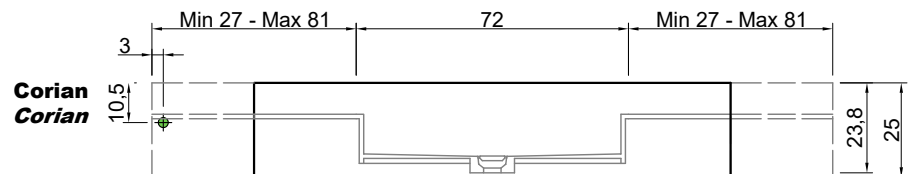
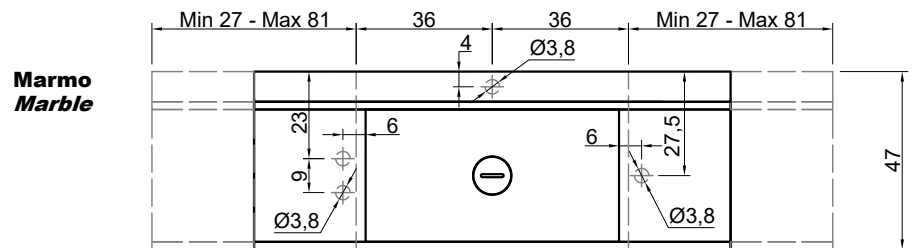
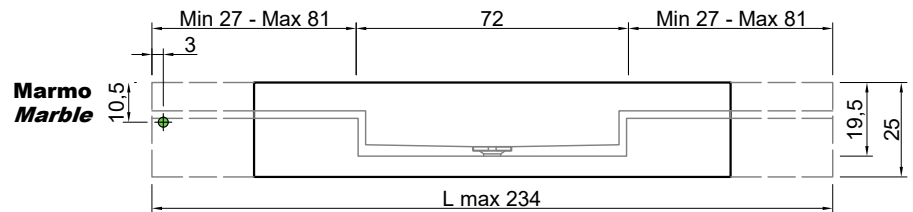

**Troppopieno automatico invisibile  
Valido solo per la versione in Corian**  
La piletta si apre automaticamente al raggiungimento del livello di sicurezza PREDEFINITO, permettendo all'acqua di defluire.

**Automatic invisible Overflow  
Valid only for the Corian version**  
The drain opens automatically when the PRESET safety level is reached allowing the water to drain away.



## STREET Consolle

Articolo: **STREET347 prof. 47 + STREET24754 prof. 47**

Materiale: Marmo o Corian

Trooppieno: NO

**Descrizione:** Top con lavabo integrato in Marmo o Corian con canale posteriore, con sistema di scarico predisposto per sifone. La versione in Corian presenta il sistema di piletta con trooppieno invisibile.

Article: **STREET347 prof. 47 + STREET24754 prof. 47**

Material: Marble or Corian

Overflow: NO

**Description:** Top with integrated sink in Marble or Corian with back canal, with drain prepared for siphon. The Corian version features the drain system with an invisible automatic overflow.



15

**LAVABO CENTRATO CON CANALE  
CENTERED SINK WITH CANAL  
A PARETE CON FIANCHI DI CHIUSURA  
WALL MOUNTED WITH CLOSED SIDES**



Alimentazione  
elettrica DC 12V  
Power supply DC 12V

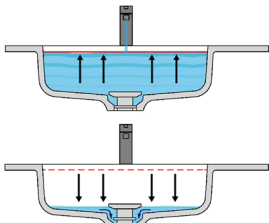
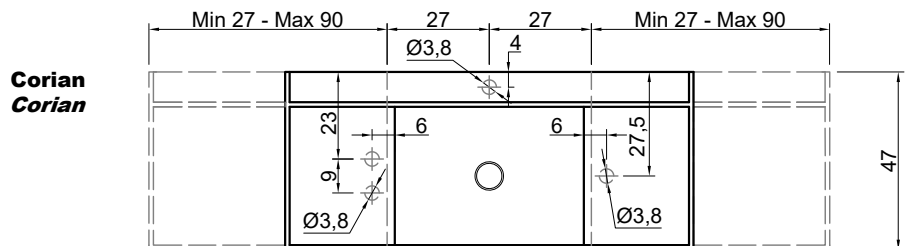
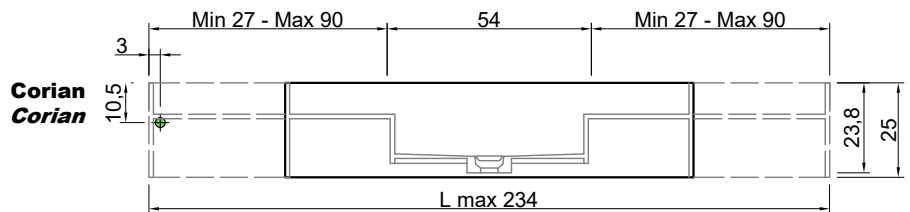
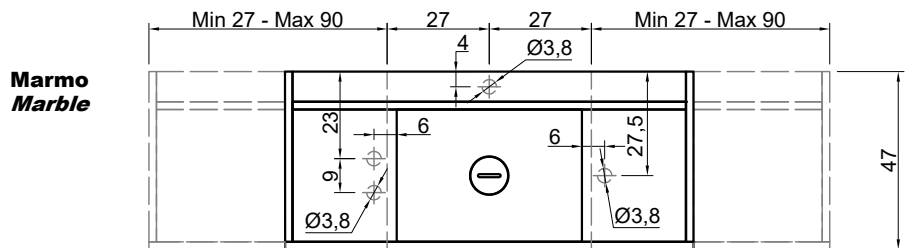
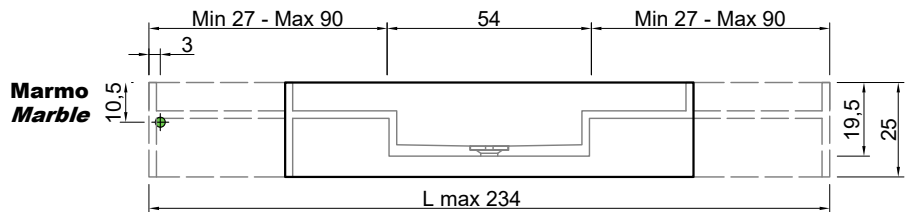

**Trooppieno automatico invisibile  
Valido solo per la versione in Corian**  
La piletta si apre automaticamente al raggiungimento del livello di sicurezza PREDEFINITO, permettendo all'acqua di defluire.

**Automatic invisible Overflow  
Valid only for the Corian version**  
The drain opens automatically when the PRESET safety level is reached allowing the water to drain away.



## STREET Consolle

Articolo: **STREET347 prof. 47 + STREET24772 prof. 47**

Materiale: Marmo o Corian

Troppopieno: NO

**Descrizione:** Top con lavabo integrato in Marmo o Corian con canale posteriore, con sistema di scarico predisposto per sifone. La versione in Corian presenta il sistema di piletta con troppopieno invisibile.

Article: **STREET347 prof. 47 + STREET24772 prof. 47**

Material: Marble or Corian

Overflow: NO

**Description:** Top with integrated sink in Marble or Corian with back canal, with drain prepared for siphon. The Corian version features the drain system with an invisible automatic overflow.



16

**LAVABO CENTRATO CON CANALE  
CENTERED SINK WITH CANAL  
A PARETE CON FIANCHI DI CHIUSURA  
WALL MOUNTED WITH CLOSED SIDES**



Alimentazione  
elettrica DC 12V  
Power supply DC 12V

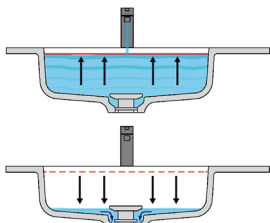
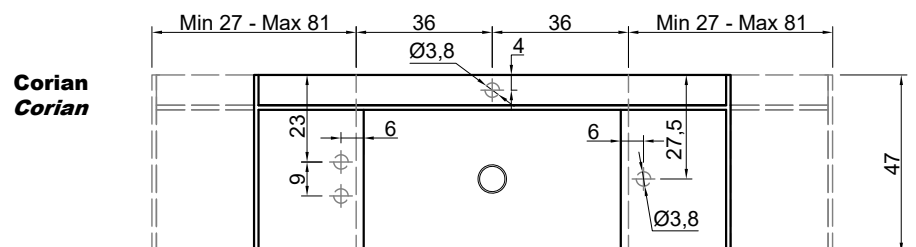
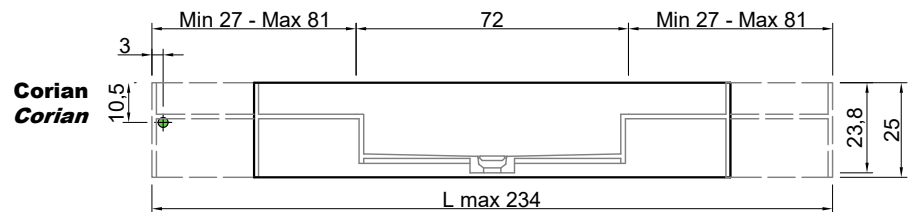
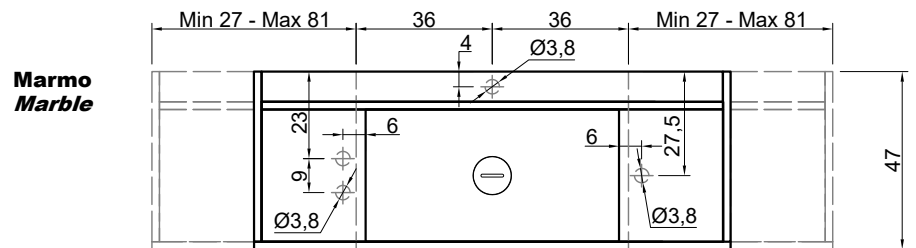
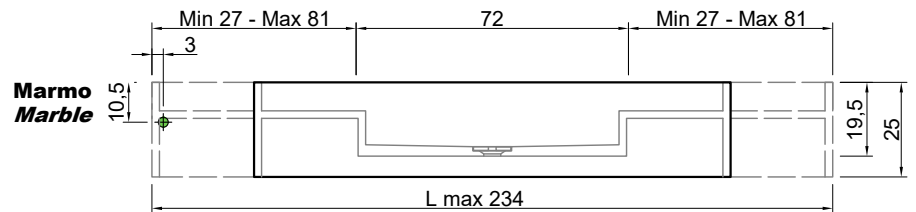

**Troppopieno automatico invisibile  
Valido solo per la versione in Corian**  
La piletta si apre automaticamente al raggiungimento del livello di sicurezza PREDEFINITO, permettendo all'acqua di defluire.

**Automatic invisible Overflow  
Valid only for the Corian version**  
The drain opens automatically when the PRESET safety level is reached allowing the water to drain away.

## STREET Consolle

Articolo: **STREET240 prof. 40 + N°2 STREET4054 prof. 40**

Materiale: Marmo o Corian

Troppo pieno: NO

**Descrizione:** Top con doppio lavabo integrato in Marmo o Corian, con sistema di scarico predisposto per sifone. La versione in Corian presenta il sistema di piletta con troppopieno invisibile.

Article: **STREET240 prof. 40 + N°2 STREET4054 prof. 40**

Material: Marble or Corian

Overflow: NO

**Description:** Top with double integrated sink in Marble or Corian, with drain prepared for siphon. The Corian version features the drain system with an invisible automatic overflow.



17A

**LAVABO DOPPIO  
DOUBLE SINK  
IN NICCHIA  
WHITINN WALLS**

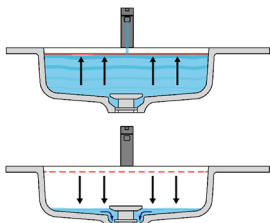
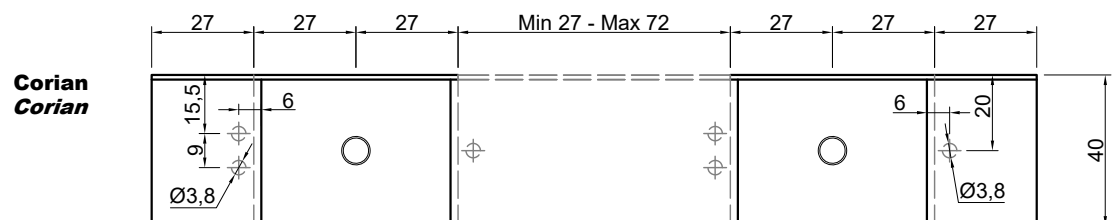
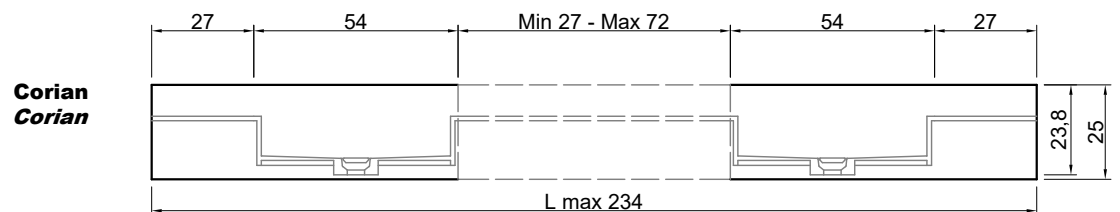
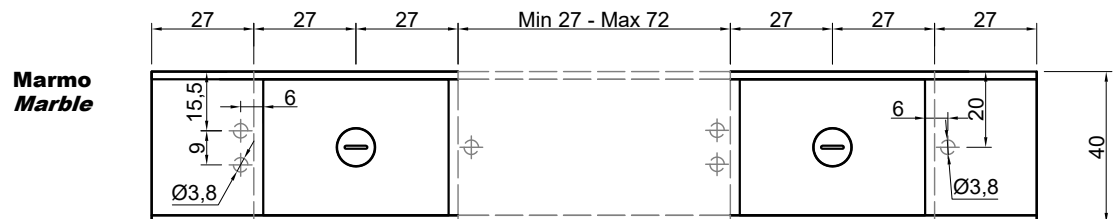
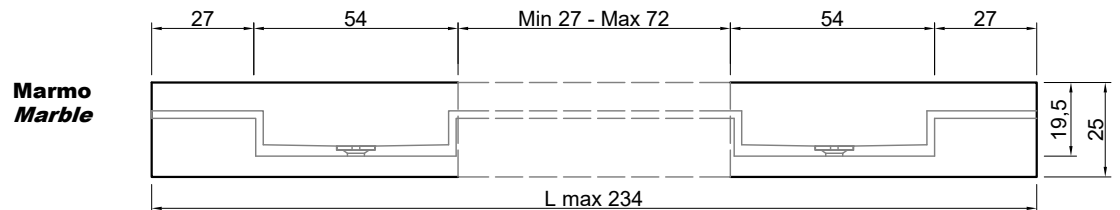

**Troppo pieno automatico invisibile**  
Valido solo per la versione in Corian  
La piletta si apre automaticamente al raggiungimento del livello di sicurezza PREDEFINITO, permettendo all'acqua di defluire.

**Automatic invisible Overflow**  
Valid only for the Corian version  
The drain opens automatically when the PRESET safety level is reached allowing the water to drain away.

## STREET Consolle

Articolo: **STREET247 prof. 47 + N°2 STREET4754 prof. 47**

Materiale: Marmo o Corian

Troppopieno: NO

**Descrizione:** Top con doppio lavabo integrato in Marmo o Corian, con sistema di scarico predisposto per sifone. La versione in Corian presenta il sistema di piletta con troppopieno invisibile.

Article: **STREET247 prof. 47 + N°2 STREET4754 prof. 47**

Material: Marble or Corian

Overflow: NO

**Description:** Top with double integrated sink in Marble or Corian, with drain prepared for siphon. The Corian version features the drain system with an invisible automatic overflow.

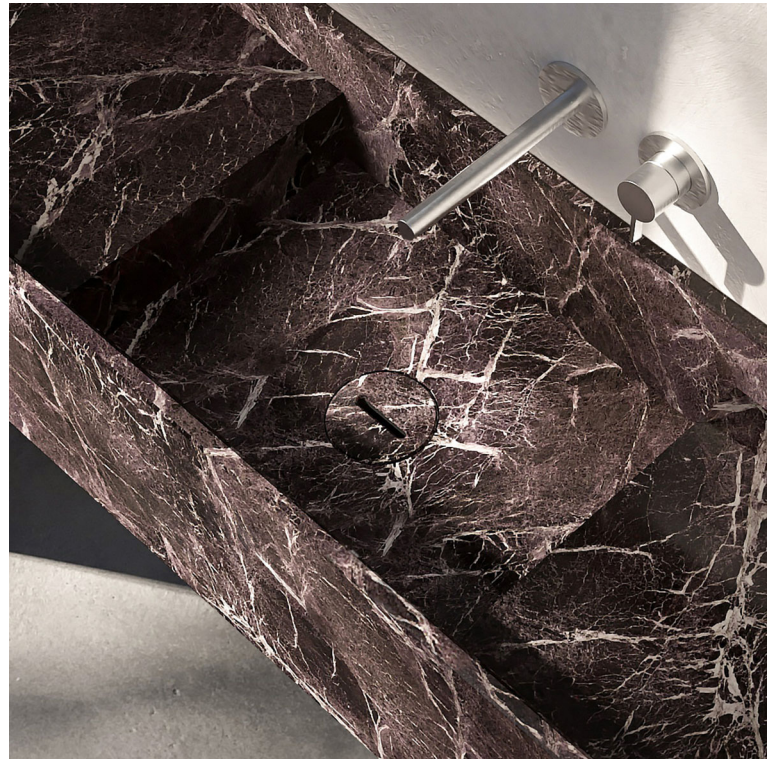

17B

**LAVABO DOPPIO  
DOUBLE SINK  
IN NICCHIA  
WHITINN WALLS**

**Marmo  
Marble**

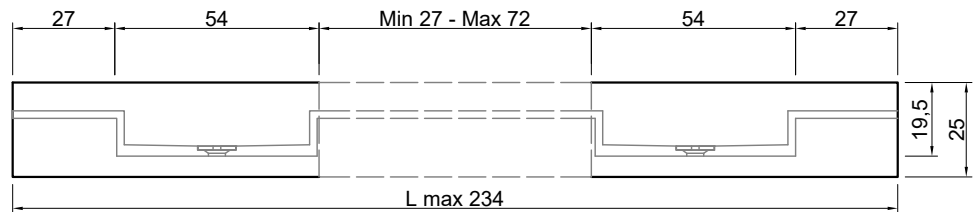

**Marmo  
Marble**

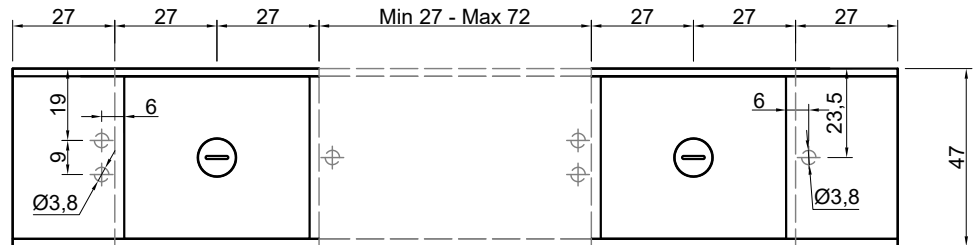

**Corian  
Corian**

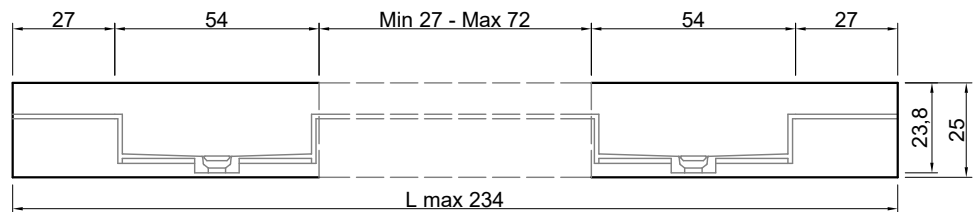

**Corian  
Corian**

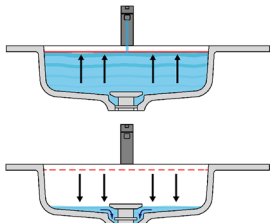
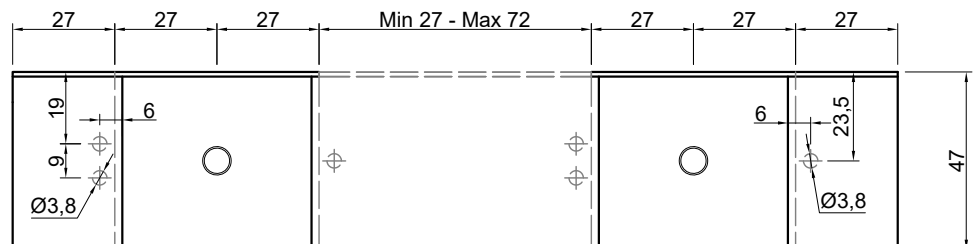

**Troppopieno automatico invisibile  
Valido solo per la versione in Corian**  
La piletta si apre automaticamente al raggiungimento del livello di sicurezza PREDEFINITO, permettendo all'acqua di defluire.

**Automatic invisible Overflow  
Valid only for the Corian version**  
The drain opens automatically when the PRESET safety level is reached allowing the water to drain away.



## STREET Consolle

Articolo: **STREET240 prof. 40 + N°2 STREET4072 prof. 40**

Materiale: Marmo o Corian

Troppo pieno: NO

**Descrizione:** Top con doppio lavabo integrato in Marmo o Corian, con sistema di scarico predisposto per sifone. La versione in Corian presenta il sistema di piletta con troppopieno invisibile.

Article: **STREET240 prof. 40 + N°2 STREET4072 prof. 40**

Material: Marble or Corian

Overflow: NO

**Description:** Top with double integrated sink in Marble or Corian, with drain prepared for siphon. The Corian version features the drain system with an invisible automatic overflow.



18A

**LAVABO DOPPIO  
DOUBLE SINK  
IN NICCHIA  
WHITIN WALLS**

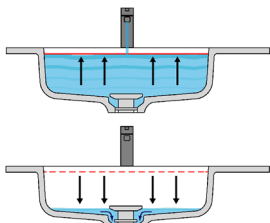
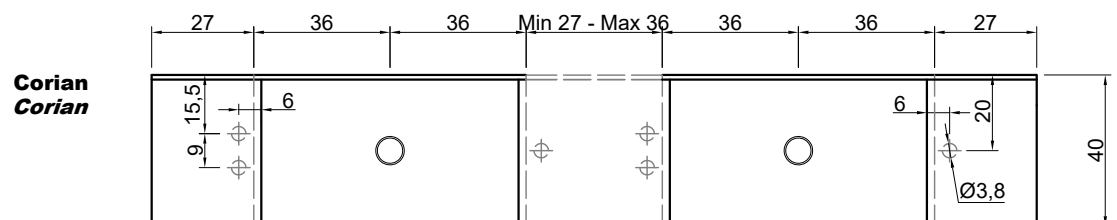
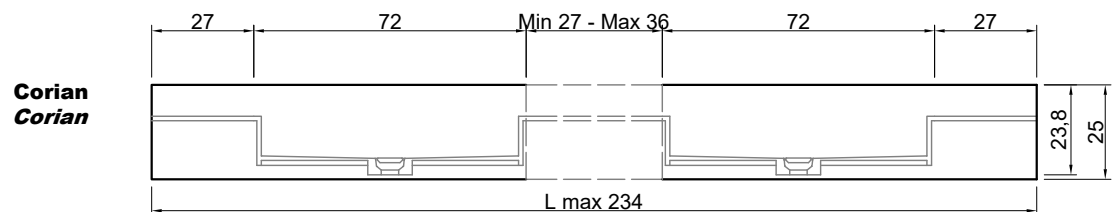
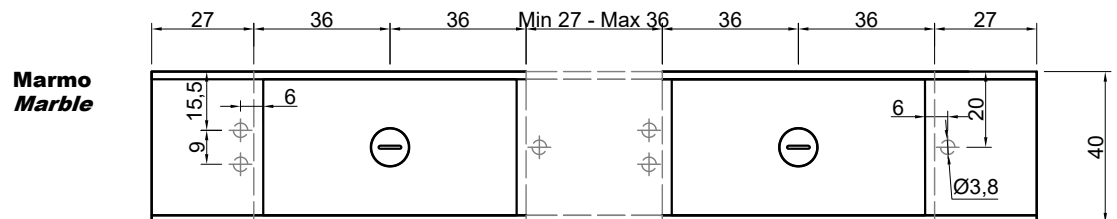
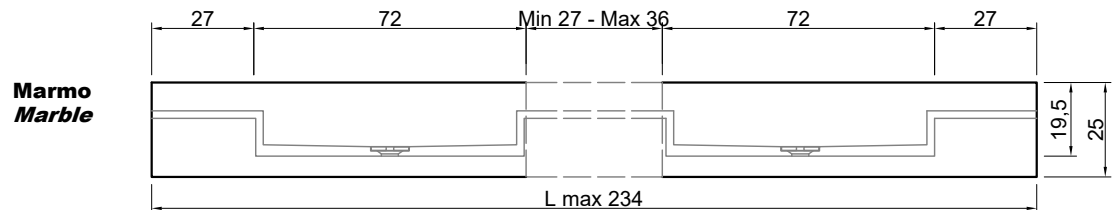

**Troppo pieno automatico invisibile**  
Valido solo per la versione in Corian  
La piletta si apre automaticamente al raggiungimento del livello di sicurezza PREDEFINITO, permettendo all'acqua di defluire.

**Automatic invisible Overflow**  
Valid only for the Corian version  
The drain opens automatically when the PRESET safety level is reached allowing the water to drain away.

## STREET Consolle

Articolo: **STREET247 prof. 47 + N°2 STREET4772 prof. 47**

Materiale: Marmo o Corian

Troppo pieno: NO

**Descrizione:** Top con doppio lavabo integrato in Marmo o Corian, con sistema di scarico predisposto per sifone. La versione in Corian presenta il sistema di piletta con troppopieno invisibile.

Article: **STREET247 prof. 47 + N°2 STREET4772 prof. 47**

Material: Marble or Corian

Overflow: NO

**Description:** Top with double integrated sink in Marble or Corian, with drain prepared for siphon. The Corian version features the drain system with an invisible automatic overflow.

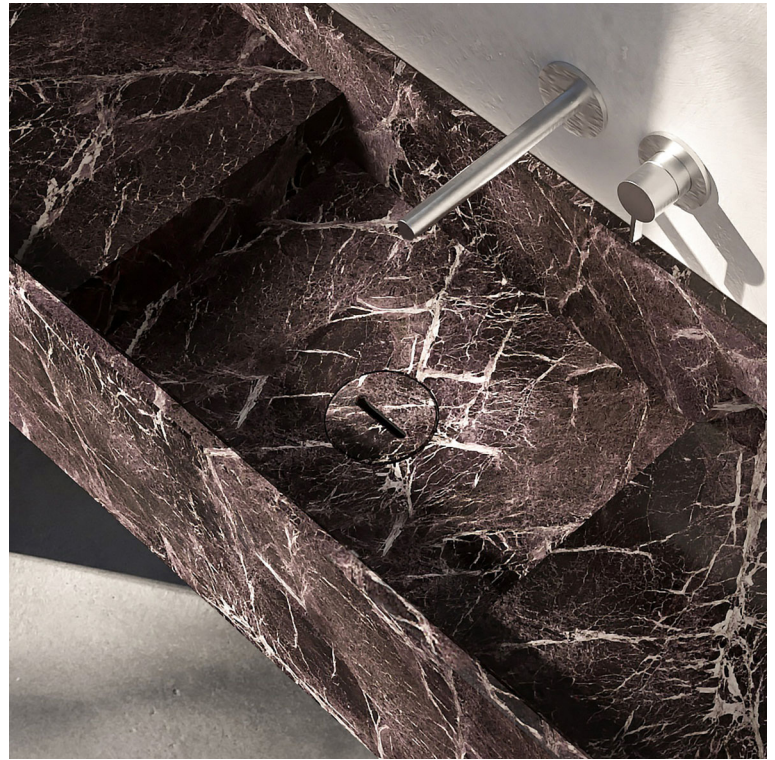

18B

**LAVABO DOPPIO  
DOUBLE SINK  
IN NICCHIA  
WHITIN WALLS**

**Marmo  
Marble**

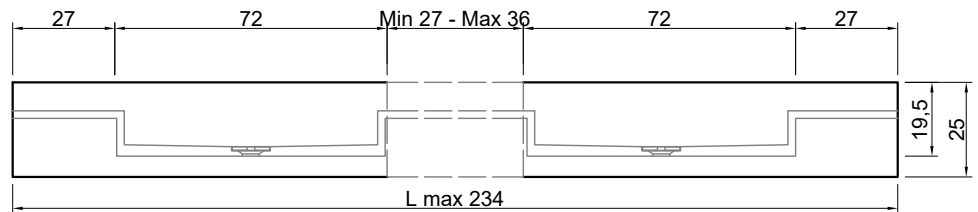

**Marmo  
Marble**

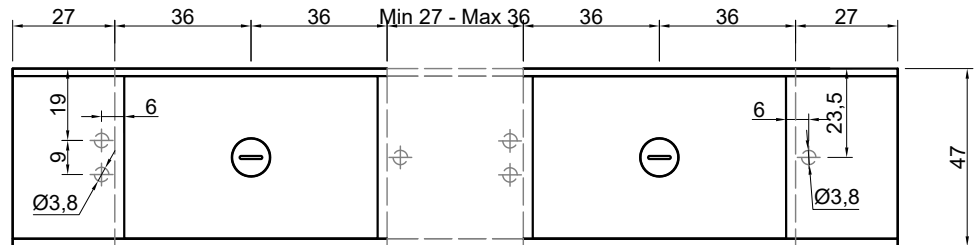

**Corian  
Corian**

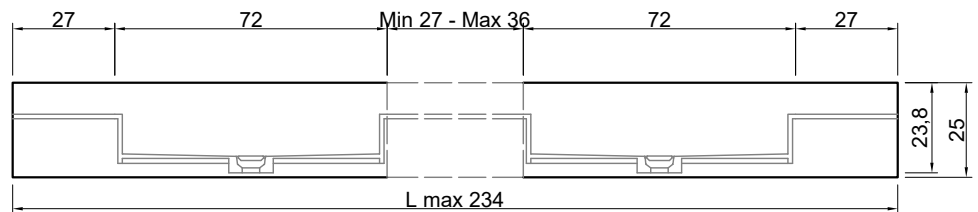

**Corian  
Corian**

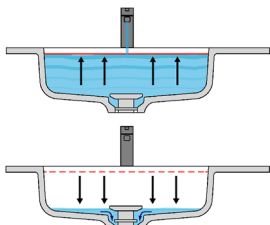
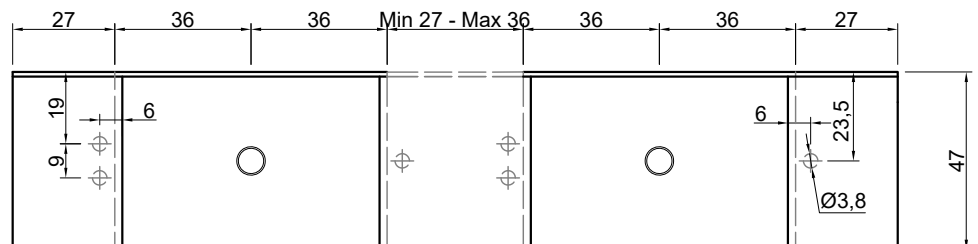

**Troppo pieno automatico invisibile**  
Valido solo per la versione in Corian  
La piletta si apre automaticamente al raggiungimento del livello di sicurezza PREDEFINITO, permettendo all'acqua di defluire.

**Automatic invisible Overflow**  
Valid only for the Corian version  
The drain opens automatically when the PRESET safety level is reached allowing the water to drain away.



## STREET Consolle

Articolo: **STREET140 prof. 40 + N°2 STREET4054 prof. 40**

Materiale: Marmo o Corian

Troppopieno: NO

**Descrizione:** Top con doppio lavabo integrato in Marmo o Corian, con sistema di scarico predisposto per sifone. La versione in Corian presenta il sistema di piletta con troppopieno invisibile.

Article: **STREET140 prof. 40 + N°2 STREET4054 prof. 40**

Material: Marble or Corian

Overflow: NO

**Description:** Top with double integrated sink in Marble or Corian, with drain prepared for siphon. The Corian version features the drain system with an invisible automatic overflow.

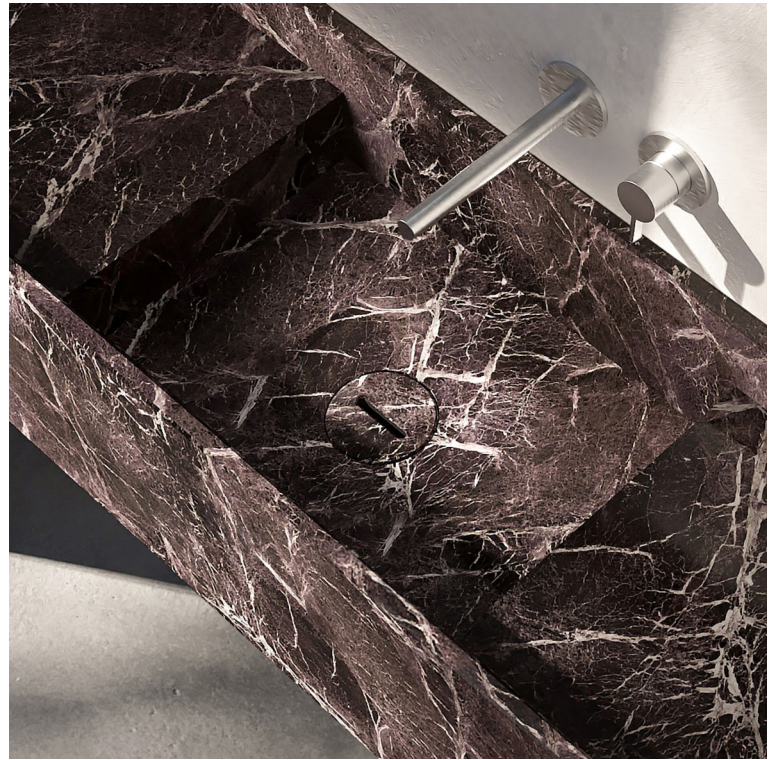

19A

**LAVABO DOPPIO  
DOUBLE SINK  
A PARETE CON FIANCHI DI CHIUSURA  
WALL MOUNTED WITH CLOSED SIDES**

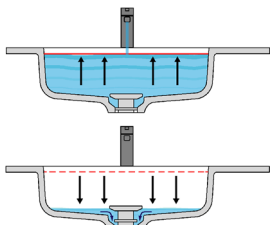
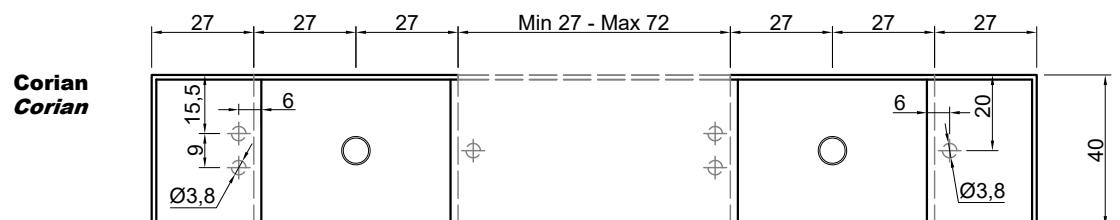
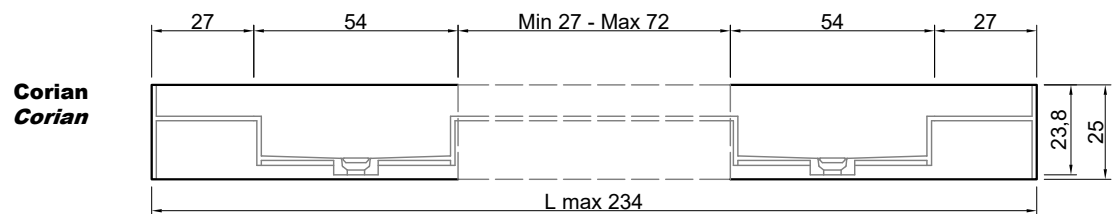
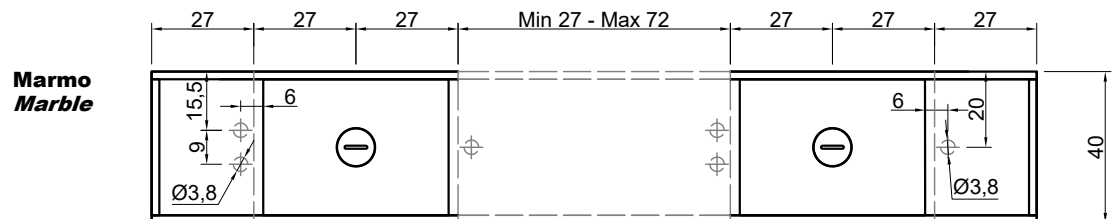
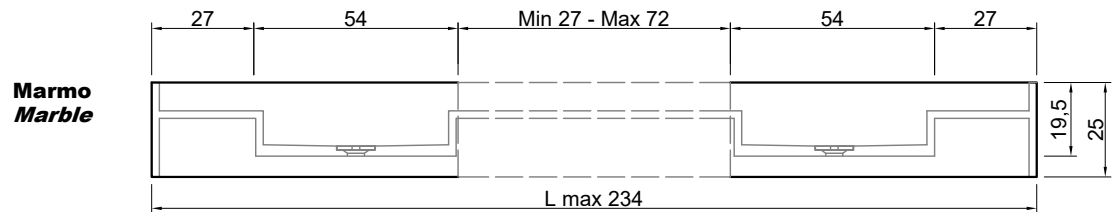

**Troppopieno automatico invisibile  
Valido solo per la versione in Corian**  
La piletta si apre automaticamente al raggiungimento del livello di sicurezza PREDEFINITO, permettendo all'acqua di defluire.

**Automatic invisible Overflow  
Valid only for the Corian version**  
The drain opens automatically when the PRESET safety level is reached allowing the water to drain away.



## STREET Consolle

Articolo: **STREET147 prof. 47 + N°2 STREET4754 prof. 47**

Materiale: Marmo o Corian

Troppopieno: NO

**Descrizione:** Top con doppio lavabo integrato in Marmo o Corian, con sistema di scarico predisposto per sifone. La versione in Corian presenta il sistema di piletta con troppopieno invisibile.

Article: **STREET147 prof. 47 + N°2 STREET4754 prof. 47**

Material: Marble or Corian

Overflow: NO

**Description:** Top with double integrated sink in Marble or Corian, with drain prepared for siphon. The Corian version features the drain system with an invisible automatic overflow.

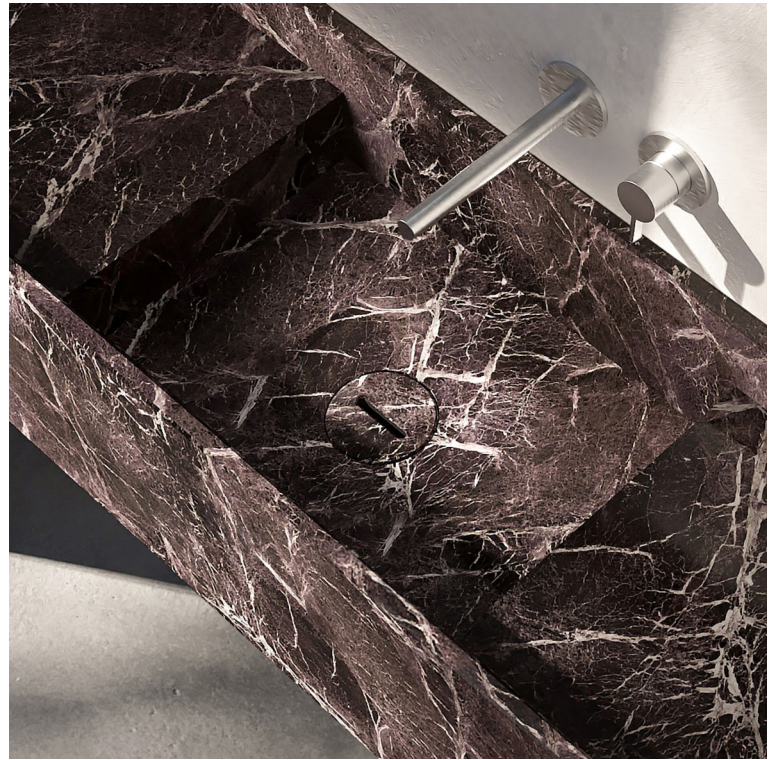

19B

**LAVABO DOPPIO  
DOUBLE SINK  
A PARETE CON FIANCHI DI CHIUSURA  
WALL MOUNTED WITH CLOSED SIDES**

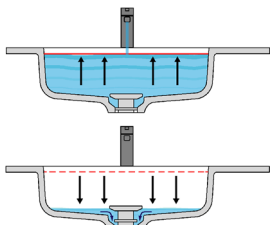
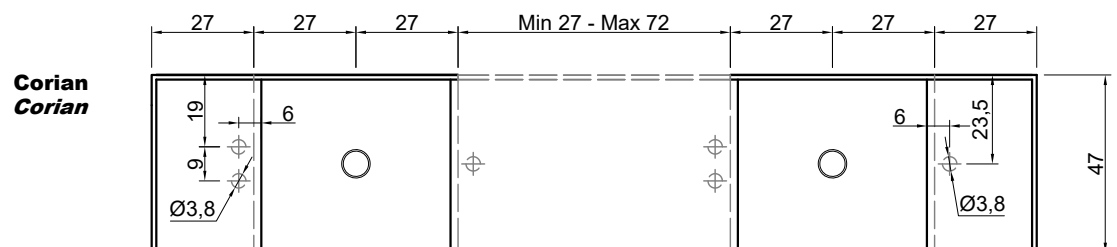
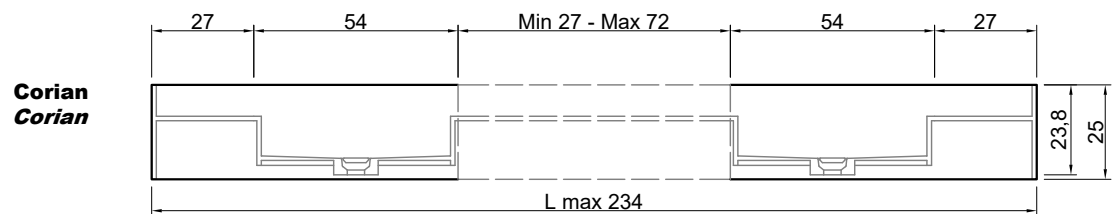
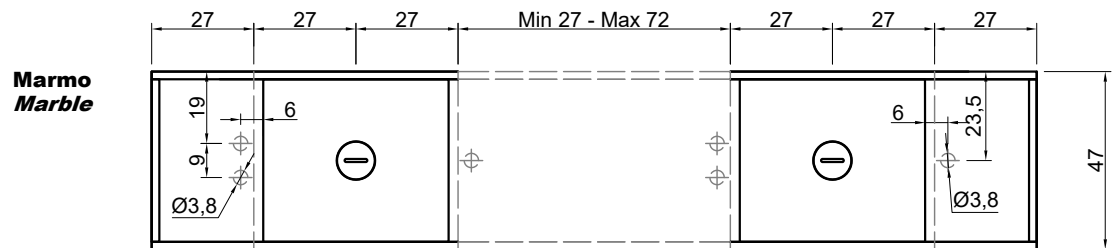
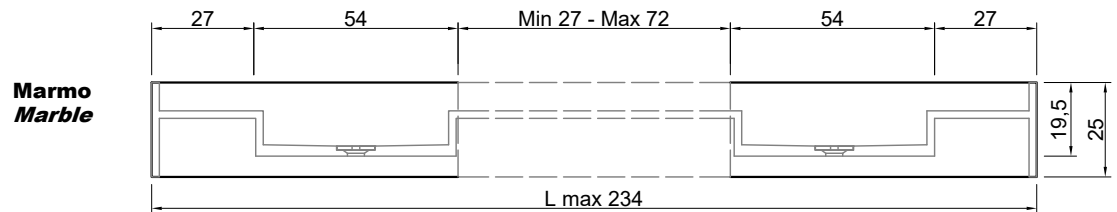

**Troppopieno automatico invisibile  
Valido solo per la versione in Corian**  
La piletta si apre automaticamente al raggiungimento del livello di sicurezza PREDEFINITO, permettendo all'acqua di defluire.

**Automatic invisible Overflow  
Valid only for the Corian version**  
The drain opens automatically when the PRESET safety level is reached allowing the water to drain away.

## STREET Consolle

Articolo: **STREET140 prof. 40 + N°2 STREET4072 prof. 40**

Materiale: Marmo o Corian

Troppo pieno: NO

**Descrizione:** Top con doppio lavabo integrato in Marmo o Corian, con sistema di scarico predisposto per sifone. La versione in Corian presenta il sistema di piletta con troppopieno invisibile.

Article: **STREET140 prof. 40 + N°2 STREET4072 prof. 40**

Material: Marble or Corian

Overflow: NO

**Description:** Top with double integrated sink in Marble or Corian, with drain prepared for siphon. The Corian version features the drain system with an invisible automatic overflow.

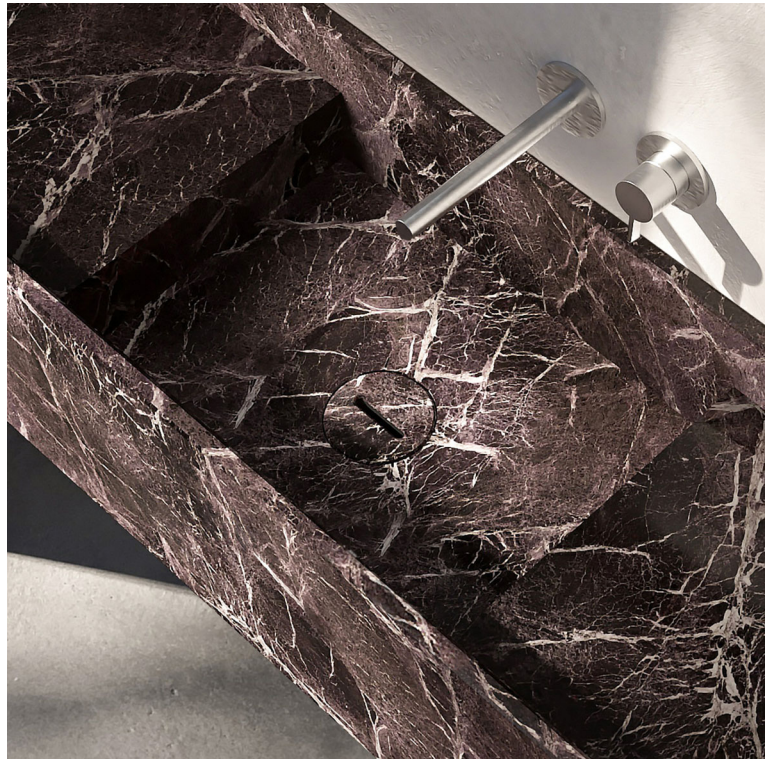

20A

**LAVABO DOPPIO  
DOUBLE SINK  
A PARETE CON FIANCHI DI CHIUSURA  
WALL MOUNTED WITH CLOSED SIDES**

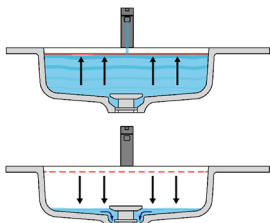
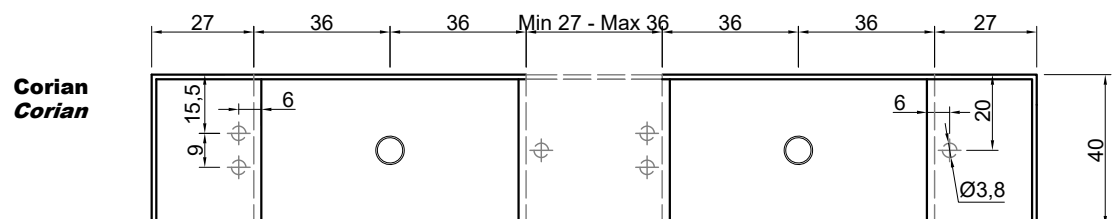
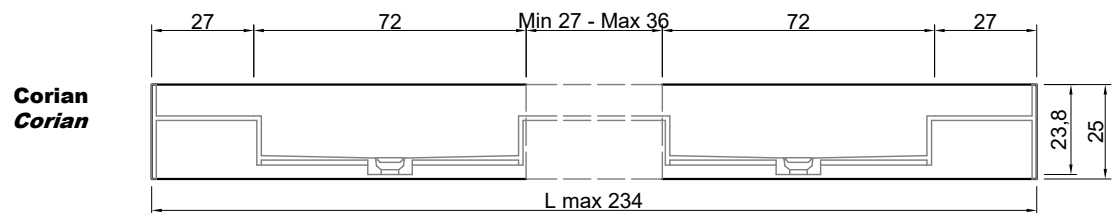
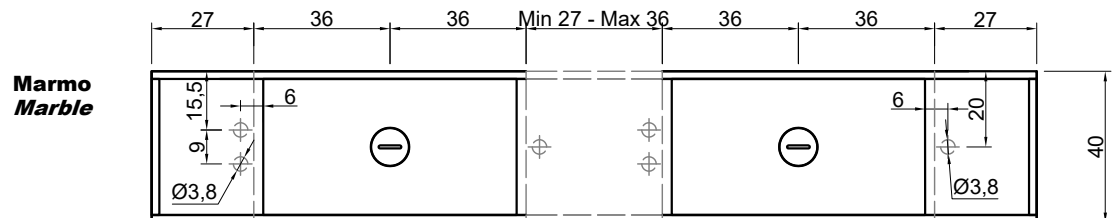
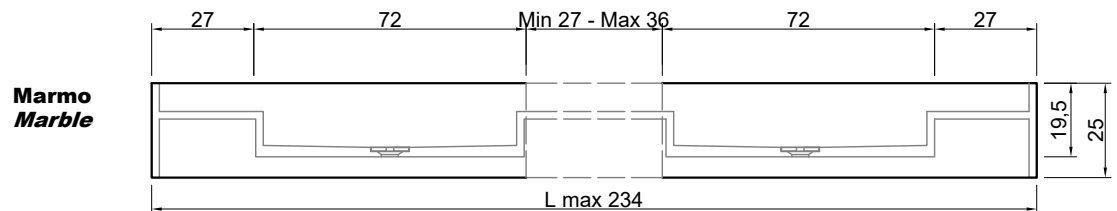

**Troppo pieno automatico invisibile**  
Valido solo per la versione in Corian  
La piletta si apre automaticamente al raggiungimento del livello di sicurezza PREDEFINITO, permettendo all'acqua di defluire.

**Automatic invisible Overflow**  
Valid only for the Corian version  
The drain opens automatically when the PRESET safety level is reached allowing the water to drain away.



## STREET Consolle

Articolo: **STREET147 prof. 47 + N°2 STREET4772 prof. 47**

Materiale: Marmo o Corian

Troppo pieno: NO

**Descrizione:** Top con doppio lavabo integrato in Marmo o Corian con sistema di scarico predisposto per sifone. La versione in Corian presenta il sistema di piletta con troppopieno invisibile.

Article: **STREET147 prof. 47 + N°2 STREET4772 prof. 47**

Material: Marble or Corian

Overflow: NO

**Description:** Top with double integrated sink in Marble or Corian with drain prepared for siphon. The Corian version features the drain system with an invisible automatic overflow.

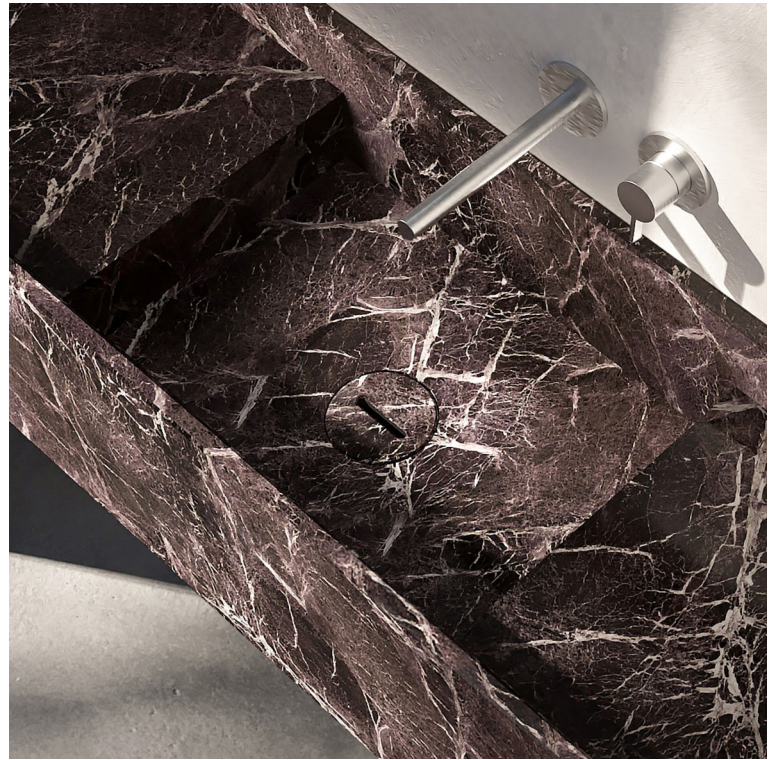

20B

**LAVABO DOPPIO  
DOUBLE SINK  
A PARETE CON FIANCHI DI CHIUSURA  
WALL MOUNTED WITH CLOSED SIDES**

**Marmo  
Marble**

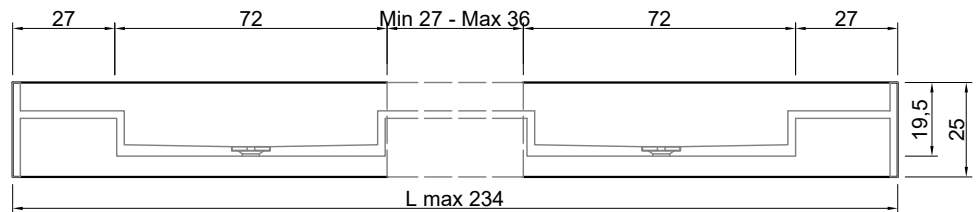

**Marmo  
Marble**

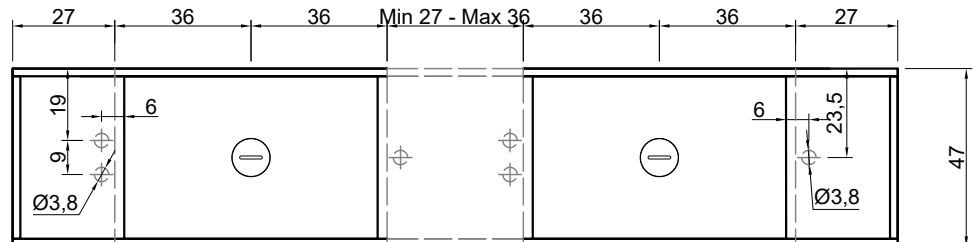

**Corian  
Corian**

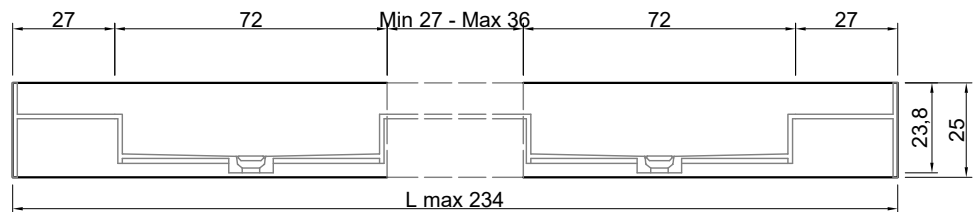

**Corian  
Corian**

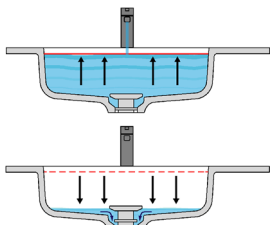
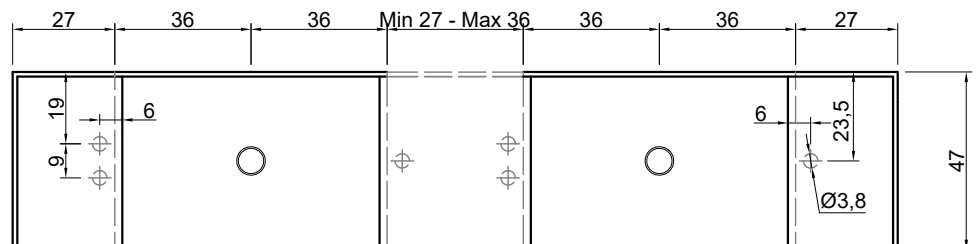

**Troppo pieno automatico invisibile  
Valido solo per la versione in Corian**  
La piletta si apre automaticamente al raggiungimento del livello di sicurezza PREDEFINITO, permettendo all'acqua di defluire.

**Automatic invisible Overflow  
Valid only for the Corian version**  
The drain opens automatically when the PRESET safety level is reached allowing the water to drain away.



## STREET Consolle

Articolo: **STREET447 prof. 47 + N°2 STREET24754 prof. 47**

Materiale: Marmo o Corian

Trooppieno: NO

**Descrizione:** Top con doppio lavabo integrato in Marmo o Corian con canale posteriore, con sistema di scarico predisposto per sifone. La versione in Corian presenta il sistema di piletta con trooppieno invisibile.

Article: **STREET447 prof. 47 + N°2 STREET24754 prof. 47**

Material: Marble or Corian

Overflow: NO

**Description:** Top with double integrated sink in Marble or Corian with back canal, with drain prepared for siphon. The Corian version features the drain system with an invisible automatic overflow.



**21 LAVABO DOPPIO CON CANALE  
DOUBLE SINK WITH CANAL  
IN NICCHIA  
WITHIN WALLS**

 Alimentazione elettrica DC 12V  
Power supply DC 12V

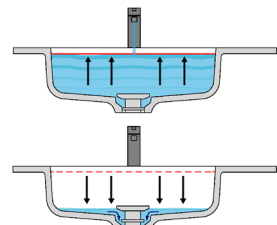
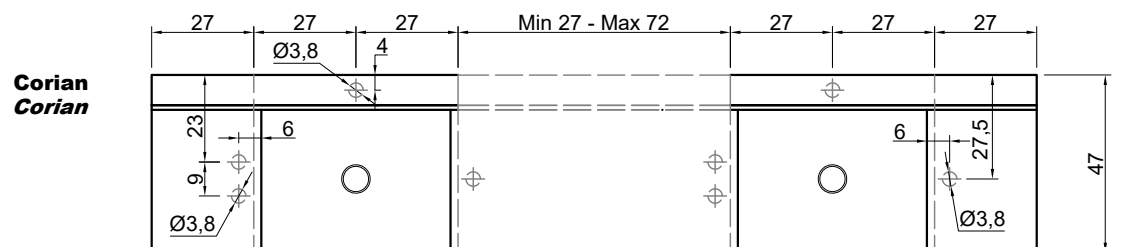
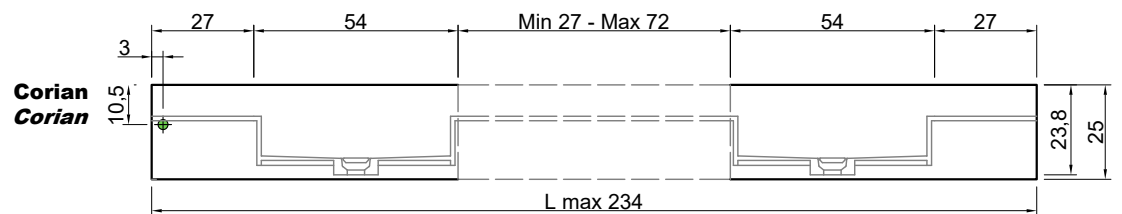
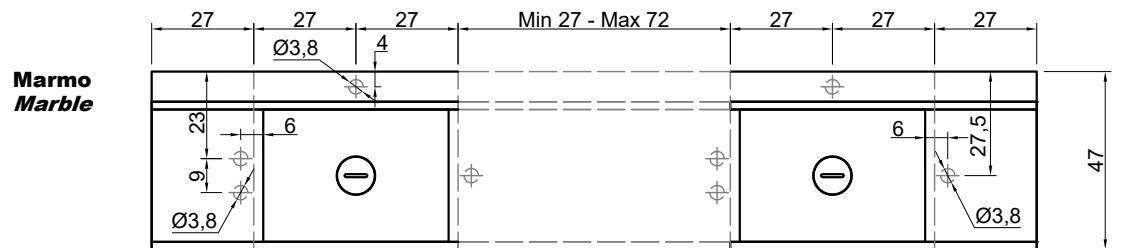
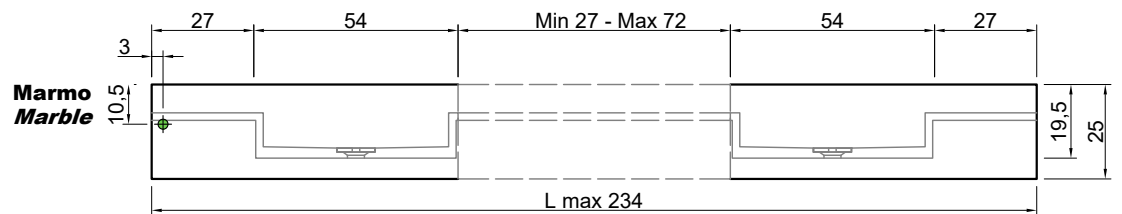

**Trooppieno automatico invisibile**  
Valido solo per la versione in Corian  
La piletta si apre automaticamente al raggiungimento del livello di sicurezza PREDEFINITO, permettendo all'acqua di defluire.

**Automatic invisible Overflow**  
Valid only for the Corian version  
The drain opens automatically when the PRESET safety level is reached allowing the water to drain away.

## STREET Consolle

Articolo: **STREET447 prof. 47 + N°2 STREET24772 prof. 47**

Materiale: Marmo o Corian

Troppo pieno: NO

**Descrizione:** Top con doppio lavabo integrato in Marmo o Corian con canale posteriore, con sistema di scarico predisposto per sifone. La versione in Corian presenta il sistema di piletta con troppopieno invisibile.

Article: **STREET447 prof. 47 + N°2 STREET24772 prof. 47**

Material: Marble or Corian

Overflow: NO

**Description:** Top with double integrated sink in Marble or Corian with back canal, with drain prepared for siphon. The Corian version features the drain system with an invisible automatic overflow.



**22** **LAVABO DOPPIO CON CANALE**  
**DOUBLE SINK WITH CANAL**  
**IN NICCHIA**  
**WITHIN WALLS**

 Alimentazione elettrica DC 12V  
Power supply DC 12V

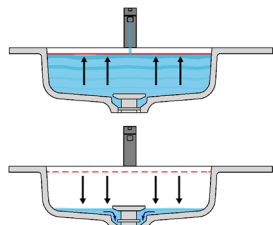
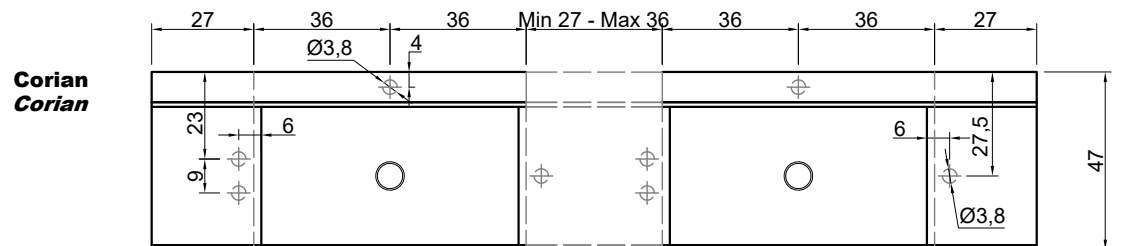
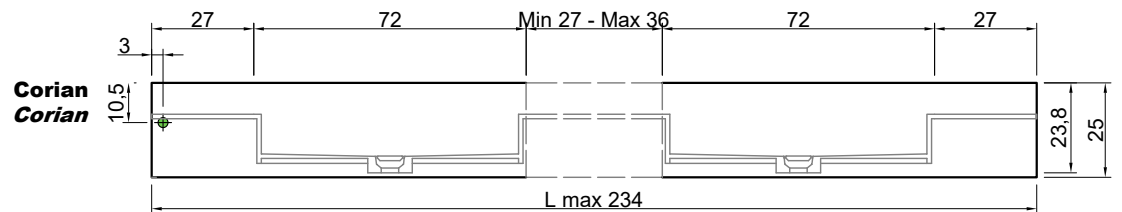
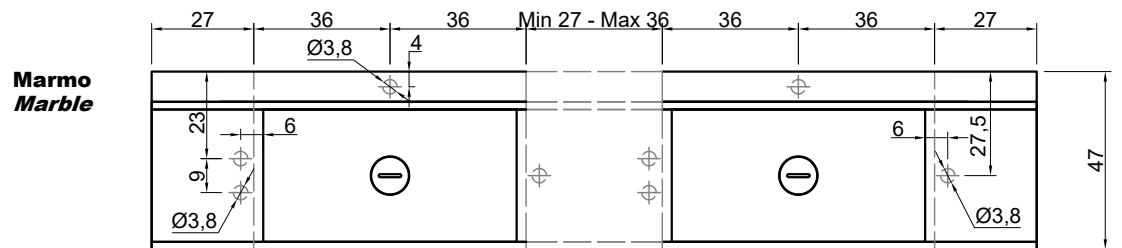
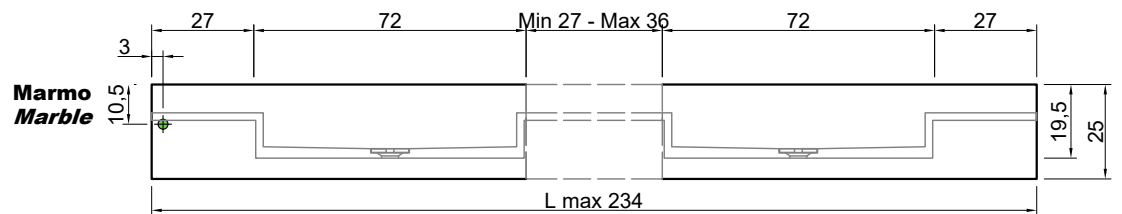

**Troppo pieno automatico invisibile**  
**Valido solo per la versione in Corian**  
La piletta si apre automaticamente al raggiungimento del livello di sicurezza PREDEFINITO, permettendo all'acqua di defluire.

**Automatic invisible Overflow**  
**Valid only for the Corian version**  
The drain opens automatically when the PRESET safety level is reached allowing the water to drain away.



## STREET Consolle

Articolo: **STREET347 prof. 47 + N°2 STREET24754 prof. 47**

Materiale: Marmo o Corian

Trooppieno: NO

**Descrizione:** Top con doppio lavabo integrato in Marmo o Corian con canale posteriore, con sistema di scarico predisposto per sifone. La versione in Corian presenta il sistema di piletta con trooppieno invisibile.

Article: **STREET347 prof. 47 + N°2 STREET24754 prof. 47**

Material: Marble or Corian

Overflow: NO

**Description:** Top with double integrated sink in Marble or Corian with back canal, with drain prepared for siphon. The Corian version features the drain system with an invisible automatic overflow.



23

**LAVABO DOPPIO CON CANALE  
DOUBLE SINK WITH CANAL  
A PARETE CON FIANCHI DI CHIUSURA  
WALL MOUNTED WITH CLOSED SIDES**



Alimentazione  
elettrica DC 12V  
Power supply DC 12V

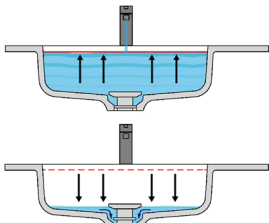
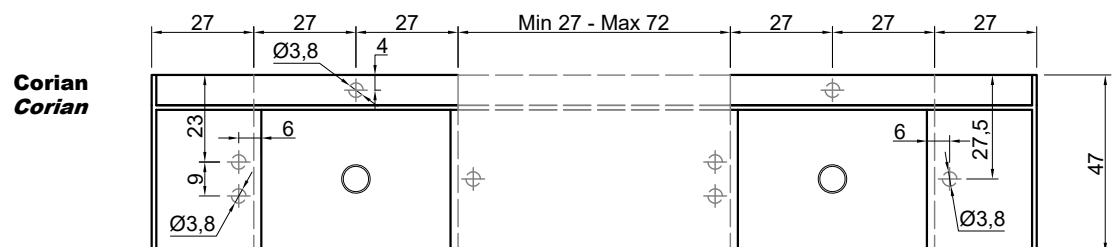
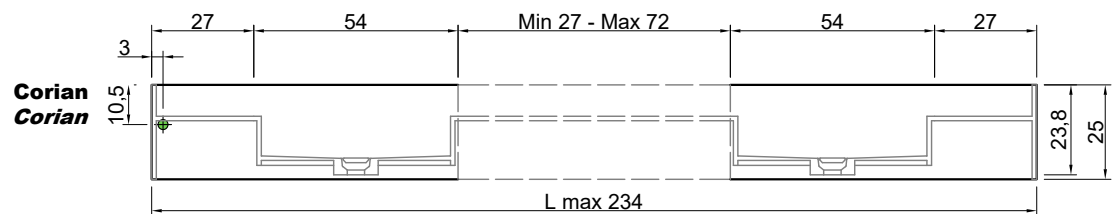
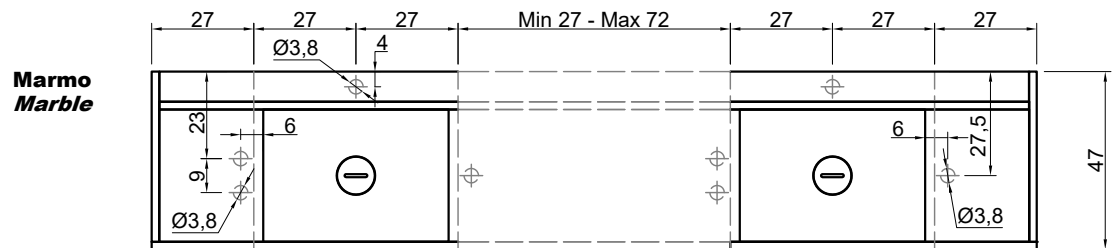
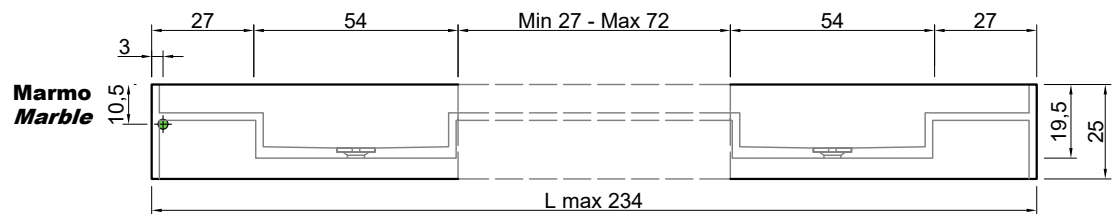

**Trooppieno automatico invisibile  
Valido solo per la versione in Corian**  
La piletta si apre automaticamente al raggiungimento del livello di sicurezza PREDEFINITO, permettendo all'acqua di defluire.

**Automatic invisible Overflow  
Valid only for the Corian version**  
The drain opens automatically when the PRESET safety level is reached allowing the water to drain away.



## STREET Consolle

Articolo: **STREET347 prof. 47 + N°2 STREET24772 prof. 47**

Materiale: Marmo o Corian

Trooppieno: NO

**Descrizione:** Top con doppio lavabo integrato in Marmo o Corian con canale posteriore, con sistema di scarico predisposto per sifone. La versione in Corian presenta il sistema di piletta con trooppieno invisibile.

Article: **STREET347 prof. 47 + N°2 STREET24772 prof. 47**

Material: Marble or Corian

Overflow: NO

**Description:** Top with double integrated sink in Marble or Corian with back canal, with drain prepared for siphon. The Corian version features the drain system with an invisible automatic overflow.



24

**LAVABO DOPPIO CON CANALE  
DOUBLE SINK WITH CANAL  
A PARETE CON FIANCHI DI CHIUSURA  
WALL MOUNTED WITH CLOSED SIDES**



Alimentazione  
elettrica DC 12V  
Power supply DC 12V

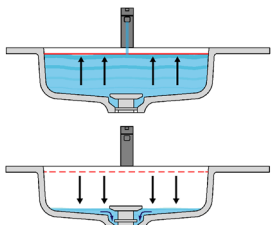
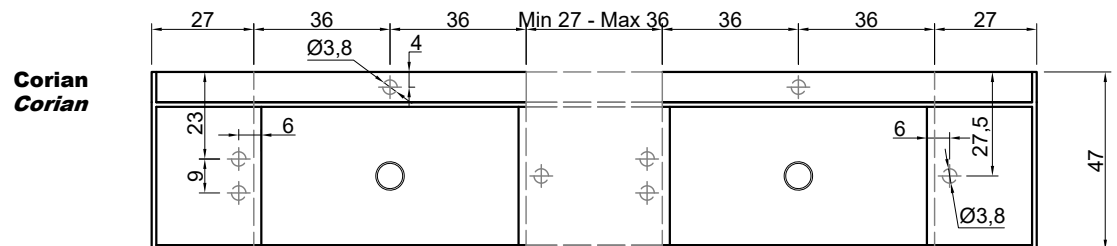
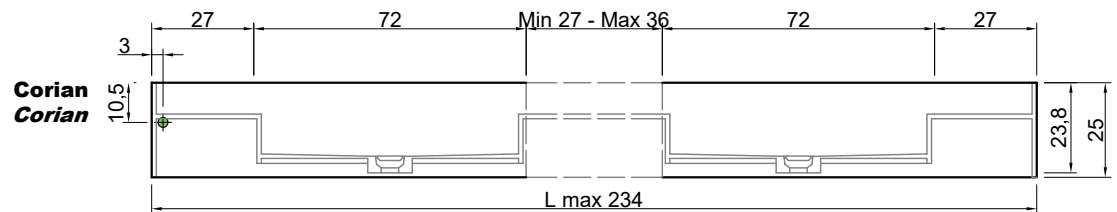
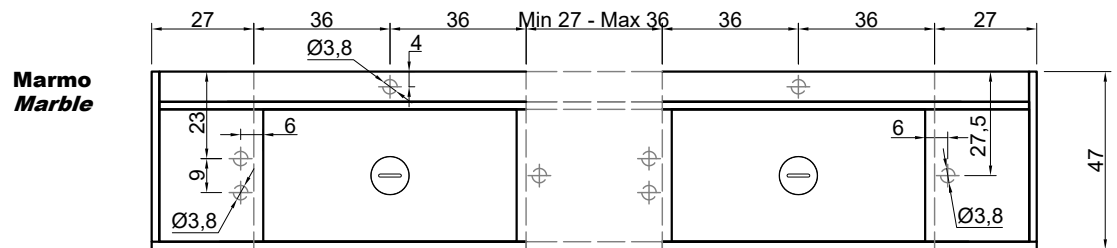
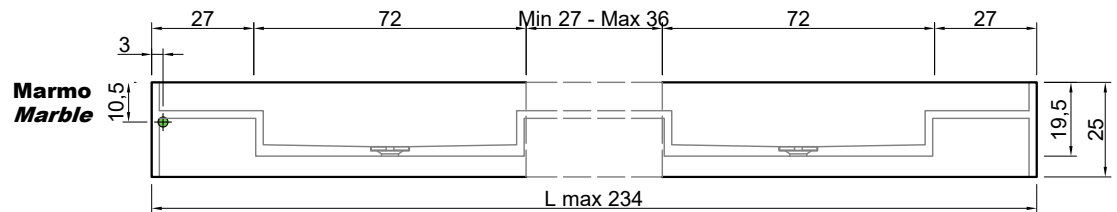

**Trooppieno automatico invisibile  
Valido solo per la versione in Corian**  
La piletta si apre automaticamente al raggiungimento del livello di sicurezza PREDEFINITO, permettendo all'acqua di defluire.

**Automatic invisible Overflow  
Valid only for the Corian version**  
The drain opens automatically when the PRESET safety level is reached allowing the water to drain away.

## MATERIALI IMPIEGATI

### Pietra naturale

Data la caratteristica naturale della pietra, ogni singolo pezzo può presentare venature, differenze di tonalità, intrusioni minerali, avvallature, stuccature.

I nostri prodotti vengono ricavati, tramite lavorazioni artigianali, da unici blocchi in pietra. Ogni tipo di pietra presenta un aspetto diverso per infinite varietà di venature e colori da blocco a blocco. Tali caratteristiche sono la conferma dell'utilizzo di materiali naturali e non possono dare adito a contestazioni.

## ISTRUZIONI PER L'USO E MANUTENZIONE

### PULIZIA

Al momento della posa in opera consigliamo un trattamento idrorepellente al fine di saturarne la porosità senza modificarne l'aspetto originario. Per il trattamento utilizzare il prodotto "Clean Stone", da noi fornito (vedi scheda prodotto).

Utilizzare il prodotto con un panno morbido o un pennello, trattare tutta la superficie interessata e lasciarlo agire per 30 minuti, ripetere l'operazione una seconda volta. Rimuovere eventuali residui di polvere con un panno asciutto.

Pulire con normali detersivi di tipo neutro a basso contenuto alcalino.

Si sconsiglia l'uso di prodotti aggressivi quali anticalcare, acidi, abrasivi, sgrassanti forti, alcool.

### ATOSSICITÀ

Il prodotto non risulta tossico o nocivo all'uomo, agli animali o all'ambiente.

### ECOLOGIA

Alla fine della sua utilizzazione non disperdere l'oggetto nell'ambiente, ma smaltirlo secondo le modalità previste dall'azienda comunale di smaltimento rifiuti.

## PRODUCT DESCRIPTION

## Stone

## MATERIALS USED

### Natural stone

Given the natural characteristics of the stone, each piece can present veins, tonality differences, mineral intrusion or stucco-work.

Our products are hand carved from single stone blocks each presenting a diverse aspect caused by a variety of veins and colors. Such characteristics confirm our use of natural material of which cannot give rise to disputes.

## USAGE AND MAINTENANCE INSTRUCTIONS

### CLEANING

Once installed, we advise a waterproofing treatment without modifying the original aspect.

For treatment use the product Clean Stone provided (see spec sheet). Apply with a soft cloth or brush, treat the entire surface and wait 30 minutes for the product to have taken effect after which apply the second coat. Remove eventual residue of dust with a dry cloth.

Clean with normal neutral detergents with a low alkaline content.

Not advisable are strong abrasive cleaners, grease or calcareous removers, acids and alcohol.

### TOXICITY

The product does not appear toxic to humans, animals or to the environment.

### ECOLOGY

Only discard in appropriate disposals according to rules and regulations in your area.

**Avvertenza:** la presente scheda prodotto ottempera alle disposizioni della legge del 10 aprile 1991 n. 126 "Norme per l'informazione del consumatore" e al Decreto del 8 febbraio 1997 n.101 "Regolamento d'attuazione"

**Warning:** The current product information complies with law n.126 of the 10th of April 1991 "Regulations for consumer information" and to ordinance n.101 of the 8th of February 1997 "Fulfillment Regulations"

## MATERIALI IMPIEGATI

### CORIAN®

Corian® è un materiale compatto e non poroso, composto in modo omogeneo da ± 1/3 di resina acrilica (conosciuta anche come Metracrilato di Polimetile o PMMA) e da ± 2/3 di sostanze minerali. Il componente principale è il Tri-idrato di Alluminio (ATH), un minerale derivato dalla bauxite, da cui viene estratto l'alluminio. Corian® è il materiale originale prodotto dalla DuPont per superfici solide.

Essendo solido ed omogeneo è facilmente riparabile, infatti possibile ripristinare piccole scalfiture con un apposito stucco bicomponente e togliere facilmente graffi, piccoli tagli e abrasioni con l'utilizzo di carta abrasiva, in modo da restituire al prodotto la sua bellezza originale. Molti danni dovuti da urti, calore o prodotti chimici possono essere riparati solitamente sul luogo ridando integralmente alla superficie il suo aspetto originale, regolare, igienico.

## ISTRUZIONI PER L'USO E MANUTENZIONE

### PULIZIA\*

Pulire con panno umido o comuni detergenti liquidi per la pulizia domestica. Sono particolarmente consigliati detergenti liquidi, quali CLEANSURFACE utilizzati con spugna abrasiva tipo SCOTCH BRITE®. Non utilizzare prodotti chimici aggressivi quali acetone, trielina, cloruro di metilene, diluenti di smalto per unghie, acidi e basi forti. Nel caso in cui venga macchiato con smalto per unghie bisogna far attenzione a non utilizzare un solvente a base di acetone che potrebbe danneggiare la superficie.

### PULIZIA RIVESTIMENTO LEGNO

Non usare prodotti comuni per la pulizia del legno che possono danneggiare la finitura opaca. Utilizzare esclusivamente il prodotto CLEAN WOOD da noi fornito. Versare il prodotto su un panno morbido e distribuirlo uniformemente sulla superficie da trattare. Non usare spugne abrasive.

### PULIZIA RIVESTIMENTO LACCATO

Pulire i mobili con panno morbido o spugna non abrasiva umida o con alcool etilico diluito. Tutte le operazioni devono essere effettuate con cura per non graffiare o lucidare la superficie.

### ATOSSICITÀ

Il prodotto non risulta tossico o nocivo all'uomo, agli animali o all'ambiente.

### ECOLOGIA

Alla fine della sua utilizzazione non disperdere l'oggetto nell'ambiente, ma smaltirlo secondo le modalità previste dall'azienda comunale di smaltimento rifiuti.

### AVVERTENZA

I lavabi, piatti doccia e vasche vanno posati in bolla.

### Guida per la rimozione delle macchie\*

Tipo di macchia	Procedura
Manutenzione giornaliera.	A. B. C. E.
Aceto, caffè, tè, succo di limone, olii vegetali, ketchup, residui di grasso, olio.	A. B. C. D.
Acqua ricca di calcare, sapone, minerali.	A. B. F.
Polline di giglio, zafferano, graffio significativo, bruciatura di sigaretta, lucido per scarpe, inchiostro, segno di penna	A. B. C. E.
Mercurocromo, sangue, vino rosso, profumo.	A. B. C. D. E.
Smalto per unghie.	A. B. C. G.
Ferro o ruggine.	A. B. C. H.
Iodio, muffa.	A. B. C. E.

**A** Rimuovere il residuo con panno

**B** Sciacquare la superficie con acqua calda e asciugare con panno morbido

**C** Usare un panno umido e una crema abrasiva leggera (es. Cif®)

**D** Usare una spugna abrasiva (tipo Scotch-Brite®) strofinare sulla macchia con un prodotto detergente a base di ammoniacca (es. Mastro Lindo)

**E** Usare una spugna abrasiva (tipo Scotch-Brite®) e strofinare sulla macchia con candeggina\*\*

**F** Usare una spugna abrasiva (tipo Scotch-Brite®) e strofinare sulla macchia con un prodotto di pulizia anticalcare (tipo Viakal®) o aceto. Sciacquare più volte con acqua calda ed asciugare con panno morbido

**G** Usare una spugna abrasiva (tipo Scotch-Brite®) e strofinare sulla macchia con un prodotto privo di acetone. Sciacquare più volte con acqua calda e asciugare con panno morbido

**H** Usare una spugna abrasiva (tipo Scotch-Brite®) e strofinare sulla macchia con una paglietta o rimuovere la ruggine. Sciacquare più volte con acqua calda e asciugare con un panno morbido

\* Pulire facendo sempre movimenti rotatori

\*\* La candeggina può scolorire il Corian® se non è rimossa completamente risciacquare con abbondante acqua

### PULIZIA SIFONE INTEGRATO DEI LAVABI

Pulire periodicamente il sifone integrato, per eliminare eventuali depositi

- Posizionare un contenitore sotto il sifone, in corrispondenza del tappo d'ispezione posizionato nella parte centrale del lavabo, per la raccolta dell'acqua sporca
- Svitare il tappo d'ispezione e far uscire completamente l'acqua dal sifone
- Far scorrere abbondante acqua calda nel lavabo, inserendo degli stracci nella fessura di scarico del lavabo: prima centralmente e poi lateralmente
- Riavvitare il tappo d'ispezione e far scorrere acqua nel lavabo in modo che la vaschetta del sifone si riempia nuovamente



## MATERIALS USED

### CORIAN®

Corian® is a solid, non-porous surfacing material homogeneously composed of  $\pm 1/3$  acrylic resin (also known as PolyMethyl MethAcrylate or PMMA), and  $\pm 2/3$  natural minerals. These minerals are composed of Aluminum TriHydrate(ATH) derived from bauxite, an ore from which aluminum is extracted. Corian® is the original material produced by DuPont for solid surfaces.

Being inherently "renewable" because it is solid and homogeneous all the way through. Most damages, including severe impact, heat or chemical damage, can usually be repaired on site to restore the original, smooth, hygienic solid surface integrity.

## USAGE AND MAINTENANCE INSTRUCTIONS

### CLEANING \*

Clean with a damp cloth or with common liquid detergents for domestic use. Particularly recommended are liquid detergents such as CIF® used with an abrasive sponge such as a SCOTCH BRITE® pad. Do not use aggressive chemical products such as acetone, trichloroethylene nor strong acids. Warning: Level sinks, shower trays and tubs.

### Cleaning of wood covering

Avoid using common products for cleaning the wood which can damage the matt finish. Use exclusively the CLEANWOOD product provided by our company. Use a damp cloth and distribute evenly over the surface to clean. Avoid the use of abrasive sponges.

### Cleaning of lacquered covering

Clean the furniture with a soft damp cloth or non abrasive sponge or with diluted acetyl alcohol. All cleaning should be done with great care so as not to scratch the surface.

### TOXICITY

The product does not appear toxic to humans, animals or to the environment. Only discard in appropriate disposals according to rules and regulations in your area.

### ECOLOGY

Only discard in appropriate disposals according to rules and regulations in your area.

### WARNING

The sinks, shower trays and tubs must be installed leveled.

Common household spills	Procedura
Everyday cleaning.	A. B. C. E.
Vinegar, coffee, tea, lemon juice, vegetable, dyes, ketchup, grease, fat and oil residues	A. B. C. D.
Water scale, soap, minerals.	A. B. F.
Pollen, saffron, a light scratch, cigarette burns, shoe polish, Ink, marker pen.	A. B. C. E.
Mercurochrome, blood, red wine, perfume.	A. B. C. D. E.
Nail varnish spills.	A. B. C. G.
Iron or rust.	A. B. C. H.
Iodine, mildew.	A. B. C. E.

**A** Remove excess with a soft cloth

**B** Rinse surface with warm water and dry with a soft cloth

**C** Use a damp cloth and a mild cream abrasive cleanser. (e.g. Jif active, Bar Keepers Friend);

**D** Use an abrasive plastic scouring pad (e.g. Scotch-Brite® type) and rub over the stain with detergent or an ammonia based hard-surface cleaner (e.g. Flash, Mr. Muscle, Comet)

**E** Use an abrasive plastic scouring pad (e.g. Scotch-Brite® type) and rub over the stain with some bleach\*\* (Javel). Rinse several times with warm water and dry with a soft cloth \*\*

**F** Use an abrasive plastic scouring pad (e.g. Scotch-Brite® type) and rub over the stain with standard household lime-scale remover or vinegar (e.g. Viakal type). Rinse several times with warm water and dry with a soft cloth

**G** Use an abrasive plastic scouring pad (e.g. Scotch-Brite® type) and rub over the stain with non-acetone based remover. Rinse several times with warm water and dry with a soft cloth

**H** Use an abrasive plastic scouring pad (e.g. Scotch-Brite® type) and rub over the stain with a metal cleaner or rust remover. Rinse several times with warm water and dry with a soft cloth

\* Clean using a circular motion

\*\* La candeggina può scolorire il Corian® se non è rimossa completamente risciacquare con abbondante acqua

### CLEANING INTEGRATED SIPHONS IN SINKS

Often clean the integrated siphon to eliminate any deposits.

- . Position a container under the sink in correspondence with the inspection cap positioned centered under the sink to capture dirty water.
- . Unscrew the inspection cap and completely empty the siphon.
- . Allow hot water to run through the sink and thoroughly clean the slit in the sink.
- . Screw back on the inspection cap and let water run to fill the siphon back up.

**ATTENZIONE**

Si declina ogni responsabilità relativa ad eventuali inesattezze contenute in queste istruzioni dovute ad errori di trascrizione.

**WARNING**

We decline all responsibility and eventual inaccuracy contained in the instructions due to transcript errors.

**ATTENTION**

Nous ne nous retenons pas responsable des erreurs éventuelles contenu dans ces instructions dues à une mauvaise transcription.

**ACHTUNG**

Für eventuelle Fehler bei der Übersetzung der technischen Liste weißt Antonio Lupi Design S.p.A jegliche Verantwortung von sich.

**ATENCIÓN**

Declinamos cualquier responsabilidad por eventuales inexactitudes contenidas en estas instrucciones debidas a errores de transcripción.

**ВНИМАНИЕ**

Компания снимает с себя любую ответственность за возможные неточности, содержащиеся в данных инструкциях и возникшие при перепечатке материалов.

# antoniolupi

## 73

VIA MAZZINI

## 75

Antonio Lupi Design S.p.A.  
via Mazzini 73/75 - 50050 Stabbia  
Cerreto Guidi (Firenze) - Italy  
T +39 0571 586881\_95651  
[www.antoniolupi.it](http://www.antoniolupi.it)  
[lupi@antoniolupi.it](mailto:lupi@antoniolupi.it)