



Bookshelf in solid wood with a fine iron frame, "irondust" anthracite grey lacquered, and shelving with natural edges that intersect and protrude from the structure.

STANDARD VERSION: IRON STRUCTURE LACQUERED IRONDUST COLOUR (B2), WHICH CAN BE DISASSEMBLED

ATTENTION: SHELVES AND FRAME MUST BE FIXED TO THE WALL (L-SHAPED METAL PLATES AT SIGHT).
FOR BOOKCASES LONGER THAN 200 CM, EACH SINGLE SHELF MUST BE COMPULSORY FIXED TO THE WALL WITH THE RELEVANT FIXING TOOL

CODE	SIZE	A1	A2	A3	A4	A6
CRAZY1	W.120 x D.37 x H.200	■	■	■	■	■
CRAZY2	W.160 x D.37 x H.200	■	■	■	■	■
CRAZY3	W.180 x D.37 x H.200	■	■	■	■	■
CRAZY3.1	W.200 x D.37 x H.200	■	■	■	■	■
CRAZY3.2	W.220 x D.37 x H.200	■	■	■	■	■
CRAZY3.3	W.240 x D.37 x H.200	■	■	■	■	■
CRAZY4	W.280 x D.37 x H.200	■	■	■	■	■

AVAILABLE FINISHES:

- A1:** walnut without knots, walnut with knots, elm
- A2:** oak without knots, oak with knots, cherry, maple
- A3:** oak without knots finish: whitened, mystic black, vintage, neutro
oak with knots finish: whitened, mystic black, vintage, neutro
- A4:** oak without knots pigmented: ash grey, white milk, total black
oak with knots pigmented: ash grey, white milk, total black
- A6:** briccola

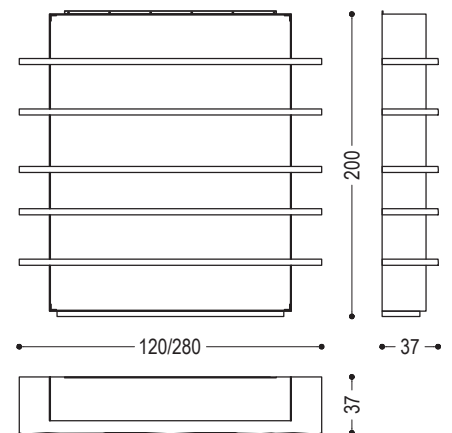

CRAZY

FEASIBILITY STRUCTURE IN LACQUERED IRON	CRAZY 1 - 2 - 3	CRAZY 3.1 - 3.2 - 3.3	CRAZY 4
B2	■	■	■
B3	■	■	■

AVAILABLE FINISHES:

B2: lacquered iron: iron dust, RAL (only selected colours)

B3: lacquered iron matt brushed effect: aged copper, aged bronze, stainless steel, titanium
lacquered iron oxidised effect

CRAZY | AVAILABLE FINISHES

WOOD

A1



walnut without knots



walnut with knots



elm

A2



oak without knots



oak with knots



cherry



maple

A3



oak without knots finish:
whitened



oak without knots finish:
mystic black



oak without knots finish:
vintage



oak without knots finish:
neutro



oak with knots finish:
whitened



oak with knots finish:
mystic black



oak with knots finish:
vintage



oak with knots finish:
neutro

A4



oak without knots pigmented:
ash grey



oak without knots pigmented:
white milk



oak without knots pigmented:
total black



oak with knots pigmented:
ash grey



oak with knots pigmented:
white milk



oak with knots pigmented:
total black











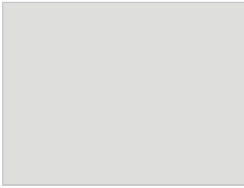

A6

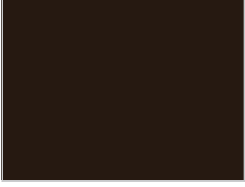
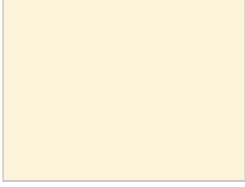
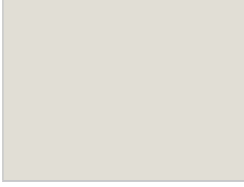

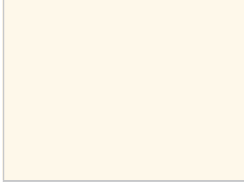
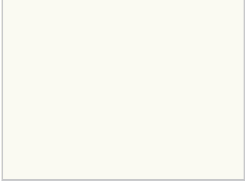
briccola

CRAZY | AVAILABLE FINISHES

IRON

B2					
	lacquered iron: iron dust	ferro laccato: RAL - 1013_OYSTER WHITE	ferro laccato: RAL - 3020_TRAFFIC RED	ferro laccato: RAL - 7035_LIGHT GREY	ferro laccato: RAL - 7037_DUSTY GREY
					
	ferro laccato: RAL - 8019_GREY BROWN	ferro laccato: RAL - 9001_CREAM WHITE	ferro laccato: RAL - 9002_GREY WHITE	ferro laccato: RAL - 9005_JET BLACK	ferro laccato: RAL - 9010_PURE WHITE
					
	ferro laccato: RAL - 9016_TRAFFIC WHITE				
B3					
	lacquered iron, matt brushed effect: aged copper	lacquered iron, matt brushed effect: aged bronze	lacquered iron, matt brushed effect: stainless steel	lacquered iron, matt brushed effect: titanium	lacquered iron, oxidised effect