



Table with top made of solid wood, consisting of two single planks aligned, with middle gap and natural sides. Upon request available with asymmetrical planks, disaligned of 30 cm (Bedrock Plank B). Base in iron plate characterised by geometric lines.

CODE	SIZE	BASE	A1	A2	A4
BEDROCK-PLANK.DIR	W.200 x D.90/100 x H.76	B2	■	■	■
		B3	■	■	■
BEDROCK-PLANK 1.DIR	W.220 x D.90/100 x H.76	B2	■	■	■
		B3	■	■	■
BEDROCK-PLANK 2.DIR	W.240 x D.90/100 x H.76	B2	■	■	■
		B3	■	■	■
BEDROCK-PLANK 3.DIR	W.260 x D.90/100 x H.76	B2	■	■	■
		B3	■	■	■
BEDROCK-PLANK 4.DIR	W.280 x D.90/100 x H.76	B2	■	■	■
		B3	■	■	■
BEDROCK-PLANK 5.DIR	W.300 x D.90/100 x H.76	B2	■	■	■
		B3	■	■	■

AVAILABLE FINISHES:

- A1:** walnut with knots
- A2:** oak with knots
- A4:** oak without knots pigmented: white milk
oak with knots pigmented: white milk, total black
- B2:** lacquered iron: iron dust, RAL (only selected colours)
- B3:** lacquered iron matt brushed effect: aged bronze, stainless steel, titanium

BEDROCK-PLANK C

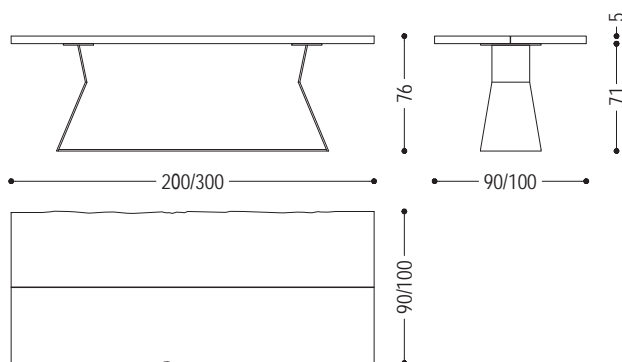

BEDROCK-PLANK B

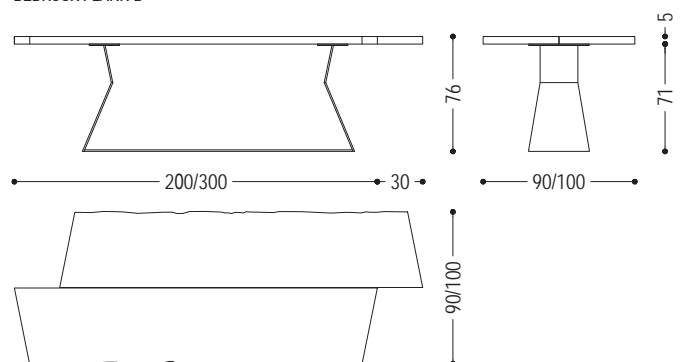

BEDROCK PLANK C | AVAILABLE FINISHES

WOOD

A1



walnut with knots

A2



oak with knots

A4



oak without knots pigmented:
white milk



oak with knots pigmented:
white milk



oak with knots pigmented:
total black

IRON

B2

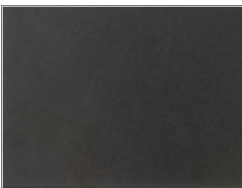

lacquered iron:
iron dust

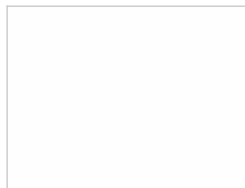

ferro laccato:
RAL - 1013_OYSTER WHITE

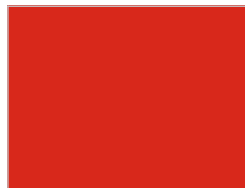

ferro laccato:
RAL - 3020_TRAFFIC RED

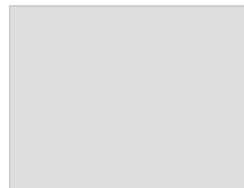

ferro laccato:
RAL - 7035_LIGHT GREY

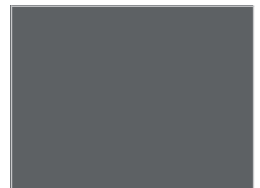

ferro laccato:
RAL - 7037_DUSTY GREY

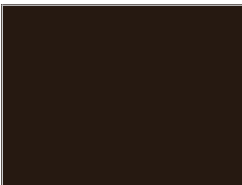

ferro laccato:
RAL - 8019_GREY BROWN

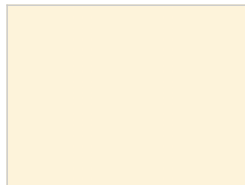

ferro laccato:
RAL - 9001_CREAM WHITE

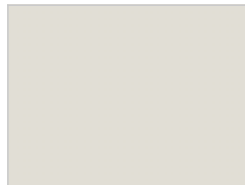

ferro laccato:
RAL - 9002_GREY WHITE

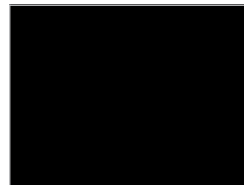

ferro laccato:
RAL - 9005_JET BLACK

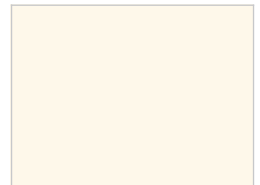

ferro laccato:
RAL - 9010_PURE WHITE



ferro laccato:
RAL - 9016_TRAFFIC WHITE

BEDROCK PLANK C | AVAILABLE FINISHES

B3

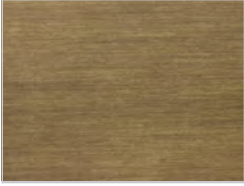

lacquered iron, matt brushed effect:
aged bronze



lacquered iron, matt brushed effect:
stainless steel

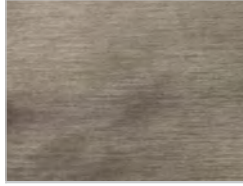

lacquered iron, matt brushed effect:
titanium