

mdf italia



© COPYRIGHT 2023 MDF ITALIA SRL SOCIETA' UNIPERSONALE

2016 - 2019

TENSE MATERIAL STONE

Designed by Piergiorgio Cazzaniga, Michele Cazzaniga

“A smart beauty, resulting from a thought and a know-how capable of transmitting a deep emotion through a wise accentuation of the peculiarities of the materials used”. Tense Material collection is available in 5 heights and 36 sizes, 170 typologies to meet different market needs, from residential to business spaces.

Raw materials' resistance and uniqueness.

A mix of natural and industrial materials give birth to TENSE MATERIAL made of STONE: its natural and smooth surface features irregular shades, typical of sedimentary stones.

The reconstructed stone finishes (white calce, black slate and the new pink and yellow onyx), obtained from mineral mixtures of marble and quartz, are applied by hand over the entire surface of the table, creating unique shades that are different for each table.

The material essence of the finishes is enhanced by the essentiality and linearity of Tense, characteristics that make this design icon perfect in any context and with any furnishing style.

Thanks to the possibility of equipping tables with the top-access, Tense Material in stone is also suitable for workplaces, adapting to any office style.

[EXPLORE THE WHOLE TENSE COLLECTION](#)

FRAME AND TOPS

35x35 mm steel legs with internal structural tie-rod. The 35 mm thick tabletop is a load-bearing composite board built with an internal frame consisting of either aluminium profiles and polystyrene filler, except for the brass top which has an acrylic resin honeycomb filling covered with two outer layers of aluminium.

TOP-ACCESS

The tables are also available in the version equipped with 1 or 2 top-access and under top cable tray. The metal cable trays are telescopic (H7/H10 cm), to host various wiring systems, such multi-scocket boxes, etc. wiring systems and electrical parts are not included.

The top-access is made of aluminium (L350 D127 mm) and it's available in three versions: single lead with soft closing (A version), double lead (B version), optional, single lead with soft closing, with inlay in the same finish of the table (C version). Available in: matt white lacquered for the tables in reconstructed stone white Calce, pink onyx and yellow. Matt black lacquered for the tables in all other versions.

DIMENSIONS

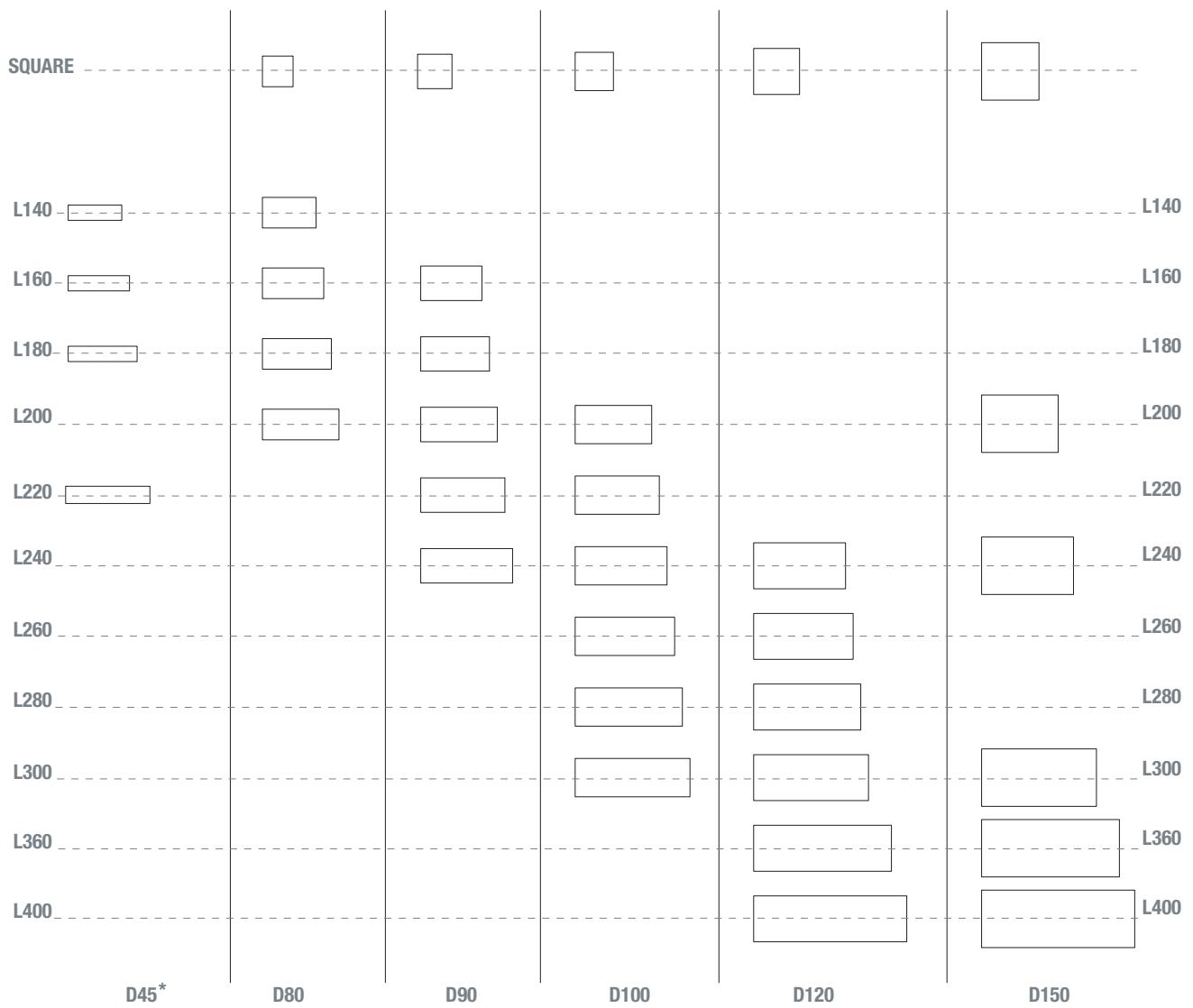
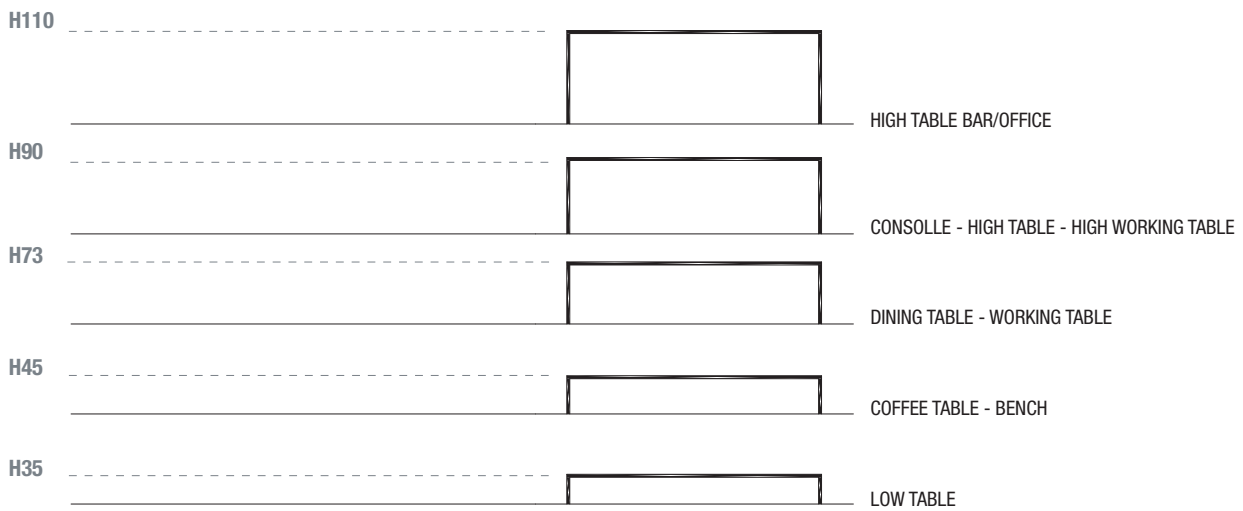

TYPE OF TOP-ACCESS L35 X H12.7 CM

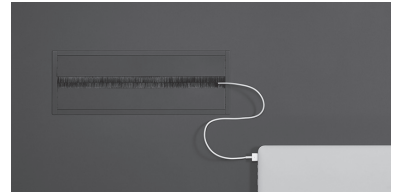
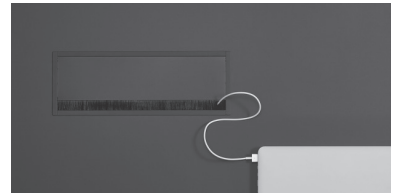
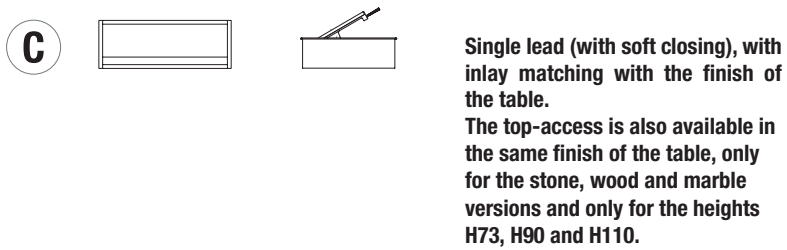
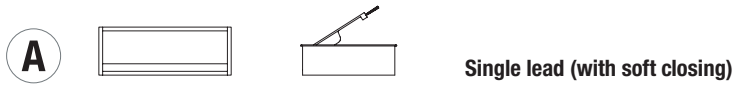

TYPE OF METAL WIREWAY (TELESCOPIC)

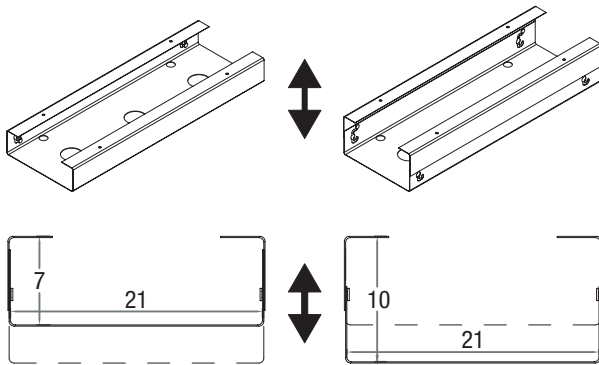

The metal cable trays are telescopic (H7/10 cm).

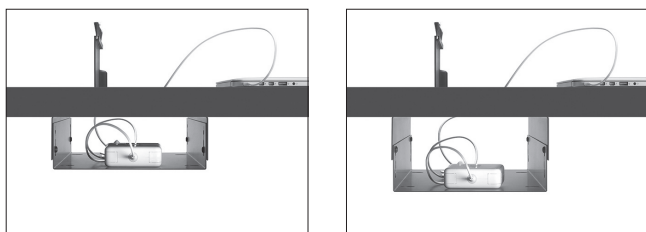

POSITION OF THE TOP-ACCESS

With one or two lateral top-access

X (cm)	Y (cm)
90	160
90	180
90	200
90	220
100	200
100	220

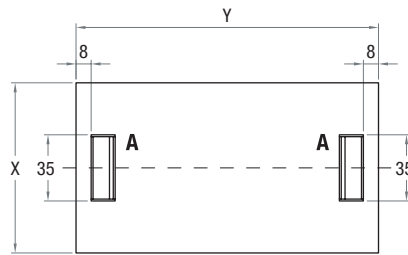

With one central top-access

X (cm)	Y (cm)
150	150
150	200
150	240

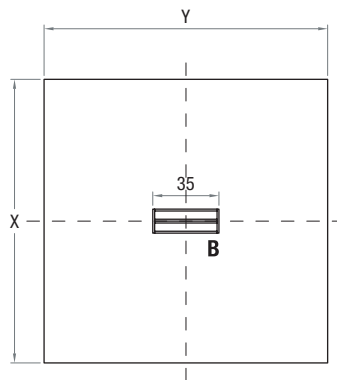

With two front top-access

X (cm)	Y (cm)	L (cm)
90	240	52
100	240	52
100	260	64
100	280	84
100	300	104
120	240	52
120	260	64
120	280	84
120	300	104
120	360	164
120	400	116

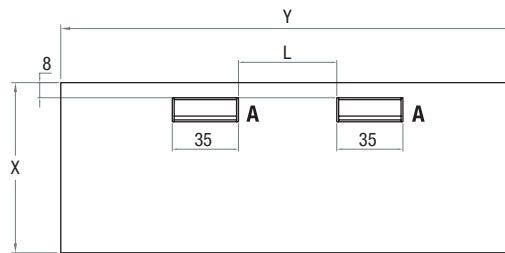

With two central top-access

X (cm)	Y (cm)	L (cm)
120	240	52
120	260	64
120	280	84
120	300	104
120	360	164
120	400	116
150	300	104
150	360	164
150	400	116

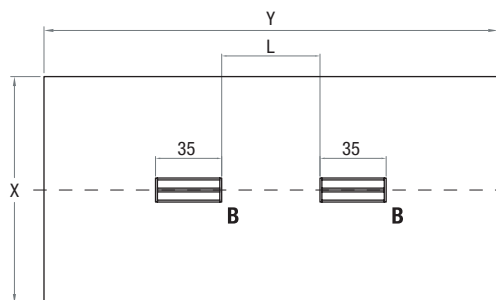

EXAMPLE OF TOP-ACCESS AND METAL WIREWAY POSITION

With one or two lateral top-access

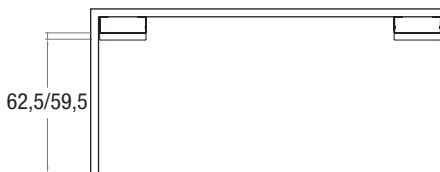
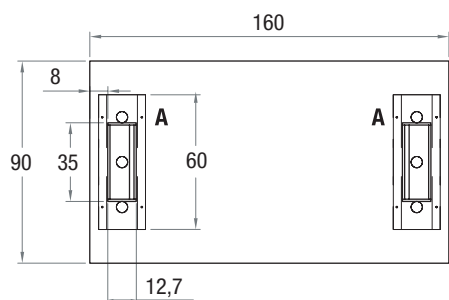

With two front top-access

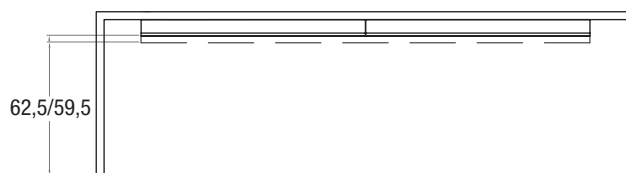
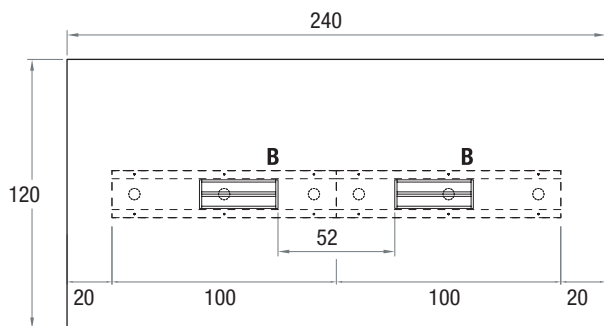

Finishing

The number in the dot corresponds to the number of colour/material finish.

Here below, in the section FINISH OPTIONS, please note all the colours of the materials used for this product.

TABLE

Top/Structure



Reconstructed stone

Finish options

TOP/STRUCTURE

Reconstructed stone



Reconstructed
stone pink
onyx X134
new



Reconstructed
stone yellow
onyx X133
new



Pietra serena
X084



Reconstructed
stone white
Calce X131



Reconstructed
stone black
slate X132