



---

Sideboard in solid wood and blockboard, with thin structure. Drawers assembled with dovetail joints and doors, with grooved handles. Thin iron legs.

**STANDARD COMPOSITION:** 4 DRAWERS - 4 DOORS - 4 ADJUSTABLE SHELVES

**ADDITIONAL ACCESSORIES:** SEE TECHNICAL NOTES

---

# KYOTO 2.0

STANDARD VERSION: IRON BASE MATT TRANSPARENT LACQUERED (B2); GROOVED HANDLES

CODE	SIZE	A1	A2	A3	A5
KYOTO 2.0	W.233,4 x D.45 x H.75	■	■	■	■

**AVAILABLE FINISHES:**

- A1:** walnut without knots, elm
- A2:** oak without knots, cherry, maple
- A3:** oak without knots finish: whitened, mystic black, neutro
- A5:** oak: with knots tabacco

FEASIBILITY STRUCTURE OPTIONS	
A4	■

**AVAILABLE FINISHES:**

- A4:** oak without knots pigmented: ash grey, white milk, total black

FEASIBILITY DRAWERS FRONTS OPTIONS	
A4	■

**AVAILABLE FINISHES:**

- A4:** oak without knots pigmented: ash grey, white milk, total black

FEASIBILITY DOORS OPTIONS	
A4	■

**AVAILABLE FINISHES:**

- A4:** oak without knots pigmented: ash grey, white milk, total black







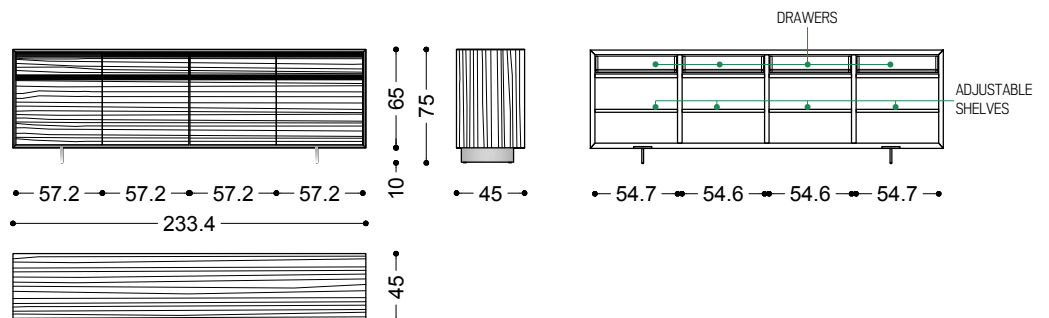





FEASIBILITY IRON FEET	
B2	■
B3	■

**AVAILABLE FINISHES:**









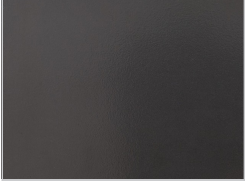
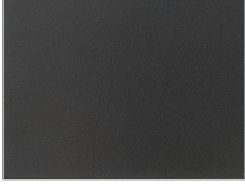
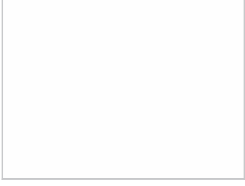

- B2:** lacquered iron: matt transparent, iron dust, RAL (only selected colours)
- B3:** lacquered iron matt brushed effect: aged copper, aged bronze, stainless steel, titanium  
lacquered iron oxidised effect

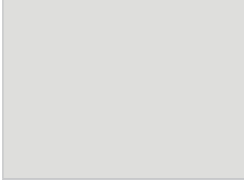

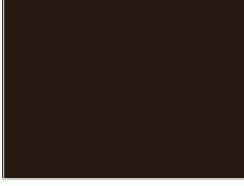
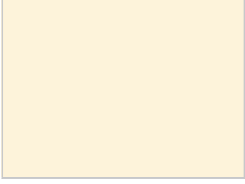
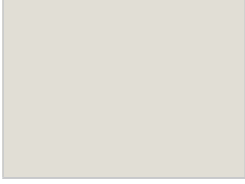
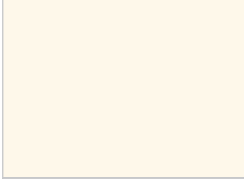
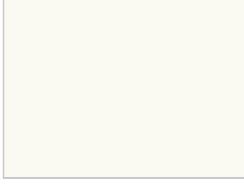
## WOOD

A1			
A2			
A3			
A4			
A5			

## IRON

B2					
	lacquered iron: matt transparent	lacquered iron: iron dust			
					
	ferro laccato: RAL - 1013_OYSTER WHITE	ferro laccato: RAL - 3020_TRAFFIC RED	ferro laccato: RAL - 7035_LIGHT GREY	ferro laccato: RAL - 7037_DUSTY GREY	ferro laccato: RAL - 8019_GREY BROWN
					
	ferro laccato: RAL - 9001_CREAM WHITE	ferro laccato: RAL - 9002_GREY WHITE	ferro laccato: RAL - 9005_JET BLACK	ferro laccato: RAL - 9010_PURE WHITE	ferro laccato: RAL - 9016_TRAFFIC WHITE
B3					
	lacquered iron, matt brushed effect: aged copper	lacquered iron, matt brushed effect: aged bronze	lacquered iron, matt brushed effect: stainless steel	lacquered iron, matt brushed effect: titanium	lacquered iron, oxidised effect

# PIECES OF FURNITURE | TECHNICAL NOTES

## DOORS AND DRAWERS OPENING SYSTEM

Add the following surcharge in case of non-standard opening system for drawers and doors.

SURCHARGE (price for one door/drawer)	
push-pull system	■
grooved handle	■

## CUTLERY TRAY

Trays can be customized upon request: feasibility and surcharge need to be confirmed by our sales department.  
Available finishes: walnut, oak, cherry, maple and elm.

CUTLERY DIVIDERS	
PP001 - for drawer W. 30 cm	■
PP002 - for drawer W. 60 cm	■
PP003 - for drawer W. 90 cm	■

### N.B.:

Cutlery dividers laid in the drawer.

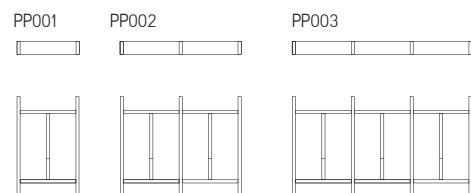

CUTLERY TRAY	
PP004 - for drawer W. 30 cm	■
PP005 - for drawer W. 60 cm	■
PP006 - for drawer W. 90 cm	■

### N.B.:

Cutlery tray with lateral handles for easy use.

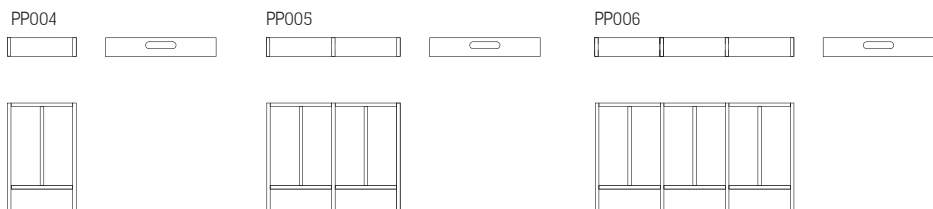

CUTLERY TRAY WITH CUTTING BOARD	
PPT001 - for drawer W. 60 cm	■

### N.B.:

Cutlery tray with lateral handles for easy use, composed by: cutlery dividers, beech cutting board and knives holder.

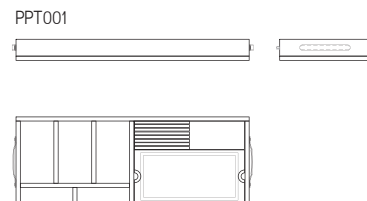

TRAY FOR FAR EAST ACCESSORIES	
SS001 - for drawer W. 60 cm	■

### N.B.:

Set with dividers for far east kitchen with lateral handles for easy use.

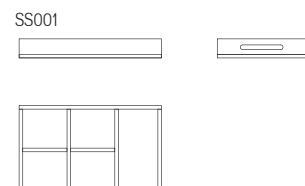

## DRAWER DIVIDERS

### WINE SET

Set for drawer with accessories for wine tasting (professional corkscrew, spare tips, steel cap, thermometer, pourer, drip ring, foil cutter).

Size W.29,5 x D.22,5 cm.

WINE SET	
walnut/oak	■
teak	■



### SPIRITS SET

Set for drawer with accessories for spirits tasting (4 small glasses and 4 marble chilling cubes).

Size W.20 x D.22,5 cm.

SPIRITS SET	
walnut/oak	■



## BOTTLE SPACES

Wooden grid for space with size W.56 x H.35 cm; depth of the grid around 33 cm.

Characterized by 9 spaces around 9x9 cm each, for bottles positioned horizontally, and one vertical module around W.19 x H.31 cm.

The grid can be customized upon request: feasibility and surcharge to be confirmed by our sales department.

BOTTLE SPACES	
walnut/oak	■



## GLASS HOLDERS

Composed by 3 stainless steel holders.

Holders L. 32 cm can hold max. 3 glasses with diameter of 8,5 cm, while holders L. 46,6 cm max. 4 glasses.

This set needs to be fixed to the top shelf or to another fixed shelf.

For more details please check the technical drawing.

Upon request:

- available in other sizes.
- position of the 3 elements at different distance.

GLASS HOLDERS	
set 3 elements L.32 cm	■
set 3 element L.46,6 cm	■

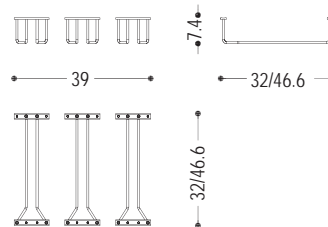

GLASS HOLDER ELEMENTS

