



**ADAPT**  
LOUNGE

Flexible, inviting and productive, the Adapt collection of lounges and accessories are designed to evolve with the dynamic needs of today's workspace. The clean lines and subtle surfaces of the Adapt Lounge bring a softness and sense of familiarity into the workspace. Designed to sit alone or combine in module configurations - arms, backs, screens, desks and tables can be added simply and easily.

A truly modular system with functionality at its core, Adapt caters for offices, receptions, universities, airports and hospitality spaces.

Adapt Lounges are made in Melbourne and fully GECA certified - FFG-200026. Under GECA, products are certified against environmental performance criteria across its life cycle to ensure they deliver better environmental outcomes.

**AVAILABLE UPHOLSTERY**

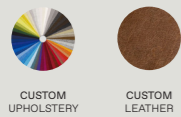

**AVAILABLE LEG FINISHES**



**DIMENSIONS**

**ADAPT OTTOMAN**

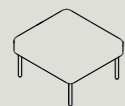

AO1  
W 725 D 680 H 440  
W 28.5" D 26.8" H 17.3"

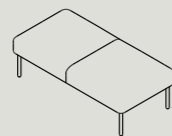

AO2  
W 1360 D 680 H 440  
W 53.5" D 26.8" H 17.3"

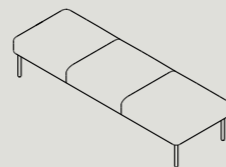

AO3  
W 2040 D 680 H 440  
W 80.3" D 26.8" H 17.3"

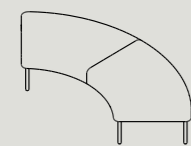

AO90  
W 1480 D 1480 H 440  
IN Ø1600 / OUT Ø2960  
W 58.3" D 58.3" H 17.3"  
IN Ø63.0" / OUT Ø116.5"



AO60  
W 1610 D 1265 H 440  
IN Ø2400 / OUT Ø3760  
W 63.4" D 49.8" H 17.3"  
IN Ø94.5" / OUT Ø148.0"

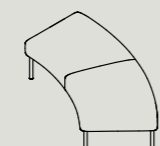

AO45  
W 1610 D 1115 H 440  
IN Ø3300 / OUT Ø4660  
W 63.4" D 43.9" H 17.3"  
IN Ø129.9" / OUT Ø183.5"

**ADAPT LOW-BACK WITH BACK ONLY**

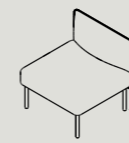

AB1\*  
W 725 D 730 H 700 S 440  
W 28.5" D 28.7" H 27.6" S17.3"

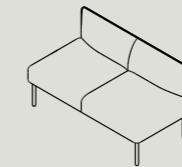

AB2\*  
W 1360 D 730 H 700 S 440  
W 53.5" D 28.7" H 27.6" S17.3"

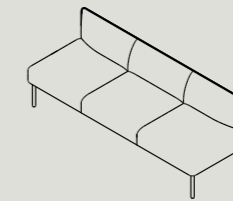

AB3\*  
W 2040 D 730 H 700 S 440  
W 80.3" D 28.7" H 27.6" S17.3"

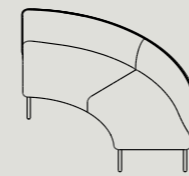

AB90  
W 1530 D 1530 H 700 S 440  
IN Ø1600 / OUT Ø3040  
W 60.2" D 60.2" H 27.6" S17.3"  
IN Ø63.0" / OUT Ø119.7"

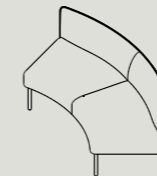

AB60  
W 1660 D 1315 H 700 S 440  
IN Ø2400 / OUT Ø3860  
W 65.4" D 51.8" H 27.6" S17.3"  
IN Ø94.5" / OUT Ø152.0"

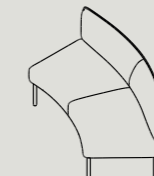

AB45  
W 1660 D 1165 H 700 S 440  
IN Ø3300 / OUT Ø4760  
W 65.4" D 45.9" H 27.6" S17.3"  
IN Ø129.9" / OUT Ø187.4"

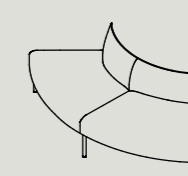

AB90-R  
W 1480 D 1480 H 700 S 440  
IN Ø1500 / OUT Ø2960  
W 58.3" D 58.3" H 27.6" S17.3"  
IN Ø59.1" / OUT Ø116.5"

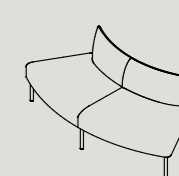

AB60-R  
W 1610 D 1315 H 700 S 440  
IN Ø2300 / OUT Ø3760  
W 63.4" D 51.8" H 27.6" S17.3"  
IN Ø90.6" / OUT Ø148.0"

**ADAPT LOW-BACK WITH SINGLE ARM / CORNER**

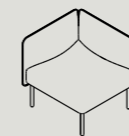

AC1\*  
W 730 D 730 H 700 S 440  
W 28.7" D 28.7" H 27.6" S17.3"

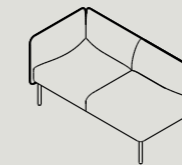

AA2-R/L\*\*  
W 1410 D 730 H 700 S 440  
W 55.5" D 28.7" H 27.6" S17.3"

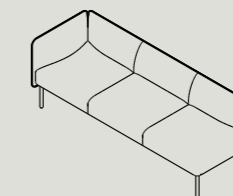

AA3-R/L\*\*  
W 2090 D 730 H 700 S 440  
W 82.3" D 28.7" H 27.6" S17.3"

**ADAPT LOW-BACK WITH SINGLE ARM**

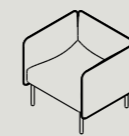

AL1  
W 825 D 730 H 700 S 440  
W 32.5" D 28.7" H 27.6" S17.3"

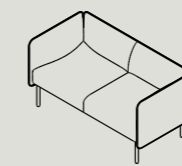

AL2  
W 1460 D 730 H 700 S 440  
W 57.5" D 28.7" H 27.6" S17.3"

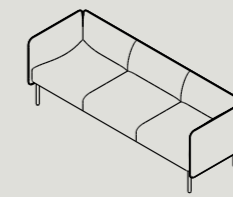

AL3  
W 2140 D 730 H 700 S 440  
W 84.25" D 28.7" H 27.6" S17.3"

\*R OR L REFERS TO RIGHT OR LEFT ARM LOCATION. ARM LOCATION IS DEFINED WHILE SITTING ON LOUNGE. DIMENSIONS SHOWN ARE INDICATIVE. FOR PROJECTS REQUIRING SPECIFIC DIMENSIONS, PLEASE GET IN CONTACT.

ADAPT MID-BACK WITH BACK ONLY

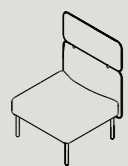

AMB1\*  
W 725 D 730 H 1025 S 440  
W 28.5" D 28.7" H 40.4" S17.3"



AMB2\*  
W 1360 D 730 H 1025 S 440  
W 53.5" D 28.7" H 40.4" S17.3"

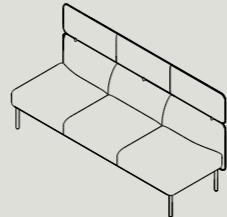

AMB3\*  
W 2040 D 730 H 1025 S 440  
W 80.3" D 28.7" H 40.4" S17.3"

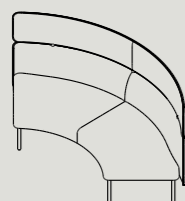

AMB90  
W 1530 D 1530 H 1025 S 440  
IN Ø1600 / OUT Ø3040  
W 60.2" D 60.2" H 40.4" S17.3"  
IN Ø63.0" / OUT Ø119.7"

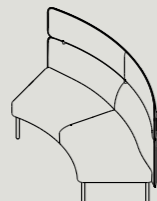

AMB60  
W 1660 D 1315 H 1025 S 440  
IN Ø2400 / OUT Ø3860  
W 65.4" D 51.8" H 40.4" S17.3"  
IN Ø94.5" / OUT Ø152.0"

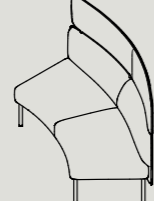

AMB45  
W 1660 D 1165 H 1025 S 440  
IN Ø3300 / OUT Ø4760  
W 65.4" D 45.9" H 40.4" S17.3"  
IN Ø129.9" / OUT Ø187.4"

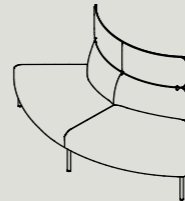

AMB90-R  
W 1480 D 1480 H 1025 S 440  
IN Ø1500 / OUT Ø2960  
W 58.3" D 58.3" H 40.4" S17.3"  
IN Ø59.1" / OUT Ø116.5"

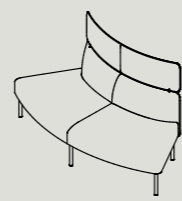

AMB60-R  
W 1610 D 1315 H 1025 S 440  
IN Ø2300 / OUT Ø3760  
W 63.4" D 51.8" H 40.4" S17.3"  
IN Ø90.6" / OUT Ø148.0"

ADAPT MID-BACK WITH SINGLE ARM / CORNER

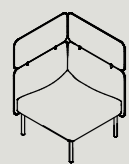

AMC1\*  
W 730 D 730 H 1025 S 440  
W 28.7" D 28.7" H 40.4" S17.3"

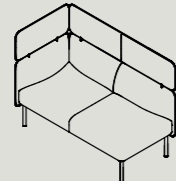

AMA2-R/L\*\*  
W 1410 D 730 H 1025 S 440  
W 55.5" D 28.7" H 40.4" S17.3"

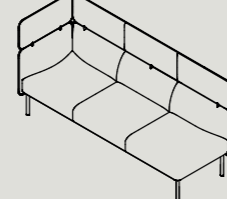

AMA3-R/L\*\*  
W 2090 D 730 H 1025 S 440  
W 82.3" D 28.7" H 40.4" S17.3"

ADAPT MID-BACK LOUNGE

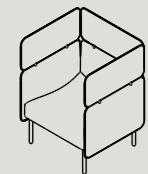

AML1  
W 825 D 730 H 1025 S 440  
W 32.5" D 28.7" H 40.4" S17.3"

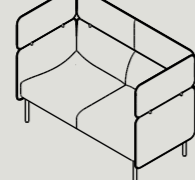

AML2  
W 1460 D 730 H 1025 S 440  
W 57.5" D 28.7" H 40.4" S17.3"

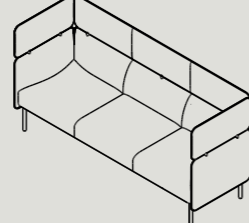

AML3  
W 2140 D 730 H 1025 S 440  
W 84.25" D 28.7" H 40.4" S17.3"

ADAPT HIGH-BACK WITH BACK ONLY (SINGLE SCREEN)

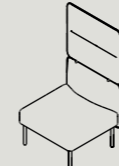

AHB1-S\*  
W 725 D 730 H 1350 S 440  
W 28.5" D 28.7" H 53.1" S17.3"

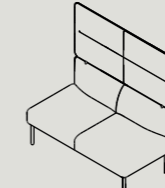

AHB2-S\*  
W 1360 D 730 H 1350 S 440  
W 53.5" D 28.7" H 53.1" S17.3"

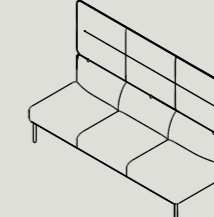

AHB3-S\*  
W 2040 D 730 H 1350 S 440  
W 80.3" D 28.7" H 53.1" S17.3"

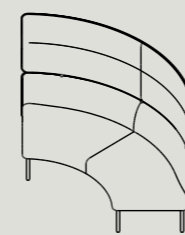

AHB90-S  
W 1530 D 1530 H 1350 S 440  
IN Ø1600 / OUT Ø3,040  
W 60.2" D 60.2" H 53.1" S17.3"  
IN Ø63.0" / OUT Ø119.7"



AHB60-S  
W 1660 D 1315 H 1350 S 440  
IN Ø2400 / OUT Ø3,860  
W 65.4" D 51.8" H 53.1" S17.3"  
IN Ø94.5" / OUT Ø152.0"

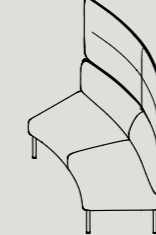

AHB45-S  
W 1660 D 1165 H 1350 S 440  
IN Ø3300 / OUT Ø4760  
W 65.4" D 45.9" H 53.1" S17.3"  
IN Ø129.9" / OUT Ø187.4"

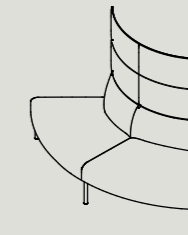

AHB90-R-S  
W 1480 D 1480 H 1350 S 440  
IN Ø1500 / OUT Ø2,960  
W 58.3" D 58.3" H 53.1" S17.3"  
IN Ø59.1" / OUT Ø116.5"

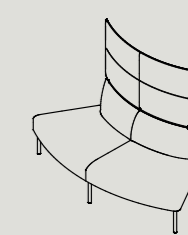

AHB60-R-S  
W 1610 D 1315 H 1350 S 440  
IN Ø2300 / OUT Ø3,760  
W 63.4" D 51.8" H 53.1" S17.3"  
IN Ø90.6" / OUT Ø148.0"

ADAPT HIGH-BACK WITH SINGLE ARM / CORNER (SINGLE SCREEN)



AHC1-S\*  
W 730 D 730 H 1350 S 440  
W 28.7" D 28.7" H 53.1" S17.3"



AHA2-S-R/L\*\*  
W 1410 D 730 H 1350 S 440  
W 55.5" D 28.7" H 53.1" S17.3"

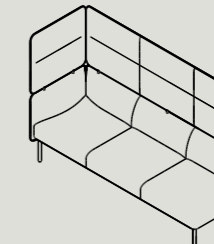

AHA3-S-R/L\*\*  
W 2090 D 730 H 1350 S 440  
W 82.3" D 28.7" H 53.1" S17.3"

ADAPT HIGH-BACK LOUNGE (SINGLE SCREEN)

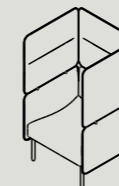

AHL1-S  
W 825 D 730 H 1350 S 440  
W 32.5" D 28.7" H 53.1" S17.3"



AHL2-S  
W 1460 D 730 H 1350 S 440  
W 57.5" D 28.7" H 53.1" S17.3"

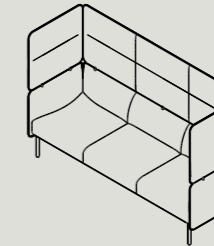

AHL3-S  
W 2140 D 730 H 1350 S 440  
W 84.25" D 28.7" H 53.1" S17.3"

\*R OR L REFERS TO RIGHT OR LEFT ARM LOCATION. ARM LOCATION IS DEFINED WHILE SITTING ON LOUNGE.  
#HIGH-BACK MODULES SHOULD BE SUPPORTED FROM BOTH ENDS, ACHIEVED THROUGH JOINING TO OTHER MODULES IN AN 'L' OR LINEAR CONFIGURATION.  
ALTERNATIVELY, ANGLED REAR LEGS WILL NEED TO BE USED  
DIMENSIONS SHOWN ARE INDICATIVE. FOR PROJECTS REQUIRING SPECIFIC DIMENSIONS, PLEASE GET IN CONTACT.

ADAPT HIGH-BACK WITH BACK ONLY (DOUBLE SCREEN)

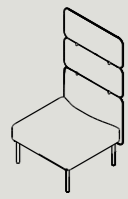

AHB1-D\*  
W 725 D 730 H 1350 S 440  
W 28.5" D 28.7" H 53.1" S17.3"



AHB2-D\*  
W 1360 D 730 H 1350 S 440  
W 53.5" D 28.7" H 53.1" S17.3"

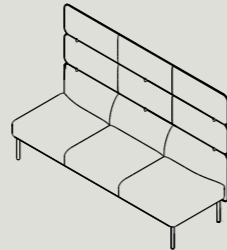

AHB3-D\*  
W 2040 D 730 H 1350 S 440  
W 80.3" D 28.7" H 53.1" S17.3"

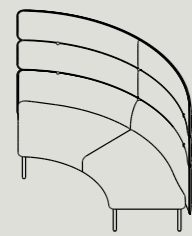

AHB90-D  
W 1530 D 1530 H 1350 S 440  
IN Ø1600 / OUT Ø3,040  
W 60.2" D 60.2" H 53.1" S17.3"  
IN Ø63.0" / OUT Ø119.7"

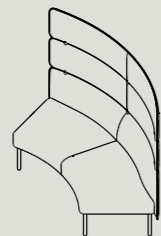

AHB60-D  
W 1660 D 1315 H 1350 S 440  
IN Ø2400 / OUT Ø3,860  
W 65.4" D 51.8" H 53.1" S17.3"  
IN Ø94.5" / OUT Ø152.0"

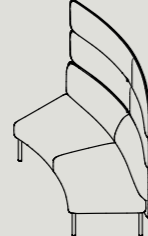

AHB45-D  
W 1660 D 1165 H 1350 S 440  
IN Ø3300 / OUT Ø4760  
W 65.4" D 45.9" H 53.1" S17.3"  
IN Ø129.9" / OUT Ø187.4"

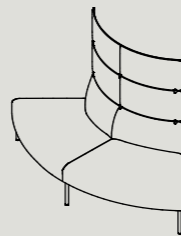

AHB90-R-D  
W 1480 D 1480 H 1350 S 440  
IN Ø1500 / OUT Ø2,960  
W 58.3" D 58.3" H 53.1" S17.3"  
IN Ø59.1" / OUT Ø116.5"

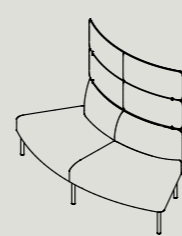

AHB60-R-D  
W 1610 D 1315 H 1350 S 440  
IN Ø2300 / OUT Ø3,760  
W 63.4" D 51.8" H 53.1" S17.3"  
IN Ø90.6" / OUT Ø148.0"

ADAPT HIGH-BACK WITH SINGLE ARM / CORNER (DOUBLE SCREEN)

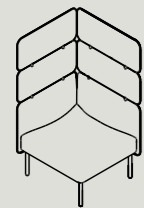

AHC1-D\*  
W 730 D 730 H 1350 S 440  
W 28.7" D 28.7" H 53.1" S17.3"

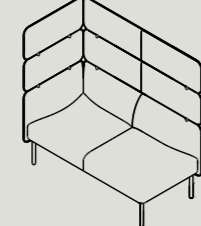

AHA2-D-R/L\*\*  
W 1410 D 730 H 1350 S 440  
W 55.5" D 28.7" H 53.1" S17.3"

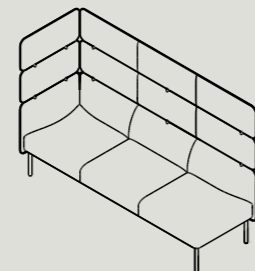

AHA3-D-R/L\*\*  
W 2090 D 730 H 1350 S 440  
W 82.3" D 28.7" H 53.1" S17.3"

ADAPT HIGH-BACK LOUNGE (DOUBLE SCREEN)

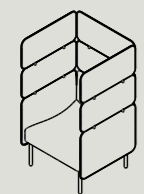

AHL1-D  
W 825 D 730 H 1350 S 440  
W 32.5" D 28.7" H 53.1" S17.3"

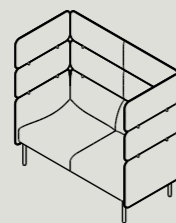

AHL2-D  
W 1460 D 730 H 1350 S 440  
W 57.5" D 28.7" H 53.1" S17.3"

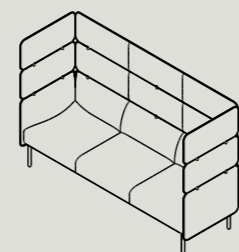

AHL3-D  
W 2140 D 730 H 1350 S 440  
W 84.25" D 28.7" H 53.1" S17.3"

ADAPT REAR DESK

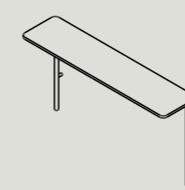

AD2-720  
W 1360 D 325 H 720  
W 53.5" D 12.8" H 28.3"

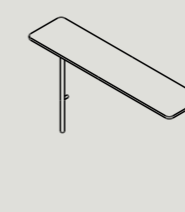

AD2-900  
W 1360 D 325 H 900  
W 53.5" D 12.8" H 35.4"

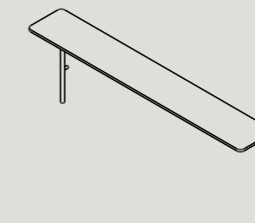

AD3-720  
W 2040 D 325 H 720  
W 80.3" D 12.8" H 28.3"

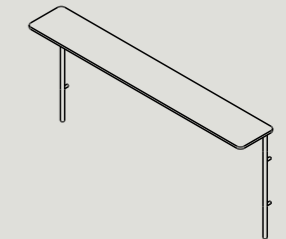

AD3-900  
W 2040 D 325 H 900  
W 80.3" D 12.8" H 35.4"



AD90-720  
W 2550 D 750 H 720  
OUT Ø3690



AD90-900  
W 2550 D 750 H 900  
OUT Ø3690

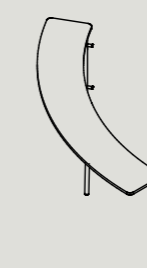

AD60-720  
W 2200 D 570 H 720  
OUT Ø4510

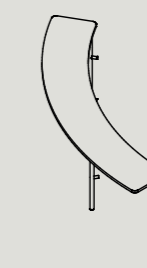

AD60-900  
W 2200 D 570 H 900  
OUT Ø4510

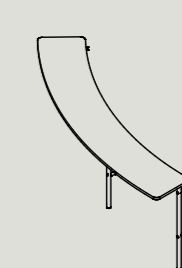

AD45-720  
W 2040 D 495 H 720  
OUT Ø5410

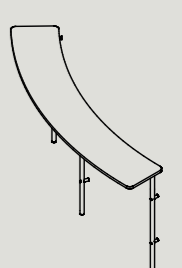

AD45-900  
W 2040 D 495 H 900  
OUT Ø5410

ADAPT LOUNGE DIVIDER SCREEN



DIVIDER LOW - SINGLE SCREEN  
ADL-SINGLE\*  
W 700 D 240 H 520  
W 27.6" D 9.5" H 20.5"



DIVIDER MID - SINGLE SCREEN  
ADM-SINGLE\*  
W 700 D 240 H 845  
W 27.6" D 9.5" H 33.3"



DIVIDER HIGH - SINGLE SCREEN  
ADH-SINGLE\*  
W 700 D 240 H 1170  
W 27.6" D 9.5" H 46.1"

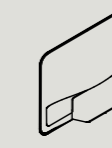

DIVIDER LOW - STANDARD SCREEN  
ADL-STANDARD\*  
W 700 D 240 H 520  
W 27.6" D 9.5" H 20.5"



DIVIDER MID - STANDARD SCREEN  
ADM-STANDARD\*  
W 700 D 240 H 845  
W 27.6" D 9.5" H 33.3"

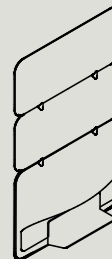

DIVIDER HIGH - STANDARD SCREEN  
ADH-STANDARD\*  
W 700 D 240 H 1170  
W 27.6" D 9.5" H 46.1"

OPTIONAL COMPONENTS



JOINING LEG  
AJL  
W 278 D 115 H 255  
W 10.9" D 4.5" H 10.0"



STABILITY LEG  
ASTL  
W 115 D 115 H 255



SUPPORT LEG  
ASUL  
W 90 D 64 H 255



FIXED LEG  
AFL  
W 115 D 115 H 255

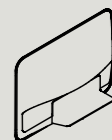

ARM/SINGLE BACKREST  
ABA  
W 140 D 680 H 500  
W 5.5 D 26.8 H 19.7"

\*R OR L REFERS TO RIGHT OR LEFT ARM LOCATION. ARM LOCATION IS DEFINED WHILE SITTING ON LOUNGE.  
#HIGH-BACK MODULES SHOULD BE SUPPORTED FROM BOTH ENDS, ACHIEVED THROUGH JOINING TO OTHER MODULES IN AN 'L' OR LINEAR CONFIGURATION.  
ALTERNATIVELY, ANGLED REAR LEGS WILL NEED TO BE USED  
DIMENSIONS SHOWN ARE INDICATIVE. FOR PROJECTS REQUIRING SPECIFIC DIMENSIONS, PLEASE GET IN CONTACT.

2 SEATER LOW-BACK ADAPT HUB

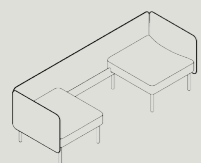

ALBT2-2185-NA  
W 2185 D 775 H 700 S 440

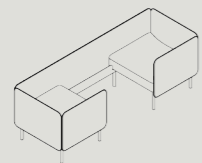

ALBT2-2185-ARM  
W 2185 D 825 H 700 S 440

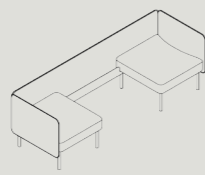

ALBT2-2335-NA  
W 2335 D 775 H 700 S 440

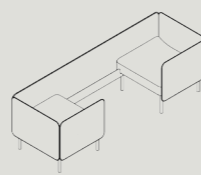

ALBT2-2335-ARM  
W 2335 D 825 H 700 S 440

4 SEATER LOW-BACK ADAPT HUB

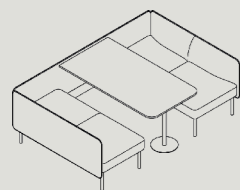

ALBT4-2185-NA  
W 2185 D 1410 H 700 S 440

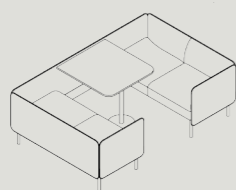

ALBT4-2185-ARM  
W 2185 D 1460 H 700 S 440

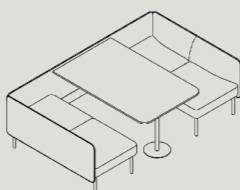

ALBT4-2335-NA  
W 2335 D 1410 H 700 S 440

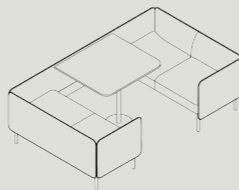

ALBT4-2335-ARM  
W 2335 D 1460 H 700 S 440

6 SEATER LOW-BACK ADAPT HUB

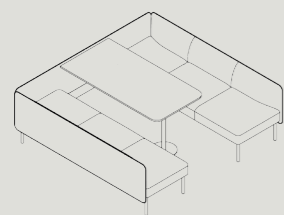

ALBT6-2185-NA  
W 2185 D 2090 H 1025 S 440

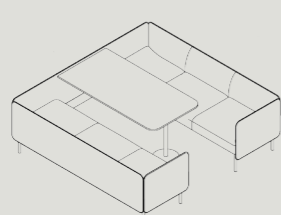

ALBT6-2185-ARM  
W 2185 D 2140 H 700 S 440

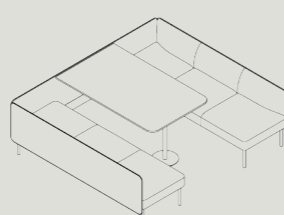

ALBT6-2335-NA  
W 2335 D 2090 H 700 S 440

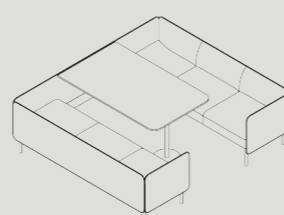

ALBT6-2335-ARM  
W 2335 D 2140 H 700 S 440

2 SEATER MID-BACK ADAPT HUB

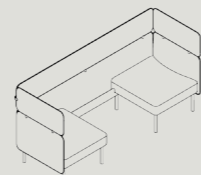

AMBT2-2185-NA  
W 2185 D 775 H 1025 S 440

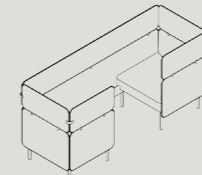

AMBT2-2185-ARM  
W 2185 D 825 H 1025 S 440

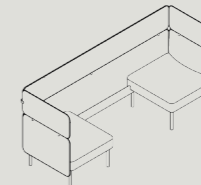

AMBT2-2335-NA  
W 2335 D 775 H 1025 S 440

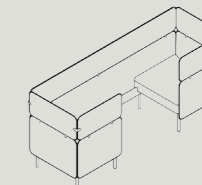

AMBT2-2335-ARM  
W 2335 D 825 H 1025 S 440

4 SEATER MID-BACK ADAPT HUB

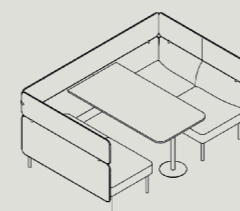

AMBT4-2185-NA  
W 2185 D 1410 H 1025 S 440

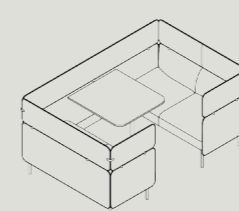

AMBT4-2185-ARM  
W 2185 D 1460 H 1025 S 440

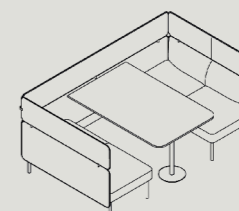

AMBT4-2335-NA  
W 2335 D 1410 H 1025 S 440

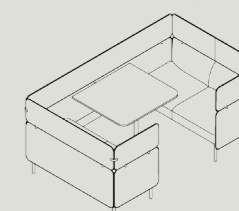

AMBT4-2335-ARM  
W 2335 D 1460 H 1025 S 440

6 SEATER MID-BACK ADAPT HUB

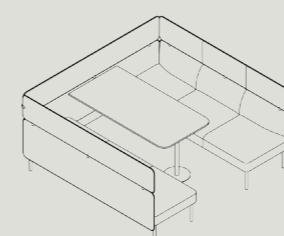

AMBT6-2185-NA  
W 2185 D 2090 H 1025 S 440

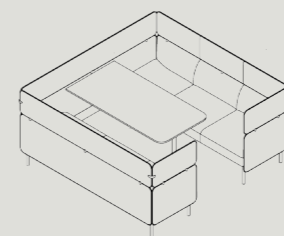

AMBT6-2185-ARM  
W 2185 D 2140 H 1025 S 440

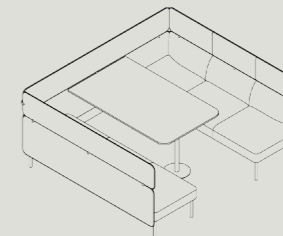

AMBT6-2335-NA  
W 2335 D 2090 H 1025 S 440

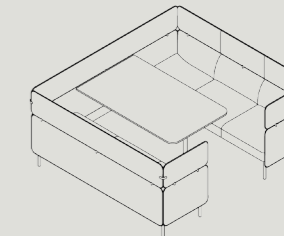

AMBT6-2335-ARM  
W 2335 D 2140 H 1025 S 440

2 SEATER HIGH-BACK (SINGLE SCREEN) ADAPT HUB

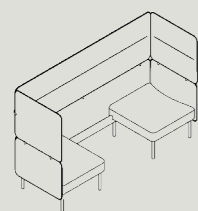

AHB2-S-2185-NA  
W 2185 D 775 H 1350 S 440

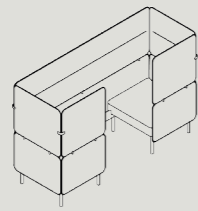

AHB2-S-2185-ARM  
W 2185 D 825 H 1350 S 440

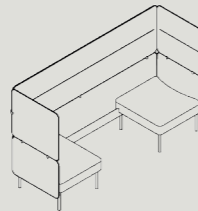

AHB2-S-2335-NA  
W 2335 D 775 H 1350 S 440

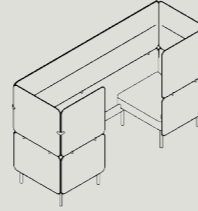

AHB2-S-2335-ARM  
W 2335 D 825 H 1350 S 440

2 SEATER HIGH-BACK (SINGLE SCREEN) ADAPT HUB

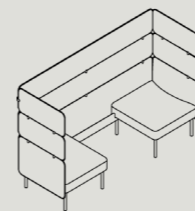

AHB2-D-2185-NA  
W 2185 D 775 H 1350 S 440

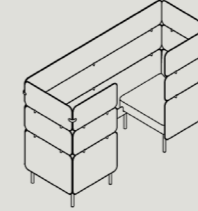

AHB2-D-2185-ARM  
W 2185 D 825 H 1350 S 440

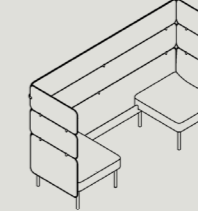

AHB2-D-2335-NA  
W 2335 D 775 H 1350 S 440

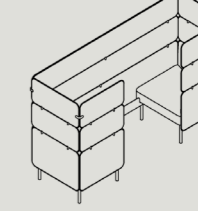

AHB2-D-2335-ARM  
W 2335 D 825 H 1350 S 440

4 SEATER HIGH-BACK (SINGLE SCREEN) ADAPT HUB

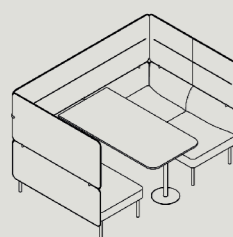

AHB4-S-2185-NA  
W 2185 D 1410 H 1350 S 440

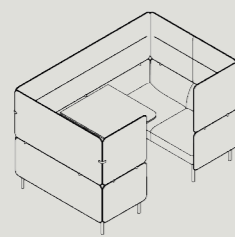

AHB4-S-2185-ARM  
W 2185 D 1460 H 1350 S 440

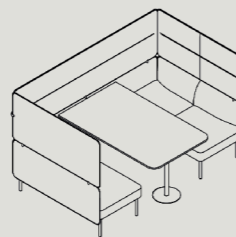

AHB4-S-2335-NA  
W 2335 D 1410 H 1350 S 440

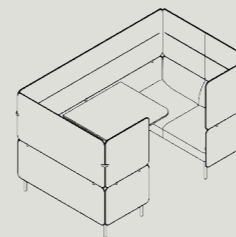

AHB4-S-2335-ARM  
W 2335 D 1460 H 1350 S 440

4 SEATER HIGH-BACK (SINGLE SCREEN) ADAPT HUB

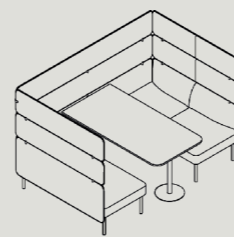

AHB4-D-2185-NA  
W 2185 D 1410 H 1350 S 440

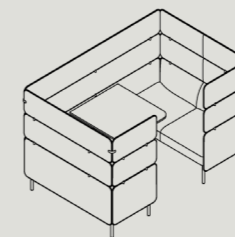

AHB4-D-2185-ARM  
W 2185 D 1460 H 1350 S 440

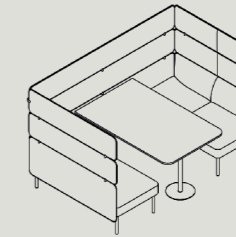

AHB4-D-2335-NA  
W 2335 D 1410 H 1350 S 440

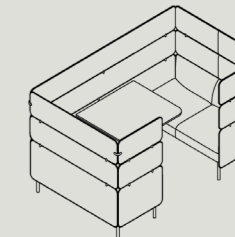

AHB4-D-2335-ARM  
W 2335 D 1460 H 1350 S 440

6 SEATER HIGH-BACK (SINGLE SCREEN) ADAPT HUB

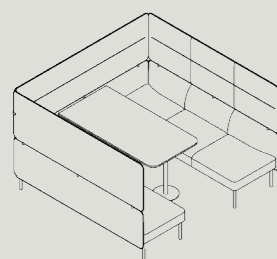

AHB6-S-2185-NA  
W 2185 D 2090 H 1350 S 440

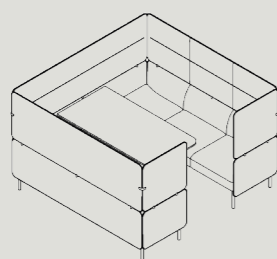

AHB6-S-2185-ARM  
W 2185 D 2140 H 1350 S 440

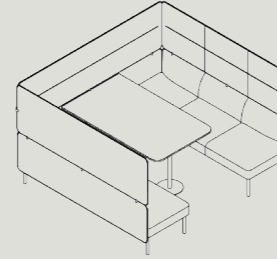

AHB6-S-2335-NA  
W 2335 D 2090 H 1350 S 440

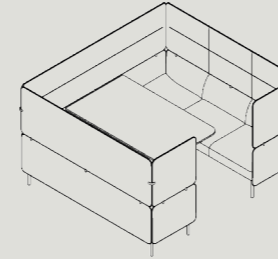

AHB6-S-2335-ARM  
W 2335 D 2140 H 1350 S 440

6 SEATER HIGH-BACK (SINGLE SCREEN) ADAPT HUB

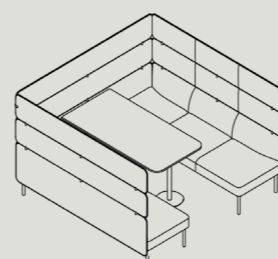

AHB6-D-2185-NA  
W 2185 D 2090 H 1350 S 440



AHB6-D-2185-ARM  
W 2185 D 2140 H 1350 S 440

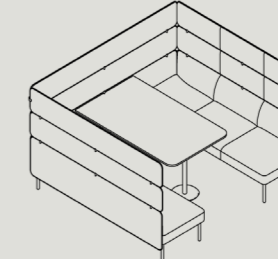

AHB6-D-2335-NA  
W 2335 D 2090 H 1350 S 440

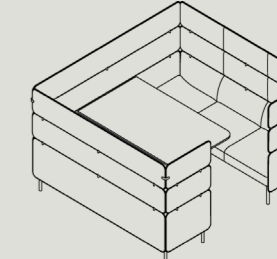

AHB6-D-2335-ARM  
W 2335 D 2140 H 1350 S 440

DIMENSIONS SHOWN ARE INDICATIVE. FOR PROJECTS REQUIRING SPECIFIC DIMENSIONS, PLEASE GET IN CONTACT.



## ADAPT WORK

WORKSTATIONS

A continuation of the Adapt Lounge and Adapt Hub, the Adapt Work features the same ethos and design details in a flexible desk-based workstation. Created to facilitate collaborative interactions and individual focus within adaptable settings, Adapt Work offers an array of possibilities for the ideal open or secluded workspace.

With its array of desk widths, height options and privacy levels, Adapt Work is a versatile solution for diverse environments such as offices, universities and schools, whether in compact confines or expansive open layouts. Arms and backs can be shared, optimising space utilisation as well as reducing cost and fabric usage and allowing for back-to-back and side-to-side configurations. The module nature of the system also enables perpendicular or enclosed configurations, affording various degrees of privacy to suit distinct requirements.

### AVAILABLE LEG FINISHES



### AVAILABLE UPHOLSTERY

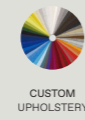

### TECHNICAL

ALL ADAPT WORK CONFIGURATIONS ARE AVAILABLE IN 3 DESK WIDTHS; 1330, 1520 (AS SHOWN) & 1710MM)

PRODUCT CODES SKU  
EG. AWH-D-OL4-B-XXXX = ADAPT WORK HIGH-BACK - DOUBLE SCREEN - OPEN LINEAR 4 DESK - BACK-TO-BACK - XXXX (DESK WIDTH)

### ADAPT WORK MID-BACK OPEN SINGLE / LINEAR

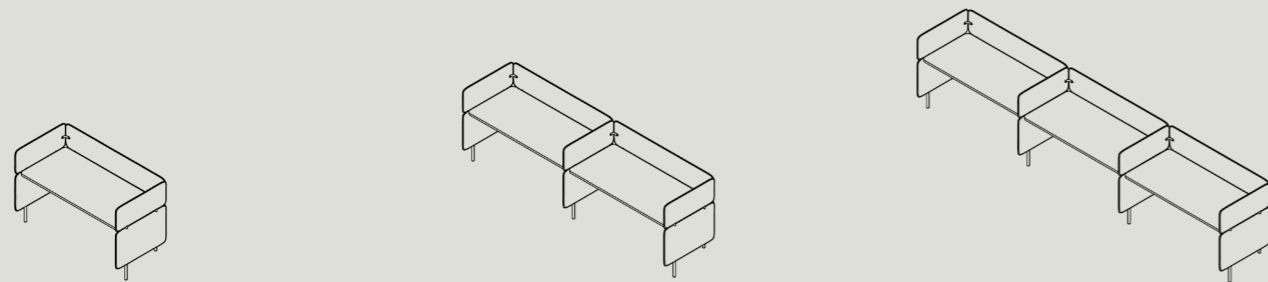

AWM-OL1-XXXX  
1330 - W 1460 / D 825 / H 1025  
1520 - W 1650 / D 825 / H 1025  
1710 - W 1840 / D 825 / H 1025

AWM-OL2-XXXX  
1330 - W 2855 / D 825 / H 1025  
1520 - W 3235 / D 825 / H 1025  
1710 - W 3615 / D 825 / H 1025

AWM-OL3-XXXX  
1330 - W 4350 / D 825 / H 1025  
1520 - W 4820 / D 825 / H 1025  
1710 - W 5390 / D 825 / H 1025

### ADAPT WORK MID-BACK OPEN DESK ALTERNATING

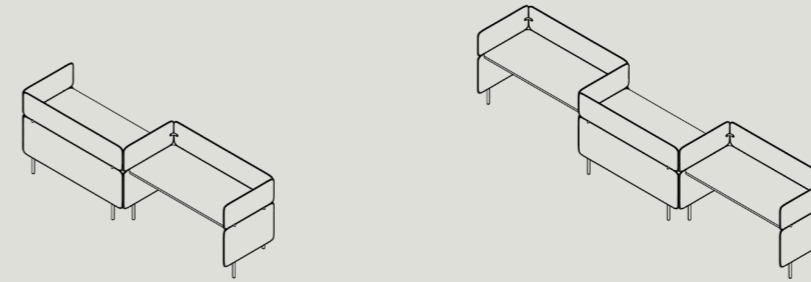

AWM-OL2-A-XXXX  
1330 - W 2855 / D 825 / H 1025  
1520 - W 3235 / D 825 / H 1025  
1710 - W 3615 / D 825 / H 1025

AWM-OL3-A-XXXX  
1330 - W 4350 / D 825 / H 1025  
1520 - W 4820 / D 825 / H 1025  
1710 - W 5390 / D 825 / H 1025

### ADAPT WORK MID-BACK OPEN BACK TO BACK

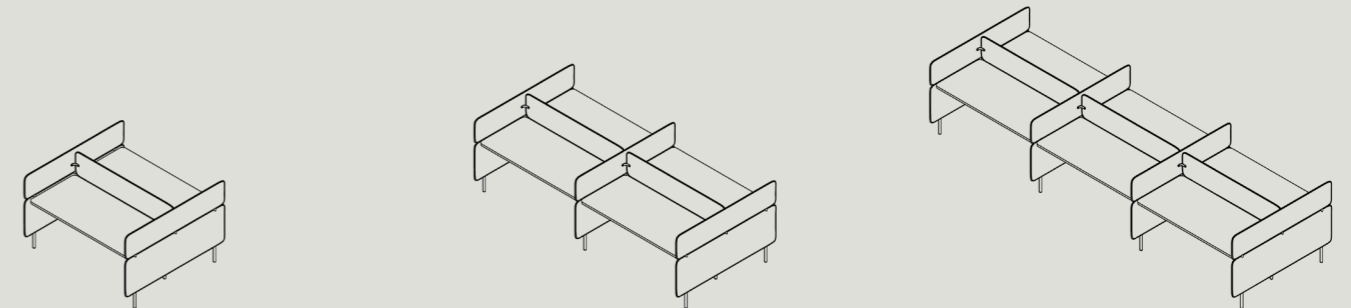

AWM-OL2-B-XXXX  
1330 - W 1460 / D 1650 / H 1025  
1520 - W 1650 / D 1650 / H 1025  
1710 - W 1840 / D 1650 / H 1025

AWM-OL4-B-XXXX  
1330 - W 2855 / D 1650 / H 1025  
1520 - W 3235 / D 1650 / H 1025  
1710 - W 3615 / D 1650 / H 1025

AWM-OL6-B-XXXX  
1330 - W 4250 / D 1650 / H 1025  
1520 - W 4820 / D 1650 / H 1025  
1710 - W 5390 / D 1650 / H 1025

### ADAPT WORK MID-BACK OPEN PERPENDICULAR

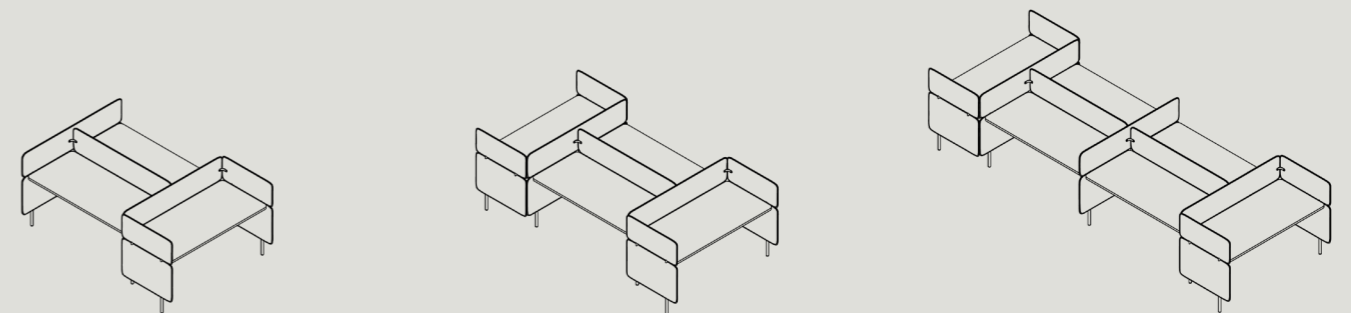

AWM-OP3-XXXX  
1330 - W 2220 / D 1650 / H 1025  
1520 - W 2410 / D 1650 / H 1025  
1710 - W 2600 / D 1650 / H 1025

AWM-OP4-XXXX  
1330 - W 2980 / D 1650 / H 1025  
1520 - W 3170 / D 1650 / H 1025  
1710 - W 3360 / D 1650 / H 1025

AWM-OP6-XXXX  
1330 - W 4375 / D 1650 / H 1025  
1520 - W 4755 / D 1650 / H 1025  
1710 - W 5135 / D 1650 / H 1025

ADAPT WORK MID-BACK SEMI PRIVATE SINGLE / LINEAR

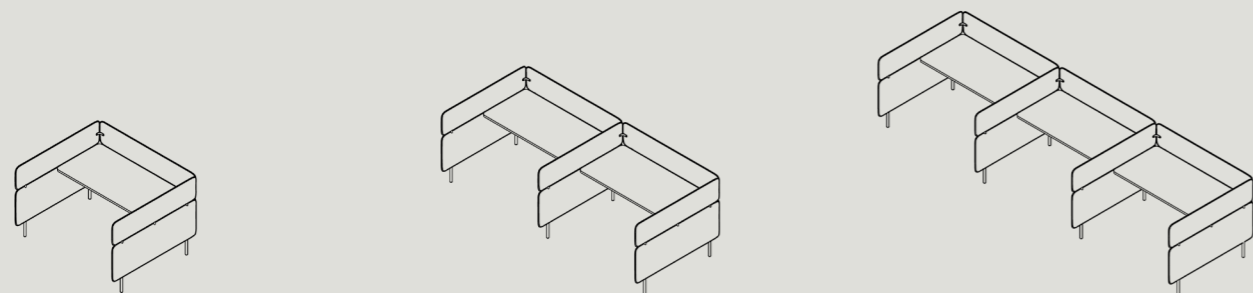

AWM-SPL1-XXXX  
1330 - W 1460 / D 1460 / H 1025  
1520 - W 1650 / D 1460 / H 1025  
1710 - W 1840 / D 1460 / H 1025

AWM-SPL2-XXXX  
1330 - W 2855 / D 1460 / H 1025  
1520 - W 3235 / D 1460 / H 1025  
1710 - W 3615 / D 1460 / H 1025

AWM-SPL3-XXXX  
1330 - W 4250 / D 1460 / H 1025  
1520 - W 4820 / D 1460 / H 1025  
1710 - W 5390 / D 1460 / H 1025

ADAPT WORK MID-BACK PRIVATE SINGLE / LINEAR

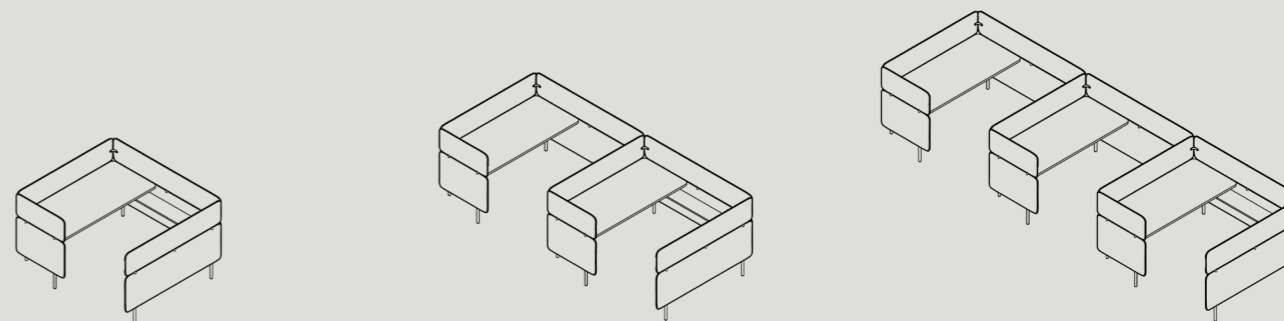

AWM-PL1-XXXX  
1330 - W 1840 / D 1460 / H 1025  
1520 - W 1840 / D 1650 / H 1025  
1710 - W 1840 / D 1840 / H 1025

AWM-PL2-XXXX  
1330 - W 3605 / D 1460 / H 1025  
1520 - W 3605 / D 1650 / H 1025  
1710 - W 3605 / D 1840 / H 1025

AWM-PL3-XXXX  
1330 - W 5370 / D 1460 / H 1025  
1520 - W 5370 / D 1650 / H 1025  
1710 - W 5370 / D 1840 / H 1025

ADAPT WORK MID-BACK SEMI PRIVATE ALTERNATING

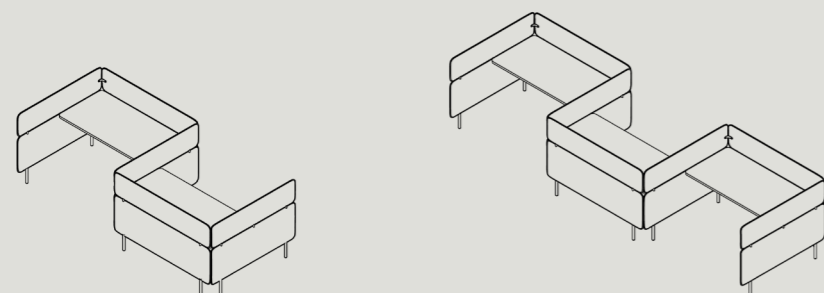

AWM-SPL2-A-XXXX  
1330 - W 2855 / D 1460 / H 1025  
1520 - W 3235 / D 1460 / H 1025  
1710 - W 3615 / D 1460 / H 1025

AWM-SPL3-A-XXXX  
1330 - W 4250 / D 1460 / H 1025  
1520 - W 4820 / D 1460 / H 1025  
1710 - W 5390 / D 1460 / H 1025

ADAPT WORK MID-BACK PRIVATE ALTERNATING

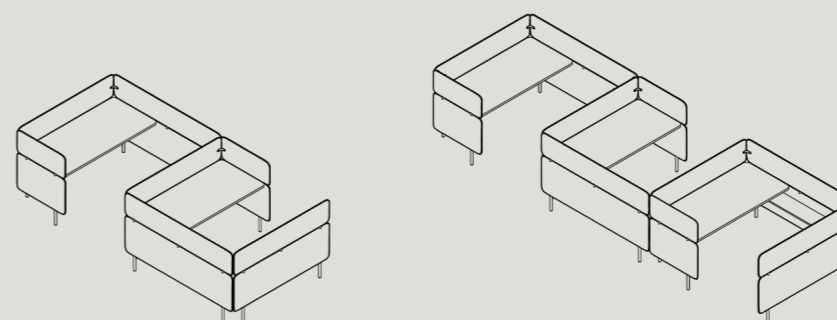

AWM-PL2-A-XXXX  
1330 - W 3605 / D 1460 / H 1025  
1520 - W 3605 / D 1650 / H 1025  
1710 - W 3605 / D 1840 / H 1025

AWM-PL3-A-1520\*  
1330 - W 5370 / D 1460 / H 1025  
1520 - W 5370 / D 1650 / H 1025  
1710 - W 5370 / D 1840 / H 1025

ADAPT WORK MID-BACK SEMI PRIVATE BACK TO BACK

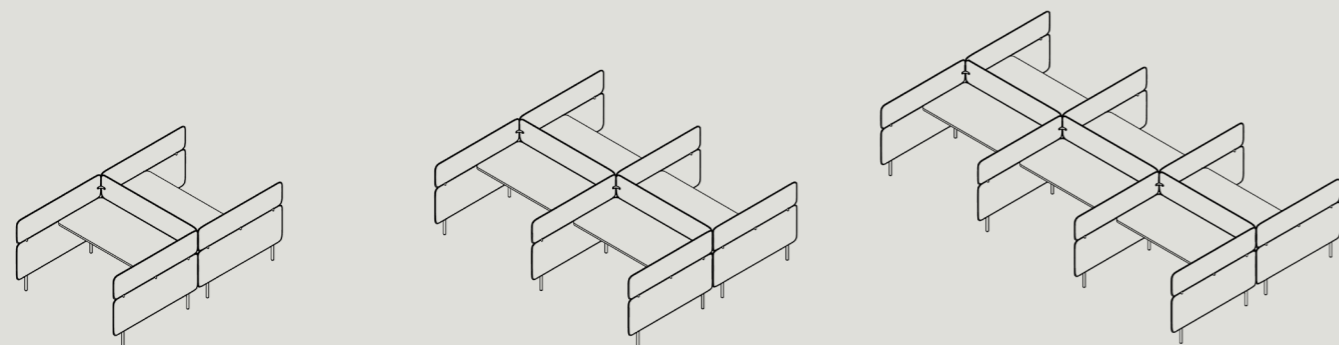

AWM-SPL2-B-XXXX  
1330 - W 1460 / D 2845 / H 1025  
1520 - W 1650 / D 2845 / H 1025  
1710 - W 1840 / D 2845 / H 1025

AWM-SPL4-B-XXXX  
1330 - W 2855 / D 2845 / H 1025  
1520 - W 3235 / D 2845 / H 1025  
1710 - W 3615 / D 2845 / H 1025

AWM-SPL6-B-XXXX  
1330 - W 4250 / D 2845 / H 1025  
1520 - W 4820 / D 2845 / H 1025  
1710 - W 5390 / D 2845 / H 1025

ADAPT WORK MID-BACK PRIVATE BACK TO BACK

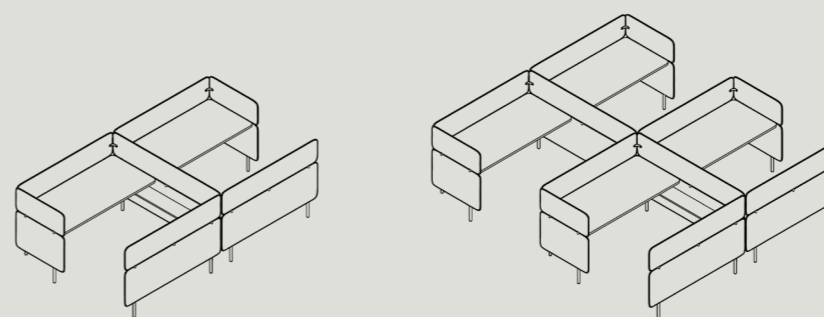

AWM-PL2-B-XXXX  
1330 - W 1840 / D 2855 / H 1025  
1520 - W 1840 / D 3235 / H 1025  
1710 - W 1840 / D 3615 / H 1025

AWM-PL4-B-XXXX  
1330 - W 3605 / D 2855 / H 1025  
1520 - W 3605 / D 3235 / H 1025  
1710 - W 3605 / D 3615 / H 1025

ADAPT WORK HIGH-BACK OPEN SINGLE / LINEAR (SINGLE SCREEN)

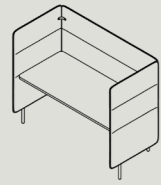

AWH-S-OL1-XXXX  
1330 - W 1460 / D 825 / H 1350  
1520 - W 1650 / D 825 / H 1350  
1710 - W 1840 / D 825 / H 1350

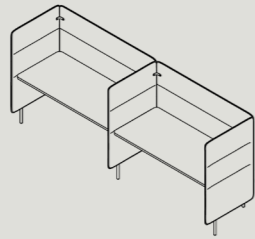

AWH-S-OL2-XXXX  
1330 - W 2855 / D 825 / H 1350  
1520 - W 3235 / D 825 / H 1350  
1710 - W 3615 / D 825 / H 1350

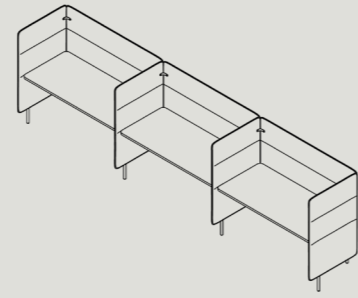

AWH-S-OL3-XXXX  
1330 - W 4250 / D 825 / H 1350  
1520 - W 4820 / D 825 / H 1350  
1710 - W 5390 / D 825 / H 1350

ADAPT WORK HIGH-BACK OPEN PERPENDICULAR (SINGLE SCREEN)

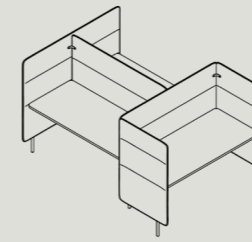

AWM-S-OP3-XXXX  
1330 - W 2220 / D 1650 / H 1350  
1520 - W 2410 / D 1650 / H 1350  
1710 - W 2600 / D 1650 / H 1350

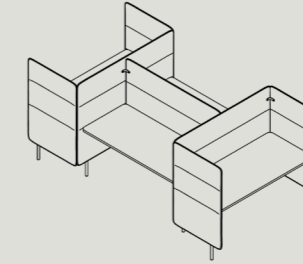

AWM-S-OP4-XXXX  
1330 - W 2980 / D 1650 / H 1350  
1520 - W 3170 / D 1650 / H 1350  
1710 - W 3360 / D 1650 / H 1350

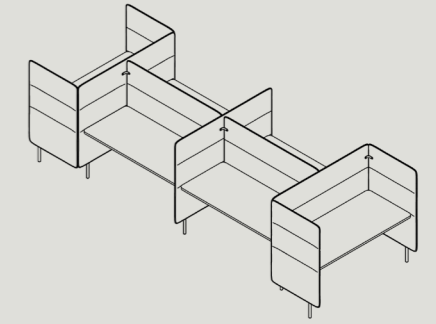

AWM-S-OP6-XXXX  
1330 - W 4375 / D 1650 / H 1350  
1520 - W 4755 / D 1650 / H 1350  
1710 - W 5135 / D 1650 / H 1350

ADAPT WORK HIGH-BACK OPEN ALTERNATING (SINGLE SCREEN)

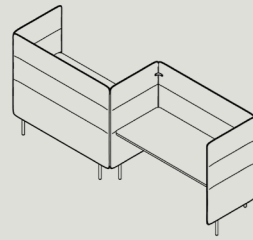

AWH-S-OL2-A-XXXX  
1330 - W 2855 / D 825 / H 1350  
1520 - W 3235 / D 825 / H 1350  
1710 - W 3615 / D 825 / H 1350

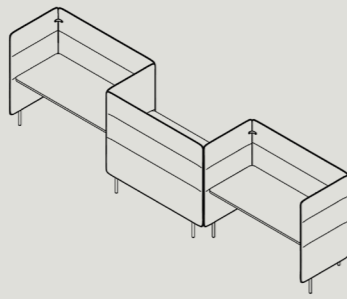

AWH-S-OL3-A-XXXX  
1330 - W 4250 / D 825 / H 1350  
1520 - W 4820 / D 825 / H 1350  
1710 - W 5390 / D 825 / H 1350

ADAPT WORK HIGH-BACK SEMI PRIVATE SINGLE / LINEAR (SINGLE SCREEN)

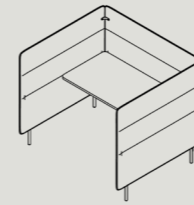

AWH-S-SPL1-XXXX  
1330 - W 1460 / D 1460 / H 1350  
1520 - W 1650 / D 1460 / H 1350  
1710 - W 1840 / D 1460 / H 1350

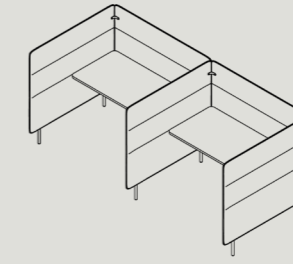

AWH-S-SPL2-XXXX  
1330 - W 2855 / D 1460 / H 1350  
1520 - W 3235 / D 1460 / H 1350  
1710 - W 3615 / D 1460 / H 1350

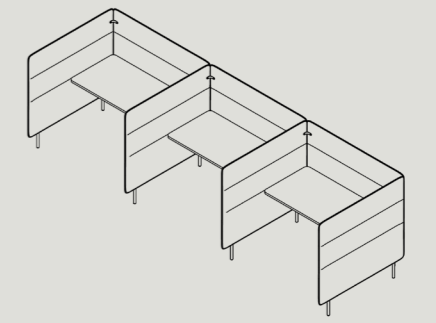

AWH-S-SPL3-XXXX  
1330 - W 4250 / D 1460 / H 1350  
1520 - W 4820 / D 1460 / H 1350  
1710 - W 5390 / D 1460 / H 1350

ADAPT WORK HIGH-BACK OPEN BACK TO BACK (SINGLE SCREEN)

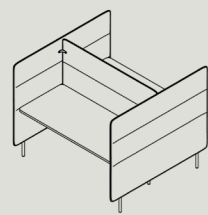

AWH-S-OL2-B-XXXX  
1330 - W 1460 / D 1650 / H 1350  
1520 - W 1650 / D 1650 / H 1350  
1710 - W 1840 / D 1650 / H 1350

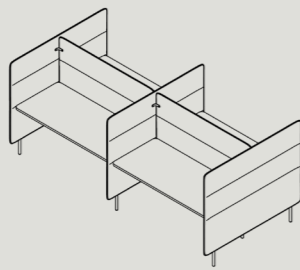

AWH-S-OL4-B-XXXX  
1330 - W 2855 / D 1650 / H 1350  
1520 - W 3235 / D 1650 / H 1350  
1710 - W 3615 / D 1650 / H 1350

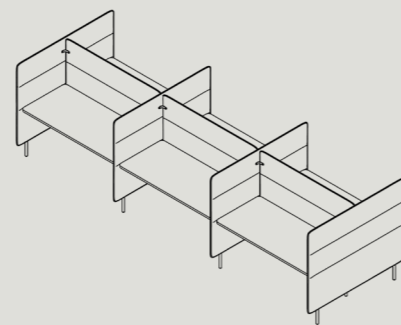

AWH-S-OL6-B-XXXX  
1330 - W 4250 / D 1650 / H 1350  
1520 - W 4820 / D 1650 / H 1350  
1710 - W 5390 / D 1650 / H 1350

ADAPT WORK HIGH-BACK SEMI PRIVATE ALTERNATING (SINGLE SCREEN)

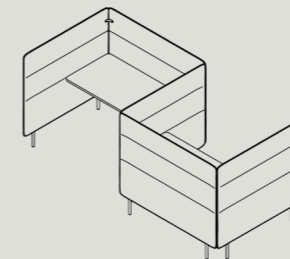

AWH-S-SPL2-A-XXXX  
1330 - W 2855 / D 1460 / H 1350  
1520 - W 3235 / D 1460 / H 1350  
1710 - W 3615 / D 1460 / H 1350

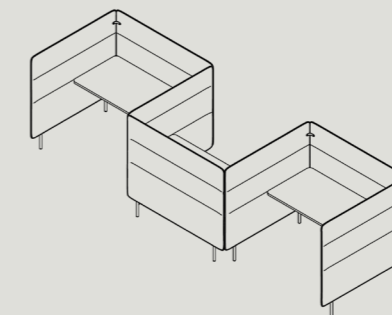

AWH-S-SPL3-A-XXXX  
1330 - W 4250 / D 1460 / H 1350  
1520 - W 4820 / D 1460 / H 1350  
1710 - W 5390 / D 1460 / H 1350



ADAPT WORK HIGH-BACK SEMI PRIVATE BACK TO BACK (SINGLE SCREEN)

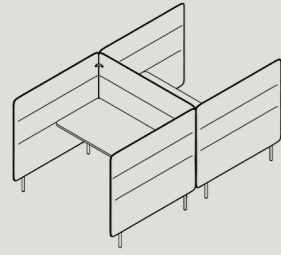

AWH-S-SPL2-B-XXXX  
1330 - W 1460 / D 2845 / H 1350  
1520 - W 1650 / D 2845 / H 1350  
1710 - W 1840 / D 2845 / H 1350

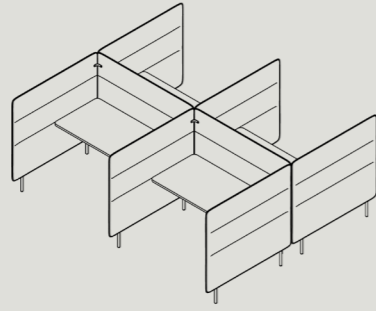

AWH-S-SPL4-B-XXXX  
1330 - W 2855 / D 2845 / H 1350  
1520 - W 3235 / D 2845 / H 1350  
1710 - W 3615 / D 2845 / H 1350

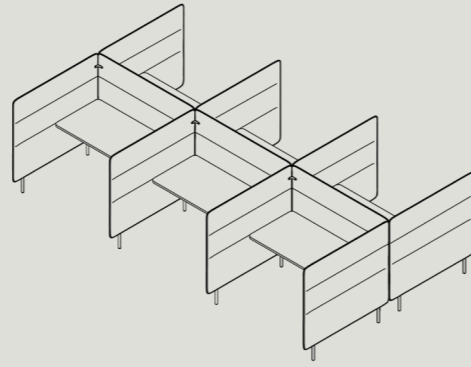

AWH-S-SPL6-B-XXXX  
1330 - W 4250 / D 2845 / H 1350  
1520 - W 4820 / D 2845 / H 1350  
1710 - W 5390 / D 2845 / H 1350

ADAPT WORK HIGH-BACK PRIVATE BACK TO BACK (SINGLE SCREEN)

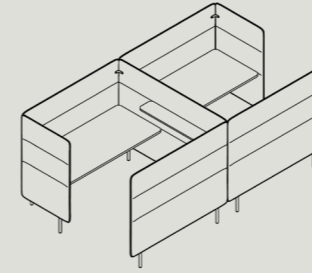

AWH-S-PL2-B-XXXX  
W 1840 / D 2855 / H 1350  
W 1840 / D 3235 / H 1350  
W 1840 / D 3615 / H 1350

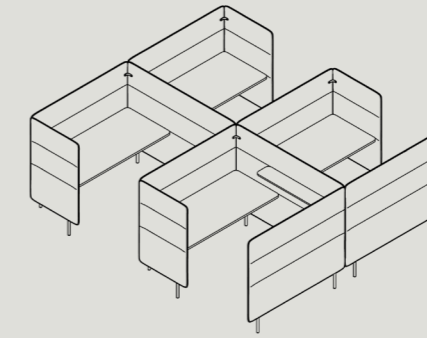

AWH-S-PL4-B-XXXX  
W 3605 / D 2855 / H 1350  
W 3605 / D 3235 / H 1350  
W 3605 / D 3615 / H 1350

ADAPT WORK HIGH-BACK PRIVATE SINGLE / LINEAR (SINGLE SCREEN)

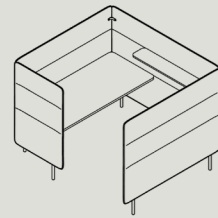

AWH-S-PL1-XXXX  
1330 - W 1840 / D 1460 / H 1350  
1520 - W 1840 / D 1650 / H 1350  
1710 - W 1840 / D 1840 / H 1350

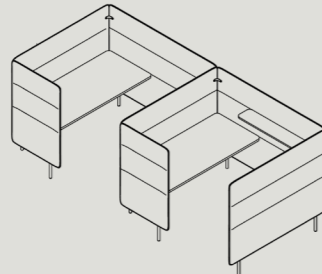

AWH-S-PL2-XXXX  
1330 - W 3605 / D 1460 / H 1350  
1520 - W 3605 / D 1650 / H 1350  
1710 - W 3605 / D 1840 / H 1350

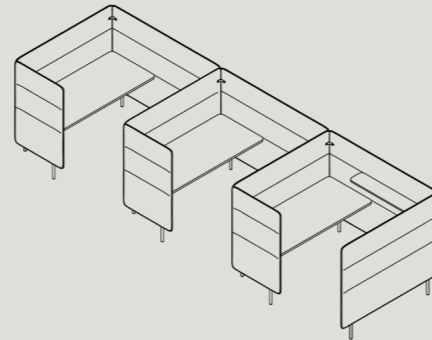

AWH-S-PL3-XXXX  
1330 - W 5370 / D 1460 / H 1350  
1520 - W 5370 / D 1650 / H 1350  
1710 - W 5370 / D 1840 / H 1350

ADAPT WORK HIGH-BACK OPEN SINGLE / LINEAR (DOUBLE SCREEN)

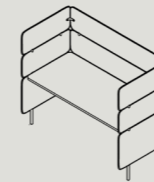

AWH-D-OL1-XXXX  
1330 - W 1460 / D 825 / H 1350  
1520 - W 1650 / D 825 / H 1350  
1710 - W 1840 / D 825 / H 1350

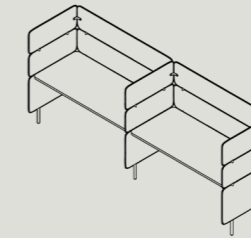

AWH-D-OL2-XXXX  
1330 - W 2855 / D 825 / H 1350  
1520 - W 3235 / D 825 / H 1350  
1710 - W 3615 / D 825 / H 1350

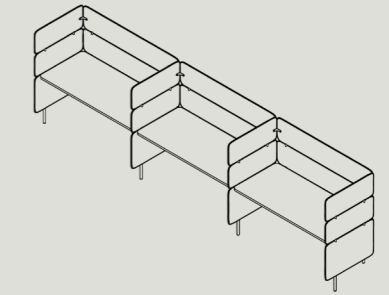

AWH-D-OL3-XXXX  
1330 - W 4250 / D 825 / H 1350  
1520 - W 4820 / D 825 / H 1350  
1710 - W 5390 / D 825 / H 1350

ADAPT WORK HIGH-BACK PRIVATE ALTERNATING (SINGLE SCREEN)

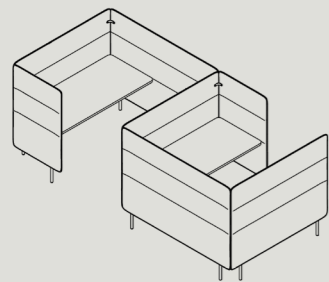

AWH-S-PL2-A-XXXX  
1330 - W 3605 / D 1460 / H 1350  
1520 - W 3605 / D 1650 / H 1350  
1710 - W 3605 / D 1840 / H 1350

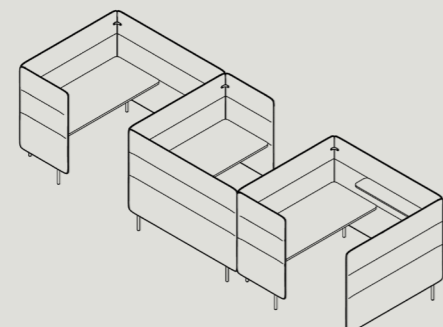

AWH-S-PL3-A-XXXX  
1330 - W 5370 / D 1460 / H 1350  
1520 - W 5370 / D 1650 / H 1350  
1710 - W 5370 / D 1840 / H 1350

ADAPT WORK HIGH-BACK OPEN ALTERNATING (DOUBLE SCREEN)

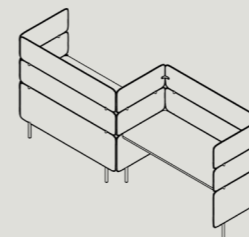

AWH-D-OL2-A-XXXX  
1330 - W 2855 / D 825 / H 1350  
1520 - W 3235 / D 825 / H 1350  
1710 - W 3615 / D 825 / H 1350

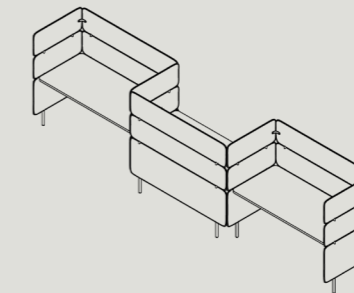

AWH-D-OL3-A-XXXX  
1330 - W 4250 / D 825 / H 1350  
1520 - W 4820 / D 825 / H 1350  
1710 - W 5390 / D 825 / H 1350

ADAPT WORK HIGH-BACK OPEN BACK TO BACK (DOUBLE SCREEN)

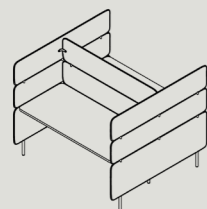

AWH-D-OL2-B-XXXX  
1330 - W 1460 / D 1650 / H 1350  
1520 - W 1650 / D 1650 / H 1350  
1710 - W 1840 / D 1650 / H 1350

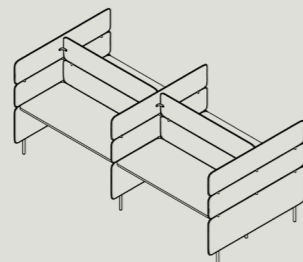

AWH-D-OL4-B-XXXX  
1330 - W 2855 / D 1650 / H 1350  
1520 - W 3235 / D 1650 / H 1350  
1710 - W 3615 / D 1650 / H 1350

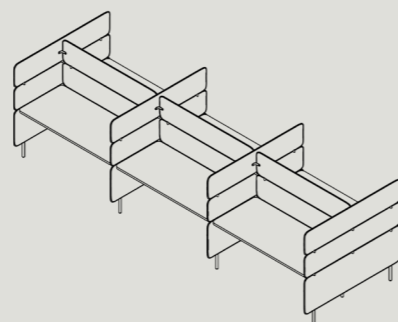

AWH-D-OL6-B-XXXX  
1330 - W 4250 / D 1650 / H 1350  
1520 - W 4820 / D 1650 / H 1350  
1710 - W 5390 / D 1650 / H 1350

ADAPT WORK HIGH-BACK SEMI PRIVATE ALTERNATING (DOUBLE SCREEN)

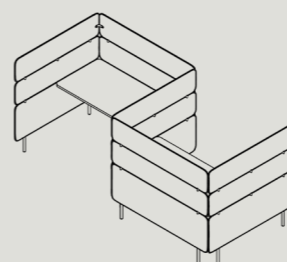

AWH-D-SPL2-A-XXXX  
1330 - W 2855 / D 1460 / H 1350  
1520 - W 3235 / D 1460 / H 1350  
1710 - W 3615 / D 1460 / H 1350

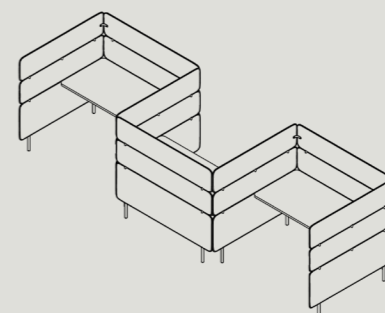

AWH-D-SPL3-A-XXXX  
1330 - W 4250 / D 1460 / H 1350  
1520 - W 4820 / D 1460 / H 1350  
1710 - W 5390 / D 1460 / H 1350

ADAPT WORK HIGH-BACK OPEN PERPENDICULAR (DOUBLE SCREEN)

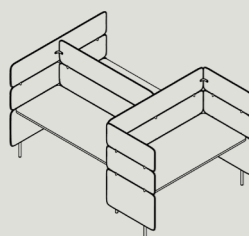

AWM-D-OP3-XXXX  
1330 - W 2220 / D 1650 / H 1350  
1520 - W 2410 / D 1650 / H 1350  
1710 - W 2600 / D 1650 / H 1350

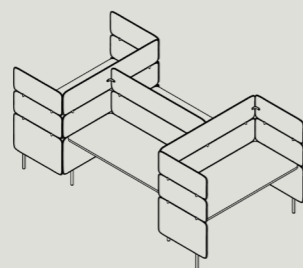

AWM-D-OP4-XXXX  
1330 - W 2980 / D 1650 / H 1350  
1520 - W 3170 / D 1650 / H 1350  
1710 - W 3360 / D 1650 / H 1350

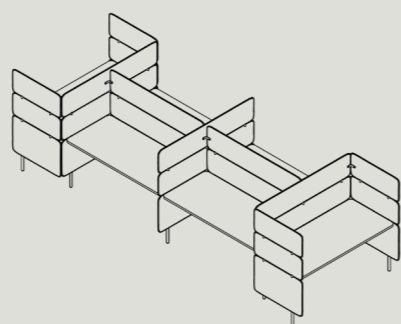

AWM-D-OP6-XXXX  
1330 - W 4375 / D 1650 / H 1350  
1520 - W 4755 / D 1650 / H 1350  
1710 - W 5135 / D 1650 / H 1350

ADAPT WORK HIGH-BACK SEMI PRIVATE BACK TO BACK (DOUBLE SCREEN)

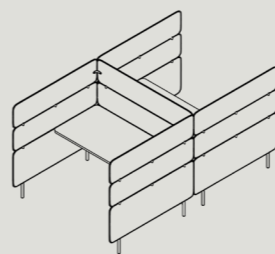

AWH-D-SPL2-B-XXXX  
1330 - W 1460 / D 2845 / H 1350  
1520 - W 1650 / D 2845 / H 1350  
1710 - W 1840 / D 2845 / H 1350

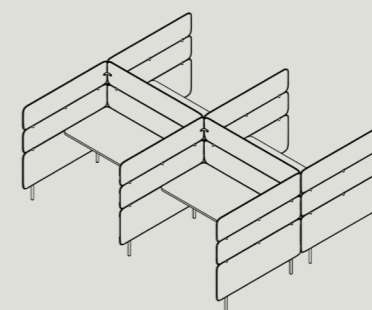

AWH-D-SPL4-B-XXXX  
1330 - W 2855 / D 2845 / H 1350  
1520 - W 3235 / D 2845 / H 1350  
1710 - W 3615 / D 2845 / H 1350

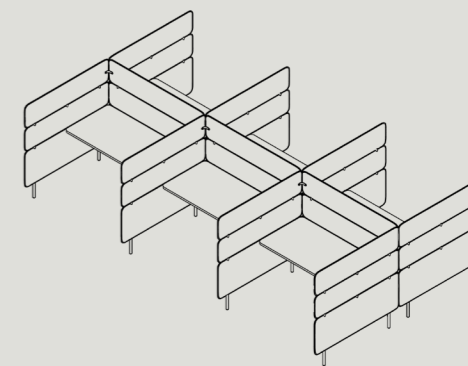

AWH-D-SPL6-B-XXXX  
1330 - W 4250 / D 2845 / H 1350  
1520 - W 4820 / D 2845 / H 1350  
1710 - W 5390 / D 2845 / H 1350

ADAPT WORK HIGH-BACK SEMI PRIVATE SINGLE / LINEAR (DOUBLE SCREEN)

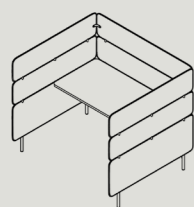

AWH-D-SPL1-XXXX  
1330 - W 1460 / D 1460 / H 1350  
1520 - W 1650 / D 1460 / H 1350  
1710 - W 1840 / D 1460 / H 1350

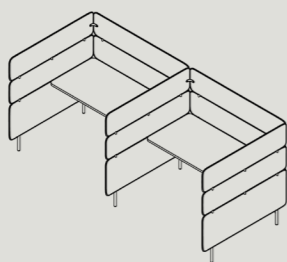

AWH-D-SPL2-XXXX  
1330 - W 2855 / D 1460 / H 1350  
1520 - W 3235 / D 1460 / H 1350  
1710 - W 3615 / D 1460 / H 1350

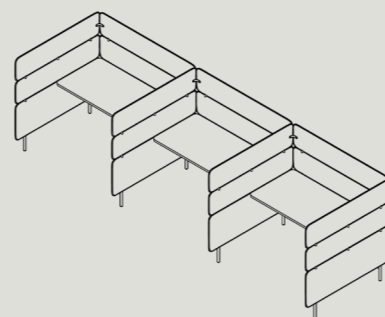

AWH-D-SPL3-XXXX  
1330 - W 4250 / D 1460 / H 1350  
1520 - W 4820 / D 1460 / H 1350  
1710 - W 5390 / D 1460 / H 1350

ADAPT WORK HIGH-BACK PRIVATE SINGLE / LINEAR (DOUBLE SCREEN)

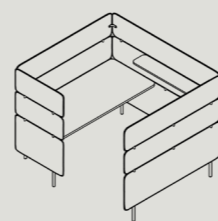

AWH-D-PL1-XXXX  
1330 - W 1840 / D 1460 / H 1350  
1520 - W 1840 / D 1650 / H 1350  
1710 - W 1840 / D 1840 / H 1350

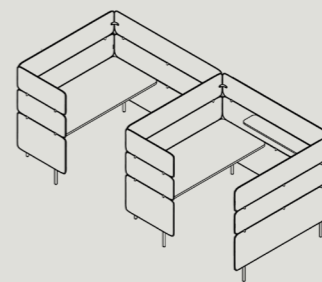

AWH-D-PL2-XXXX  
1330 - W 3605 / D 1460 / H 1350  
1520 - W 3605 / D 1650 / H 1350  
1710 - W 3605 / D 1840 / H 1350

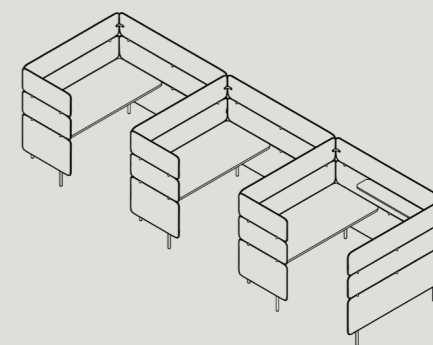

AWH-D-PL3-XXXX  
1330 - W 5370 / D 1460 / H 1350  
1520 - W 5370 / D 1650 / H 1350  
1710 - W 5370 / D 1840 / H 1350

ADAPT WORK HIGH-BACK PRIVATE ALTERNATING (DOUBLE SCREEN)

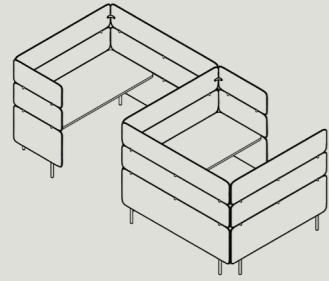

AWH-D-PL2-A-XXXX  
 1330 - W 3605 / D 1460 / H 1350  
 1520 - W 3605 / D 1650 / H 1350  
 1710 - W 3605 / D 1840 / H 1350

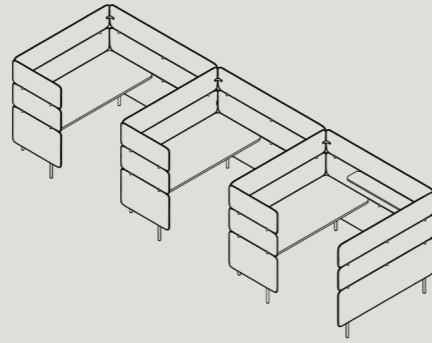

AWH-D-PL3-A-XXXX  
 1330 - W 5370 / D 1460 / H 1350  
 1520 - W 5370 / D 1650 / H 1350  
 1710 - W 5370 / D 1840 / H 1350

ADAPT WORK HIGH-BACK PRIVATE BACK TO BACK (DOUBLE SCREEN)

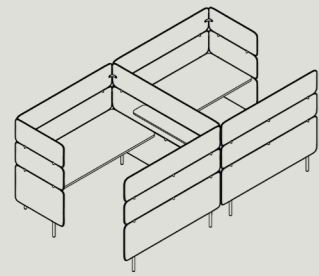

AWH-D-PL2-B-XXXX  
 1330 - W 1840 / D 2855 / H 1350  
 1520 - W 1840 / D 3235 / H 1350  
 1710 - W 1840 / D 3615 / H 1350

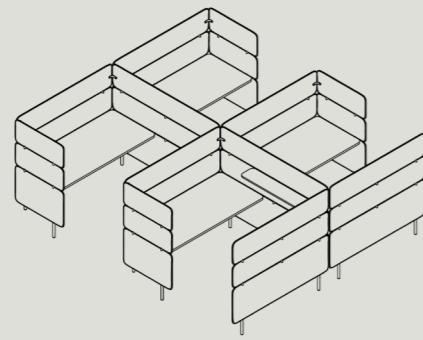

AWH-D-PL4-B-XXXX  
 1330 - W 3605 / D 2855 / H 1350  
 1520 - W 3605 / D 3235 / H 1350  
 1710 - W 3605 / D 3615 / H 1350



**ADAPT**  
TABLE

Flexible, inviting and productive, the Adapt collection of lounges and accessories are designed to evolve with the dynamic needs of today's workspace. Designed to interconnect between Adapt Lounges and Ottomans or to be used as stand-alone tables, the Adapt Side Table is a functional table to complement the Adapt range. The table is available with the option to connect, suspend or standalone to allow for maximum flexibility in creating your space.

Featuring a black or white powder coated mild steel edge, the table top surface is available in black and white laminate or black mirror.

Adapt Tables are made in Melbourne and fully GECA certified - FFG-200026. Under GECA, products are certified against environmental performance criteria across its life cycle to ensure they deliver better environmental outcomes.

AVAILABLE TOP FINISHES

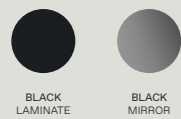

BLACK LAMINATE

BLACK MIRROR

AVAILABLE FRAME AND LEG FINISHES



BLACK POWDER COAT

DIMENSIONS

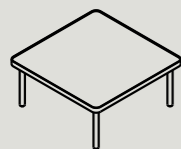

AT-310-A  
W 675 D 675 H 310  
W 26.6" D 26.6" H 12.2"

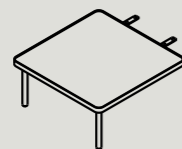

AT-310-B  
W 675 D 675 H 310  
W 26.6" D 26.6" H 12.2"

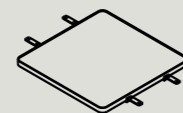

AT-310-C  
W 675 D 675 H 310  
W 26.6" D 26.6" H 12.2"  
(WHEN MOUNTED TO LOUNGES)

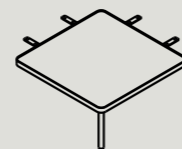

AT-310-D  
W 675 D 675 H 310  
W 26.6" D 26.6" H 12.2"



**ADAPT**  
PIVOTING TABLE

Flexible, inviting and productive, the Adapt collection of lounges and accessories are designed to evolve with the dynamic needs of today's workspace. Designed to interconnect with the Adapt Lounges and Ottomans, the Adapt Pivoting Table can be easily installed on the underside of the lounge to provide a working table-top surface, perfect for laptop use. The table can pivot horizontally allowing the user to position the table as desired, as well as providing easy ingress/egress.

For effortless application the Pivoting Table can be mounted on any Adapt Lounge module variation, either on the left- or right-hand side or specific locations along the longer lounges.

AVAILABLE TOP FINISHES



BLACK POWDER COAT MDF

WHITE POWDER COAT MDF

AVAILABLE BASE FINISHES



BLACK POWDER COAT

WHITE POWDER COAT

CUSTOM POWDER COAT

DIMENSIONS



T-350-T  
Ø350 H 485  
Ø13.8" H 19.1"