



Bed made of veneered multilayer with headboard framed by an iron structure and bed sides in solid wood.

**STANDARD VERSION:** ADJUSTABLE SLATTED BASE; UPON REQUEST FIXED SLATTED BASE AT THE SAME PRICE (for further information please contact our Sales Department); IRON BASE AND HEADBOARD FRAME LACQUERED IRONDUST COLOUR (B2)

RIALTO BED 1 DOUBLE				
CODE	SIZE	A1	A2	A3
RIALTO BED 1 DOUBLE	total size W 174 x D 213 x H 90,5 space for slatted base W 162 x D 202 suggested mattress W 160 x D 200	■	■	■
	total size W 184 x D 213 x H 90,5 space for slatted base W 172 x D 202 suggested mattress W 170 x D 200	■	■	■
	total size W 194 x D 213 x H 90,5 space for slatted base W 182 x D 202 suggested mattress W 180 x D 200	■	■	■
	total size W 214 x D 213 x H 90,5 space for slatted base W 202 x D 202 suggested mattress W 200 x D 200	■	■	■

**AVAILABLE FINISHES:**

- A1:** walnut without knots, walnut with knots, elm
- A2:** oak without knots, oak with knots, cherry, maple
- A3:** oak without knots finish: whitened, mystic black, neutro  
oak with knots finish: whitened, mystic black, neutro

# RIALTO BED 1

**STANDARD VERSION:** ADJUSTABLE SLATTED BASE; UPON REQUEST FIXED SLATTED BASE AT THE SAME PRICE (for further information please contact our Sales Department); IRON BASE AND HEADBOARD FRAME LACQUERED IRONDUST COLOUR (B2)

## RIALTO BED 1 FRENCH / SINGLE

CODE	SIZE	A1	A2	A3
RIALTO BED 1 SINGLE	total size W 114 x D 213 x H 90,5 space for slatted base W 102 x D 202 suggested mattress W 100 x D 200	■	■	■
RIALTO BED 1 FRENCH	total size W 154 x D 213 x H 90,5 space for slatted base W 142 x D 202 suggested mattress W 140 x D 200	■	■	■

### AVAILABLE FINISHES:

**A1:** walnut without knots, walnut with knots, elm

**A2:** oak without knots, oak with knots, cherry, maple

**A3:** oak without knots finish: whitened, mystic black, neutro  
oak with knots finish: whitened, mystic black, neutro

### FEASIBILITY LACQUERED IRON BASE AND HEADBOARD FRAME

B2	■
B3	■

### AVAILABLE FINISHES:

**B2:** lacquered iron: irondust, RAL (only selected colours)

**B3:** lacquered iron matt brushed effect: aged copper, aged bronze, stainless steel, titanium  
lacquered iron oxidised effect

RIALTO BED 1 DOUBLE - RIALTO BED 1 FRENCH

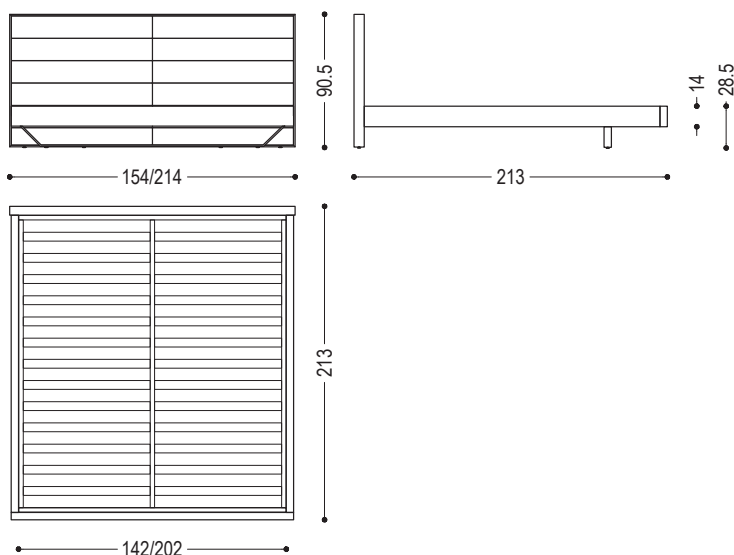

RIALTO BED 1 SINGLE

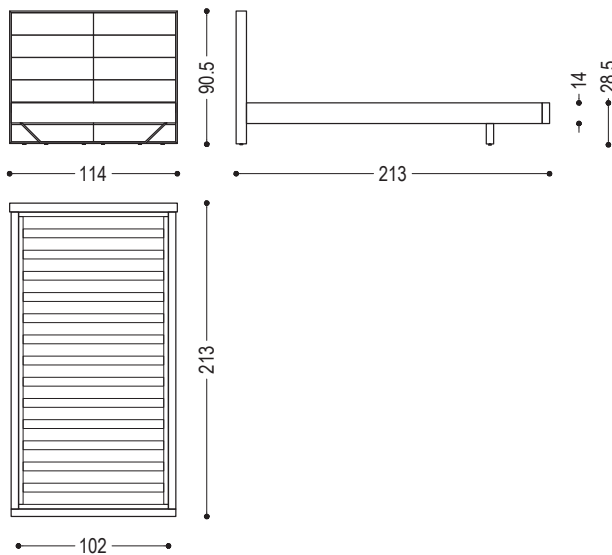

# RIALTO BED 1 | AVAILABLE FINISHES

## WOOD

A1

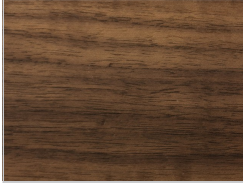

walnut without knots



walnut with knots



elm

A2



oak without knots



oak with knots



cherry



maple

A3



oak without knots finish:  
whitened



oak without knots finish:  
mystic black



oak without knots finish:  
neutro



oak with knots finish:  
whitened













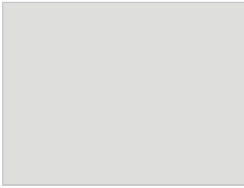

oak with knots finish:  
mystic black

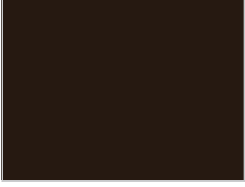
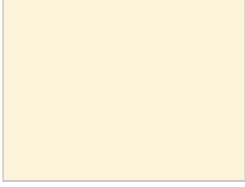
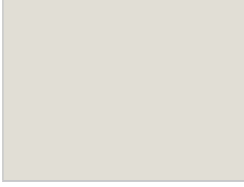

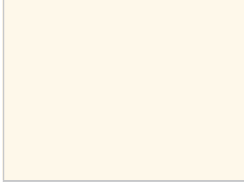
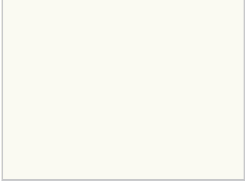
oak with knots finish:  
neutro

# RIALTO BED 1 | AVAILABLE FINISHES

## IRON

B2					
	lacquered iron: iron dust	ferro laccato: RAL - 1013_OYSTER WHITE	ferro laccato: RAL - 3020_TRAFFIC RED	ferro laccato: RAL - 7035_LIGHT GREY	ferro laccato: RAL - 7037_DUSTY GREY
					
	ferro laccato: RAL - 8019_GREY BROWN	ferro laccato: RAL - 9001_CREAM WHITE	ferro laccato: RAL - 9002_GREY WHITE	ferro laccato: RAL - 9005_JET BLACK	ferro laccato: RAL - 9010_PURE WHITE
					
	ferro laccato: RAL - 9016_TRAFFIC WHITE				
B3					
	lacquered iron, matt brushed effect: aged copper	lacquered iron, matt brushed effect: aged bronze	lacquered iron, matt brushed effect: stainless steel	lacquered iron, matt brushed effect: titanium	lacquered iron, oxidised effect