



Low glass cabinet with solid wood structure characterized by glass doors, sides and internal shelves. Fix middle shelf in wood. Available with 2 or 4 glass doors, with internal or external drawers, and iron base. Innovative LED system with spots, with independent activation and wireless charging.

**STANDARD COMPOSITION:** SEE TECHNICAL DRAWINGS

**ADDITIONAL ACCESSORIES:** SEE TECHNICAL NOTES

**STANDARD VERSION:** DOORS, SIDES AND SHELVES IN CLEAR GLASS (E1); IRON BASE LACQUERED IRONDUST COLOUR (B2); HANDLES FR80

CODE	SIZE	A1	A2	A3	A4	A5
ADA 1.1	W.198 x D.48 x H.85	■	■	■	■	■
ADA 1.2	W.198 x D.48 x H.85	■	■	■	■	■
ADA 1.3	W.198 x D.48 x H.85	■	■	■	■	■

**AVAILABLE FINISHES:**

- A1: walnut without knots, elm
- A2: oak without knots, cherry, maple
- A3: oak without knots finish: whitened, mystic black, vintage, neutro
- A4: oak without knots pigmented: white milk, total black
- A5: oak: with knots tobacco

FEASIBILITY GLASS OPTIONS	ADA 1.1	ADA 1.2	ADA 1.3
E1	■	■	■
E2	■	■	■
E3	■	■	■

**AVAILABLE FINISHES:**

- E1: glass: clear / extra clear, satin
- E2: glass: smoked, bronzed
- E3: lacquered glass (only selected RAL colours)

FEASIBILITY LACQUERED IRON BASE AND HARDWARE	
B2	■
B3	■

**AVAILABLE FINISHES:**

- B2: lacquered iron: iron dust, RAL (only selected colours)
- B3: lacquered iron matt brushed effect: aged copper, aged bronze, stainless steel, titanium  
lacquered iron oxidised effect

FEASIBILITY BACK COVERED IN LEATHER	
D3	■

**AVAILABLE FINISHES:**

- D3: leather: cristal

# ADA 1.0

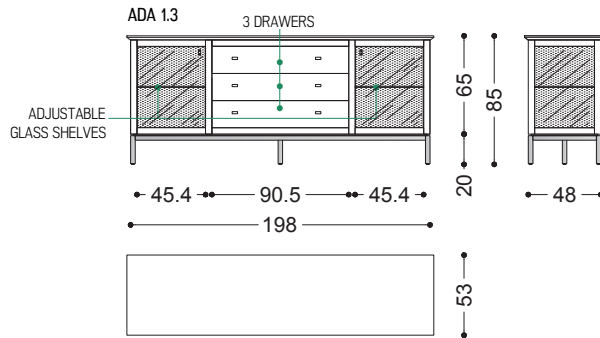
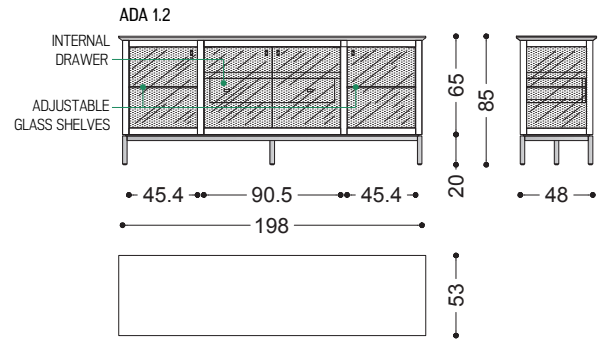
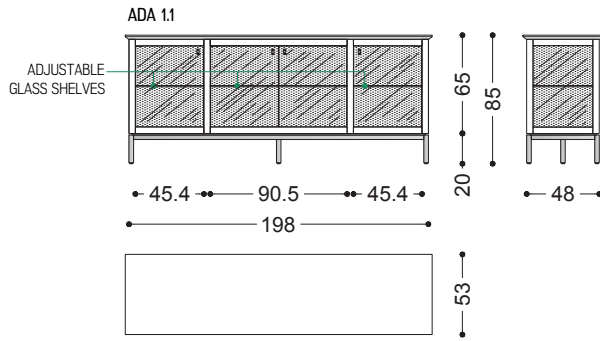

# ADA 1.0 | AVAILABLE FINISHES

## WOOD

A1



walnut without knots



elm

A2



oak without knots



cherry



maple

A3



oak without knots finish:  
whitened



oak without knots finish:  
mystic black



oak without knots finish:  
vintage



oak without knots finish:  
neutro

A4



oak without knots pigmented:  
white milk



oak without knots pigmented:  
total black

A5













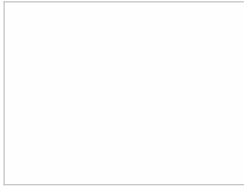

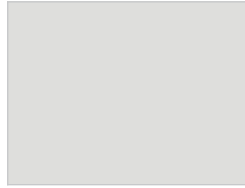
oak:  
with knots tabacco

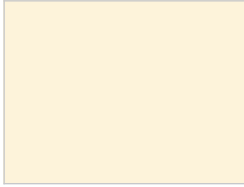
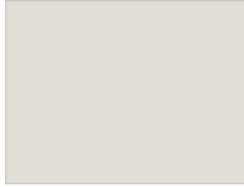
# ADA 1.0 | AVAILABLE FINISHES

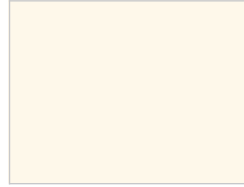
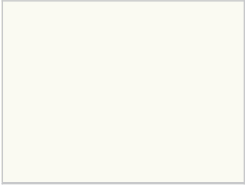





## LEATHER / FABRIC

D3					
	Leather cristal: 13	Leather cristal: 14	Leather cristal: 17	Leather cristal: 18	Leather cristal: 37
					
	Leather cristal: 49	Leather cristal: 51	Leather cristal: 65	Leather cristal: 70	

## IRON

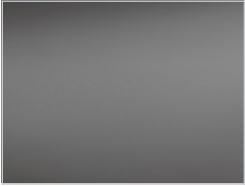
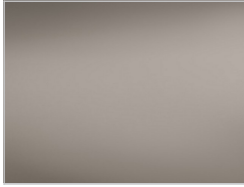
B2					
	lacquered iron: iron dust	ferro laccato: RAL - 1013_OYSTER WHITE	ferro laccato: RAL - 3020_TRAFFIC RED	ferro laccato: RAL - 7035_LIGHT GREY	ferro laccato: RAL - 7037_DUSTY GREY
					
	ferro laccato: RAL - 8019_GREY BROWN	ferro laccato: RAL - 9001_CREAM WHITE	ferro laccato: RAL - 9002_GREY WHITE	ferro laccato: RAL - 9005_JET BLACK	ferro laccato: RAL - 9010_PURE WHITE
					
	ferro laccato: RAL - 9016_TRAFFIC WHITE				
B3					
	lacquered iron, matt brushed effect: aged copper	lacquered iron, matt brushed effect: aged bronze	lacquered iron, matt brushed effect: stainless steel	lacquered iron, matt brushed effect: titanium	lacquered iron, oxidised effect

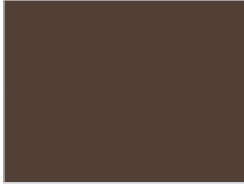
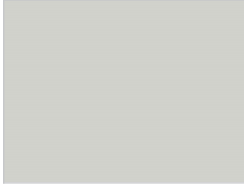
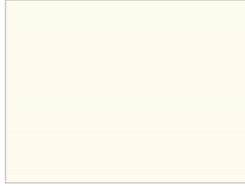
## GLASS

E1	 clear / extra clear glass	 satin glass			
	 smoked glass	 bronzed glass			
E3	 lacquered glass - 5022_NIGHT BLUE	 lacquered glass - 7004_SIGNAL GREY	 lacquered glass - 7013_BROWN GREY	 lacquered glass - 7035_LIGHT GREY	 lacquered glass - 9010_PURE WHITE
	 lacquered glass - 9011_GRAPHITE BLACK				

# PIECES OF FURNITURE | TECHNICAL NOTES

## DOORS AND DRAWERS OPENING SYSTEM

Add the following surcharge in case of non-standard opening system for drawers and doors.

SURCHARGE (price for one door/drawer)	
push-pull system	■
grooved handle	■

## CUTLERY TRAY

Trays can be customized upon request: feasibility and surcharge need to be confirmed by our sales department.  
Available finishes: walnut, oak, cherry, maple and elm.

CUTLERY DIVIDERS	
PP001 - for drawer W. 30 cm	■
PP002 - for drawer W. 60 cm	■
PP003 - for drawer W. 90 cm	■

**N.B.:**

Cutlery dividers laid in the drawer.

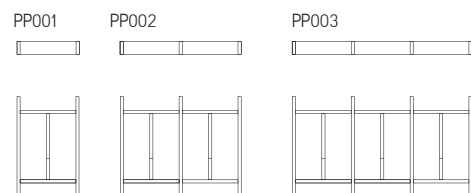

CUTLERY TRAY	
PP004 - for drawer W. 30 cm	■
PP005 - for drawer W. 60 cm	■
PP006 - for drawer W. 90 cm	■

**N.B.:**

Cutlery tray with lateral handles for easy use.

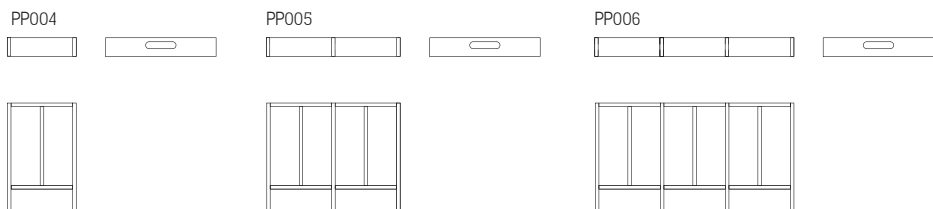

CUTLERY TRAY WITH CUTTING BOARD	
PPT001 - for drawer W. 60 cm	■

**N.B.:**

Cutlery tray with lateral handles for easy use, composed by: cutlery dividers, beech cutting board and knives holder.

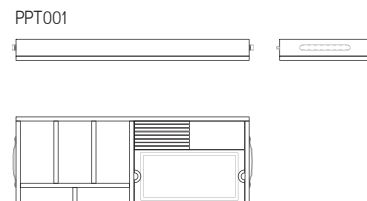

TRAY FOR FAR EAST ACCESSORIES	
SS001 - for drawer W. 60 cm	■

**N.B.:**

Set with dividers for far east kitchen with lateral handles for easy use.

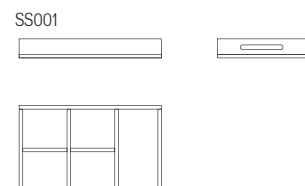

## DRAWER DIVIDERS

### WINE SET

Set for drawer with accessories for wine tasting (professional corkscrew, spare tips, steel cap, thermometer, pourer, drip ring, foil cutter).

Size W.29,5 x D.22,5 cm.

WINE SET	
walnut/oak	■
teak	■



### SPIRITS SET

Set for drawer with accessories for spirits tasting (4 small glasses and 4 marble chilling cubes).

Size W.20 x D.22,5 cm.

SPIRITS SET	
walnut/oak	■



## BOTTLE SPACES

Wooden grid for space with size W.56 x H.35 cm; depth of the grid around 33 cm.

Characterized by 9 spaces around 9x9 cm each, for bottles positioned horizontally, and one vertical module around W.19 x H.31 cm.

The grid can be customized upon request: feasibility and surcharge to be confirmed by our sales department.

BOTTLE SPACES	
walnut/oak	■



## GLASS HOLDERS

Composed by 3 stainless steel holders.

Holders L. 32 cm can hold max. 3 glasses with diameter of 8,5 cm, while holders L. 46,6 cm max. 4 glasses.

This set needs to be fixed to the top shelf or to another fixed shelf.

For more details please check the technical drawing.

Upon request:

- available in other sizes.
- position of the 3 elements at different distance.

GLASS HOLDERS	
set 3 elements L.32 cm	■
set 3 element L.46,6 cm	■

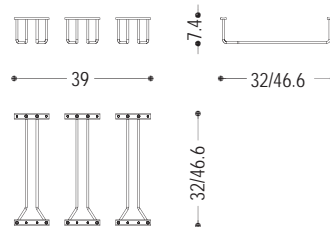

GLASS HOLDER ELEMENTS

