

ROSS GARDAM

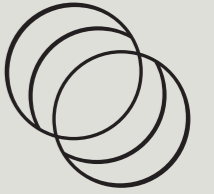

Flexible, inviting and productive, the Adapt collection of lounges and accessories are designed to evolve with the dynamic needs of today's workspace.



The clean lines and subtle surfaces of the Adapt bring a softness and sense of the familiar into the workspace. Offering a diverse range of possible compositions ensures a cohesive design language can be created in any fitout. Adapt is made in Melbourne and was designed by Ross Gardam to perfectly service multiple sectors and applications.



With the ever changing demands of workspaces, Adapt is designed to transform with the individual needs of the space.





Adapt's modular nature allows components to be easily reconfigured, creating solutions now and for the future.

Based around five core elements with an economical base unit measuring 680 × 680mm (26.8" × 26.8"), each can sit alone or combine to create larger spaces in straight or curved configurations. The elements can be added to by simply attaching arms, backs, mid-height or full-height screens, desks and tables, creating near limitless possibilities.

A truly modular system with functionality at its core, Adapt caters for offices, receptions, universities, airports and hospitality spaces. Conceived for both small and large open-plan spaces, the collection can transform from small booths for study to large team training areas and anything in-between.

DESIGN FEATURES ⁰¹

The design intent was to 'create a functional commercial product with residential junctions'. The breadth of functionality is a response to the demanding and complex environments of use. Adapt is compact but provides a high level of comfort with its well defined internal proportions.



SOFTNESS

A 50mm radius is used throughout to soften the overall appearance and to make the collection approachable and inviting. An overstated French seam features heavily to bring a relaxed nature to the overall design.



PRIVACY

With the addition of a mid-height screen the Adapt transforms into a more private space, a haven in busy environments. The option of a full-height screen creates total visual privacy and can provide a refuge for study and concentration.

CONNECTION

Each screen features nodes enabling a simple installation process while creating a defined visual language that continues through to the lounge, table and desk legs.



TENSION

A visual tension between cushions, a soft radius and a seam detail are all designed to create a distinctly residential design language paired with a high level of comfort.

ADAPTABILITY ⁰²

Adapt consists of five core elements as shown below. Each can sit alone or combine in a modular configuration. Arms, backs, screens, desks and tables can be added or removed simply and easily on-site. The versatility this enables is illustrated to the right using one of the five core elements and additions.

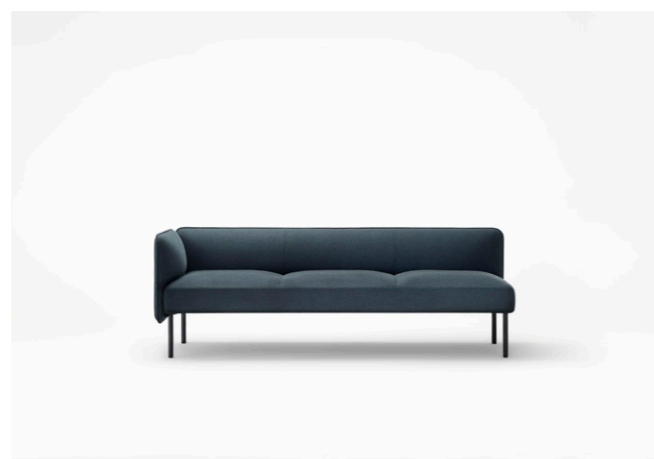
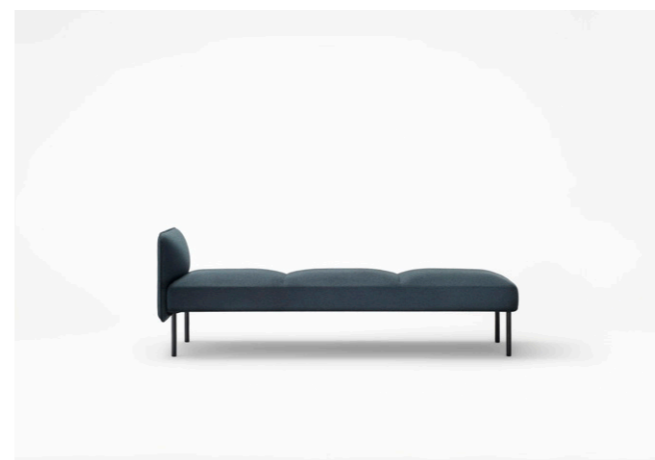
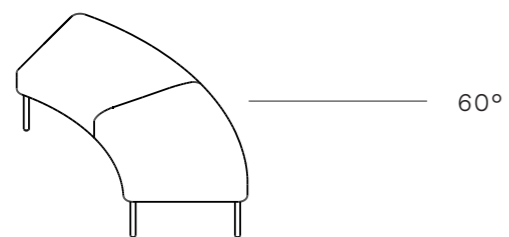
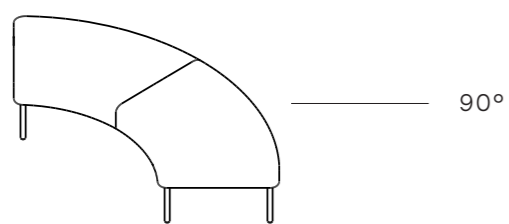
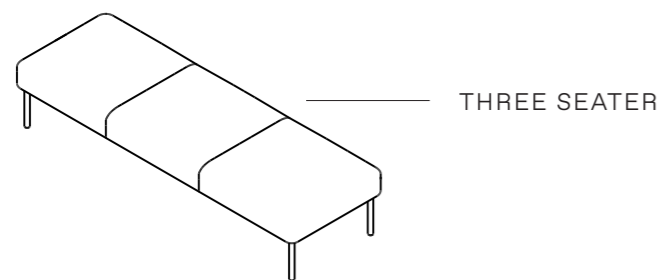
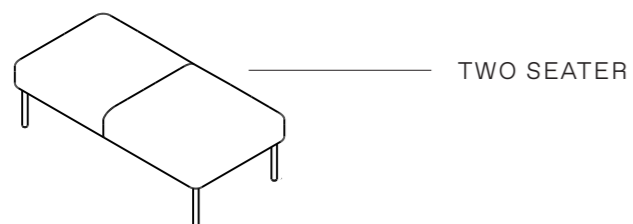



With the addition of two types of curved elements, a 60° and 90° module, distinct break-out, meeting and training spaces can be created in a variety of configurations.

EXAMPLE CONFIGURATIONS ⁰³

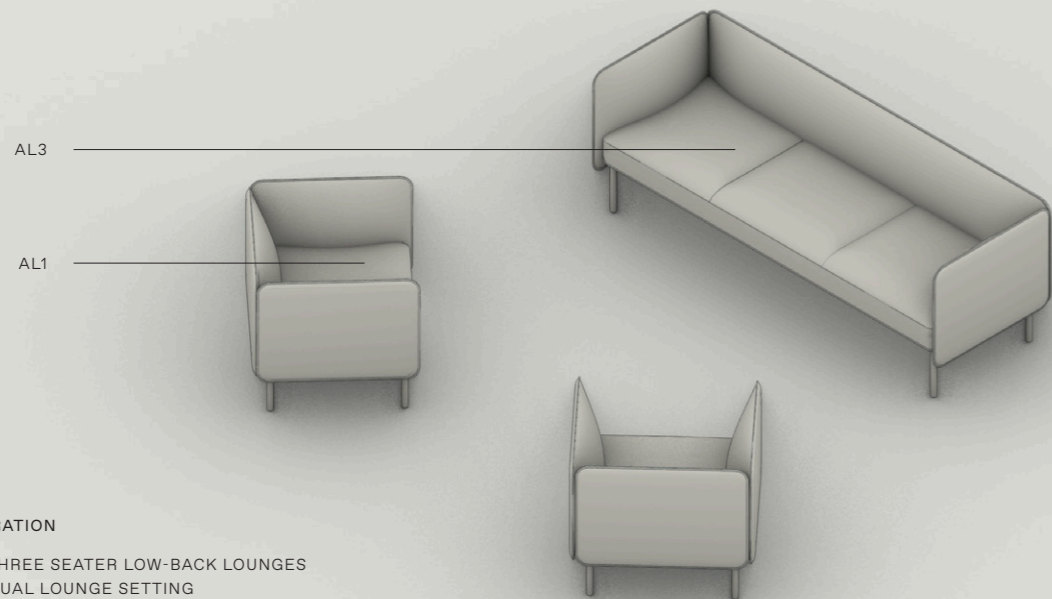

01 / CONFIGURATION

SINGLE AND THREE SEATER LOW-BACK LOUNGES
CREATE A CASUAL LOUNGE SETTING

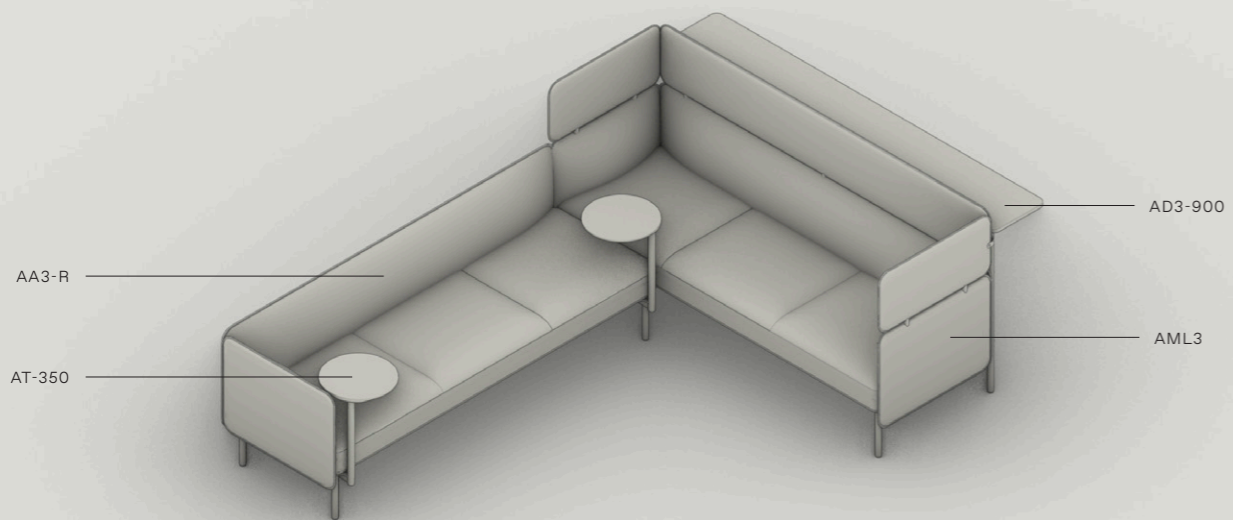

02 / CONFIGURATION

LOUNGES CAN BE JOINED TOGETHER TO CREATE
LARGER CONFIGURATIONS OF VARYING HEIGHTS

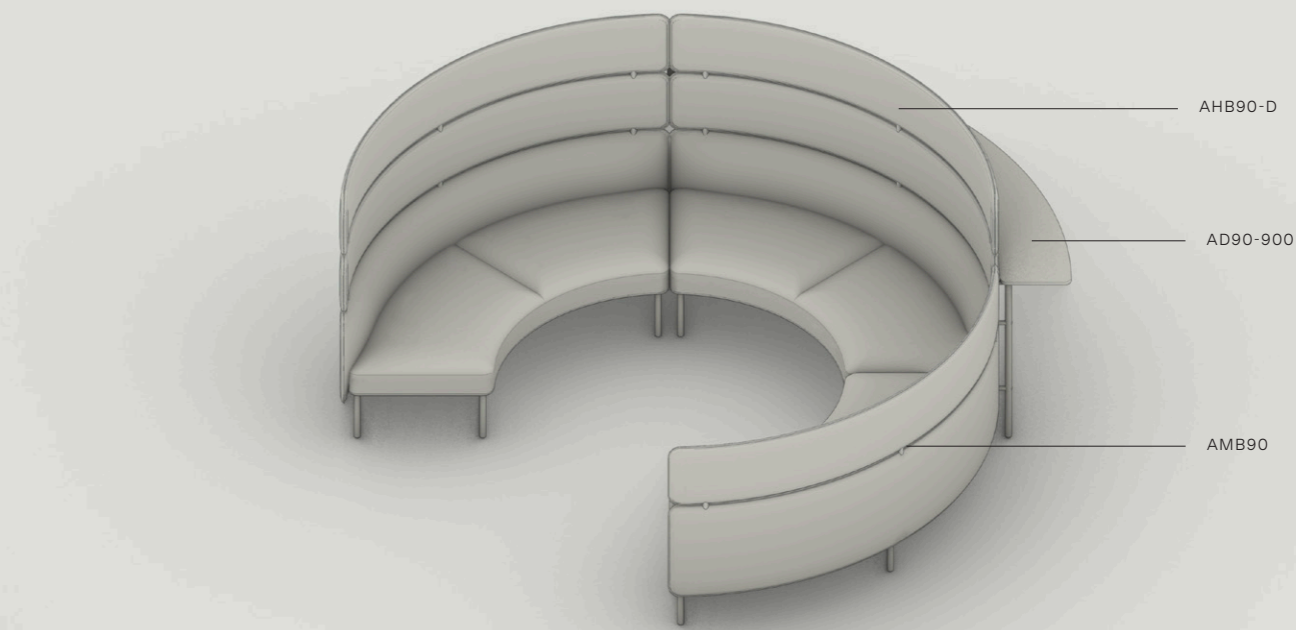

03 / CONFIGURATION

JOINING 90 DEGREE LOUNGES CAN CREATE CLOSE
MEETING SPACES WITH REAR DESKS PROVIDING
ADDITIONAL WORKING SPACES

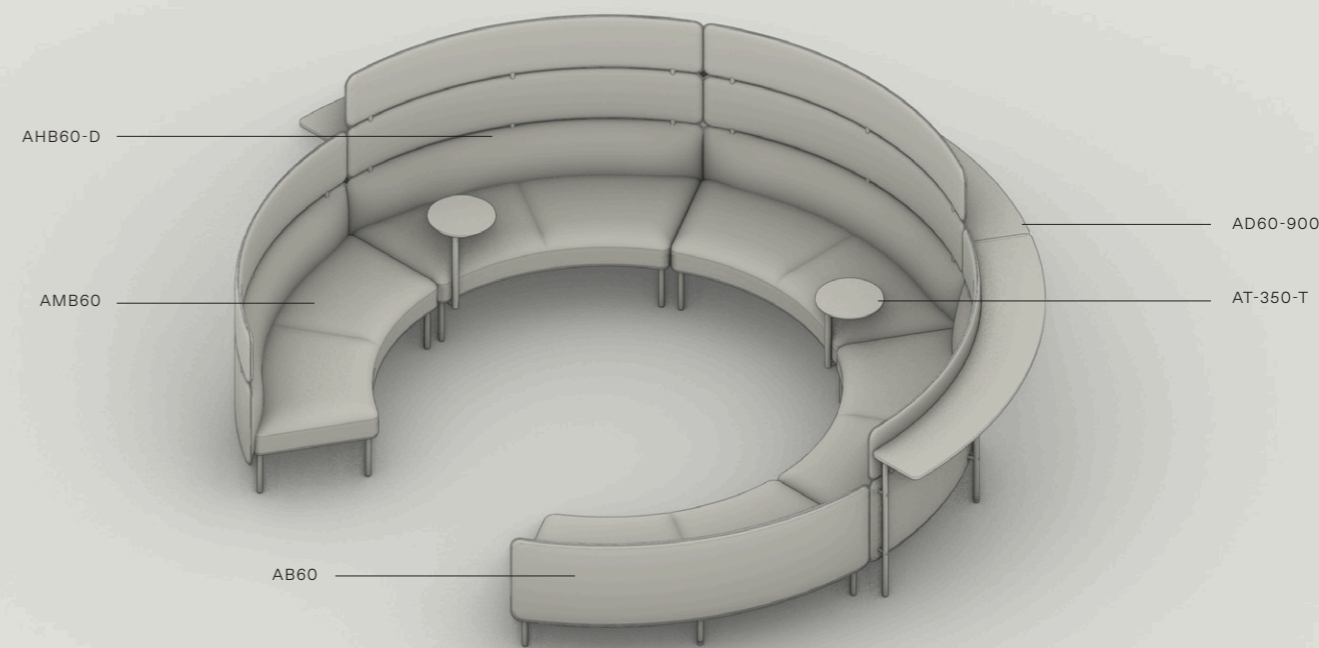

04 / CONFIGURATION

LARGER 60 DEGREE LOUNGES PROVIDE MORE
SPACIOUS MEETING SPACES OR PLACES FOR
WORKING WITH PIVOTING TABLES ENABLING
MOVABLE WORK SURFACES

05 / CONFIGURATION

HIGH-BACK LOUNGES AVAILABLE IN SINGLE SCREEN OR DOUBLE-SCREEN VARIATIONS - BOTH WITH THE SAME HEIGHT

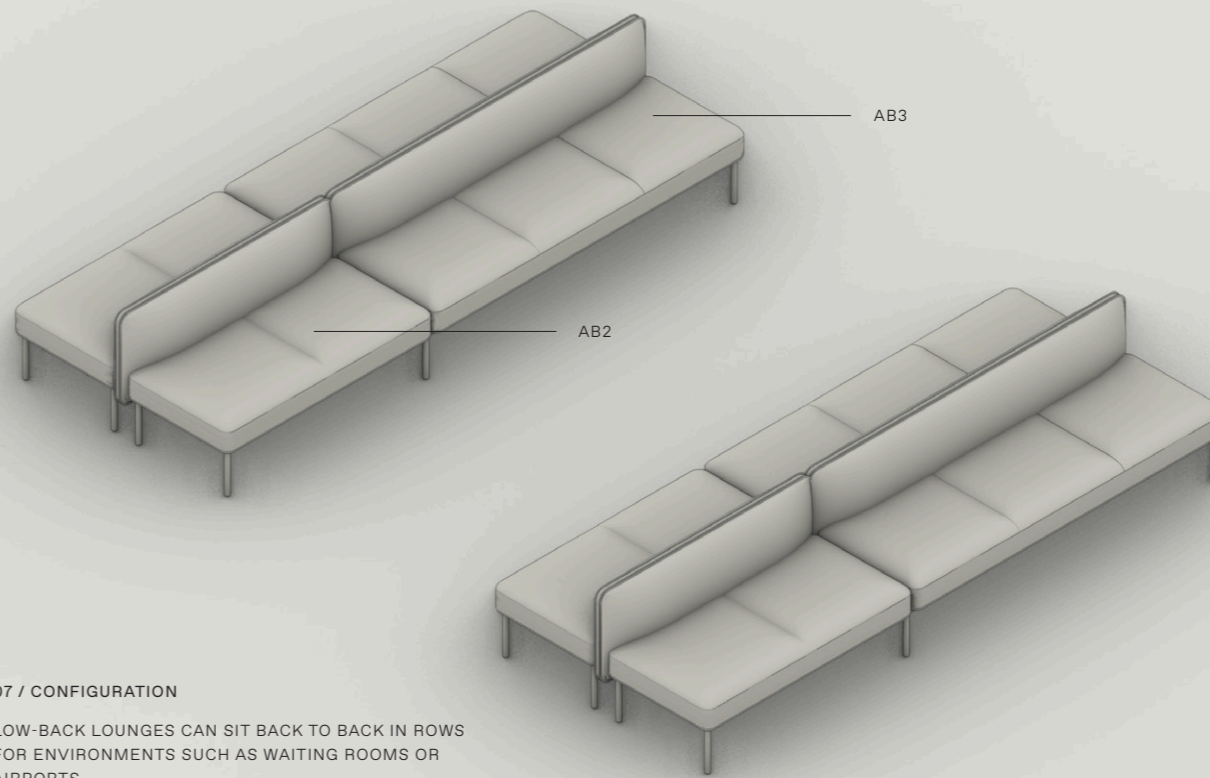
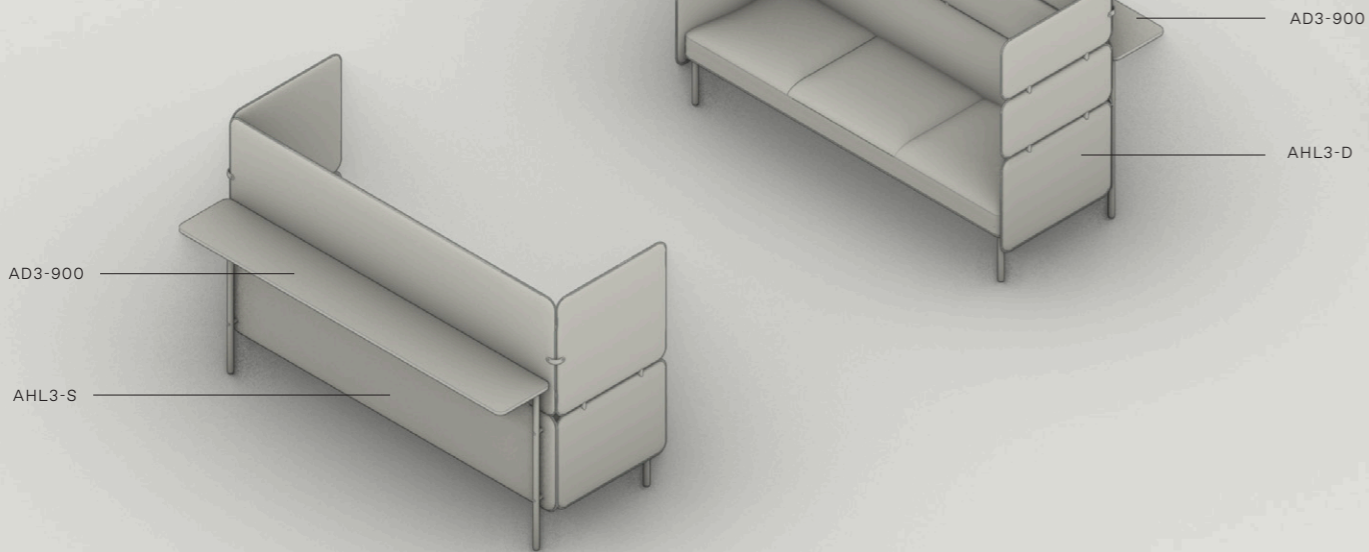

07 / CONFIGURATION

LOW-BACK LOUNGES CAN SIT BACK TO BACK IN ROWS FOR ENVIRONMENTS SUCH AS WAITING ROOMS OR AIRPORTS

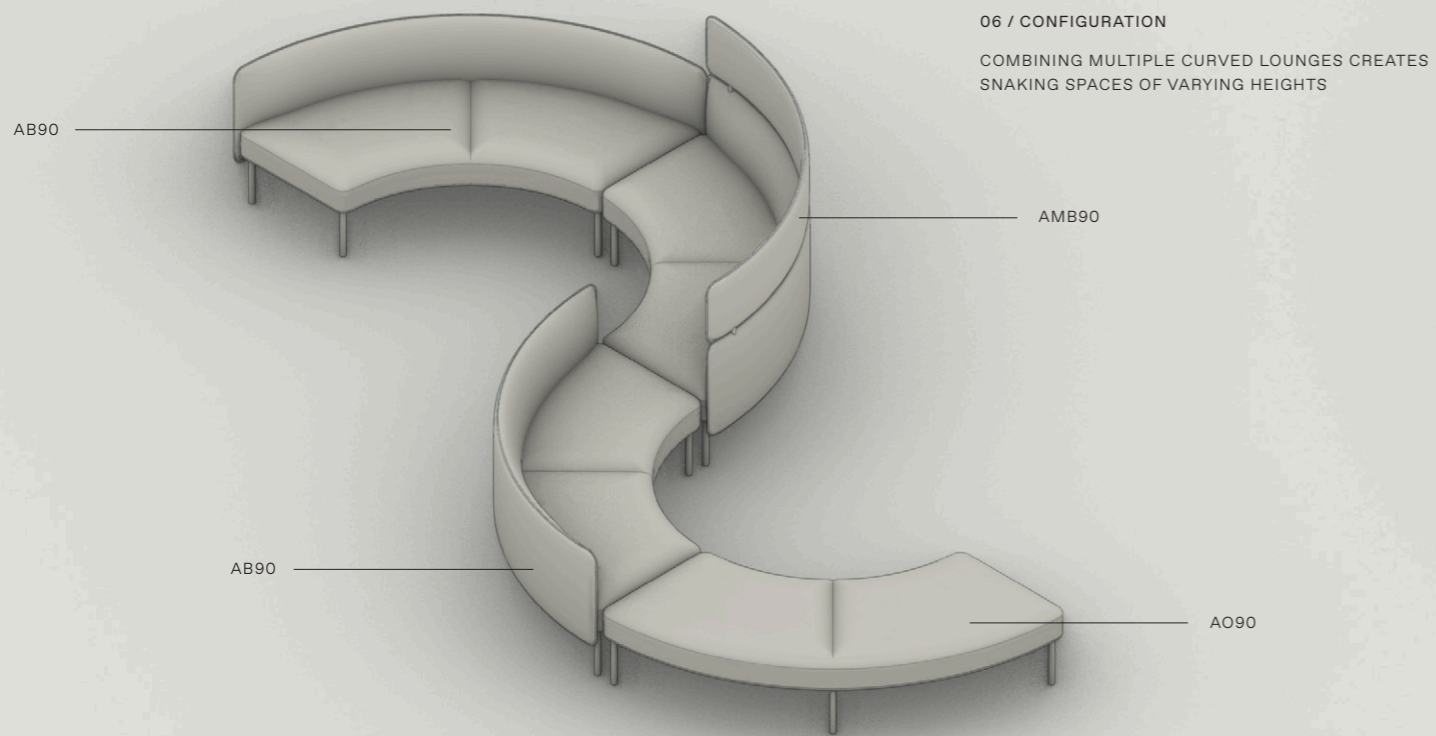

06 / CONFIGURATION

COMBINING MULTIPLE CURVED LOUNGES CREATES SNAKING SPACES OF VARYING HEIGHTS

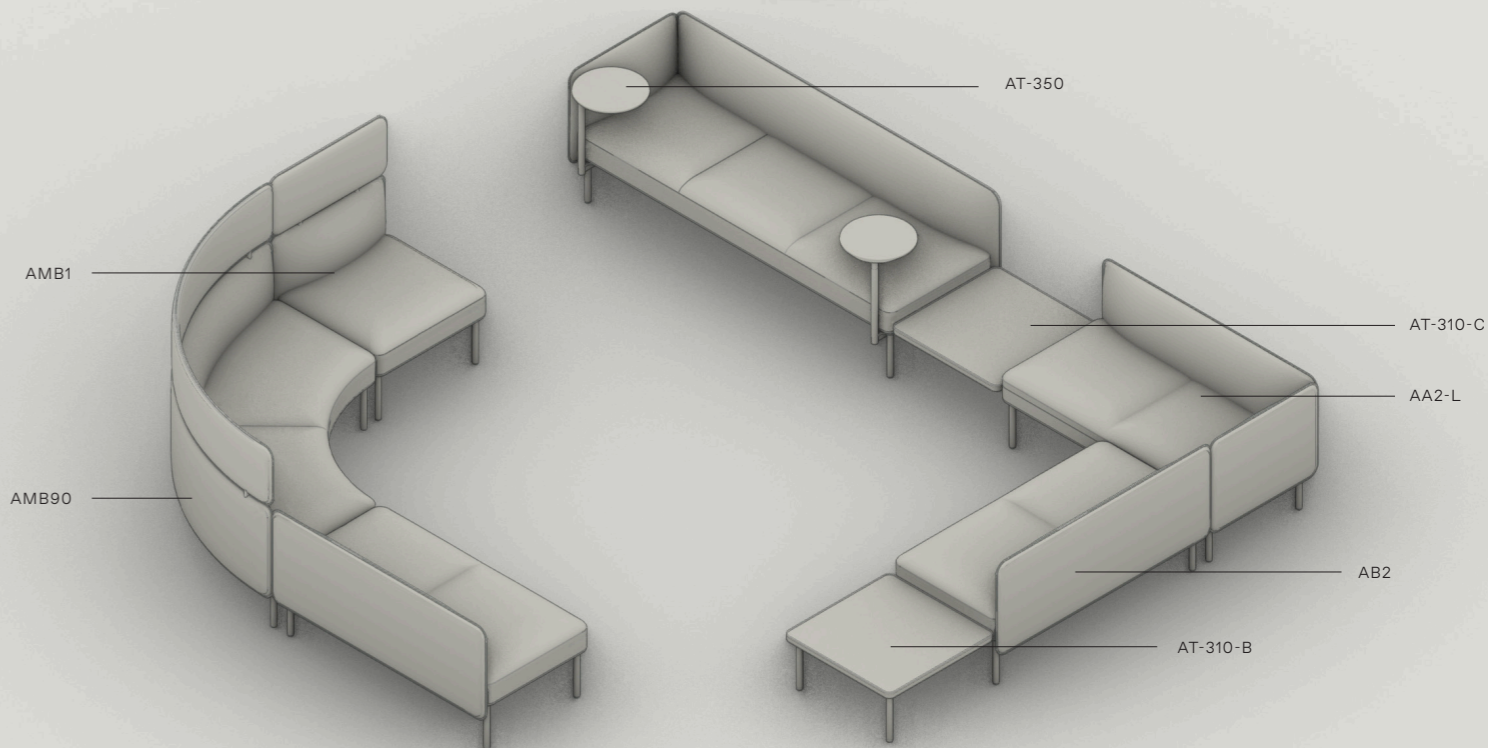

08 / CONFIGURATION

OPEN PLAN SEATING USING STRAIGHT AND CURVED UNITS WITH SIDE TABLES USED TO BREAK UP THE SPACES

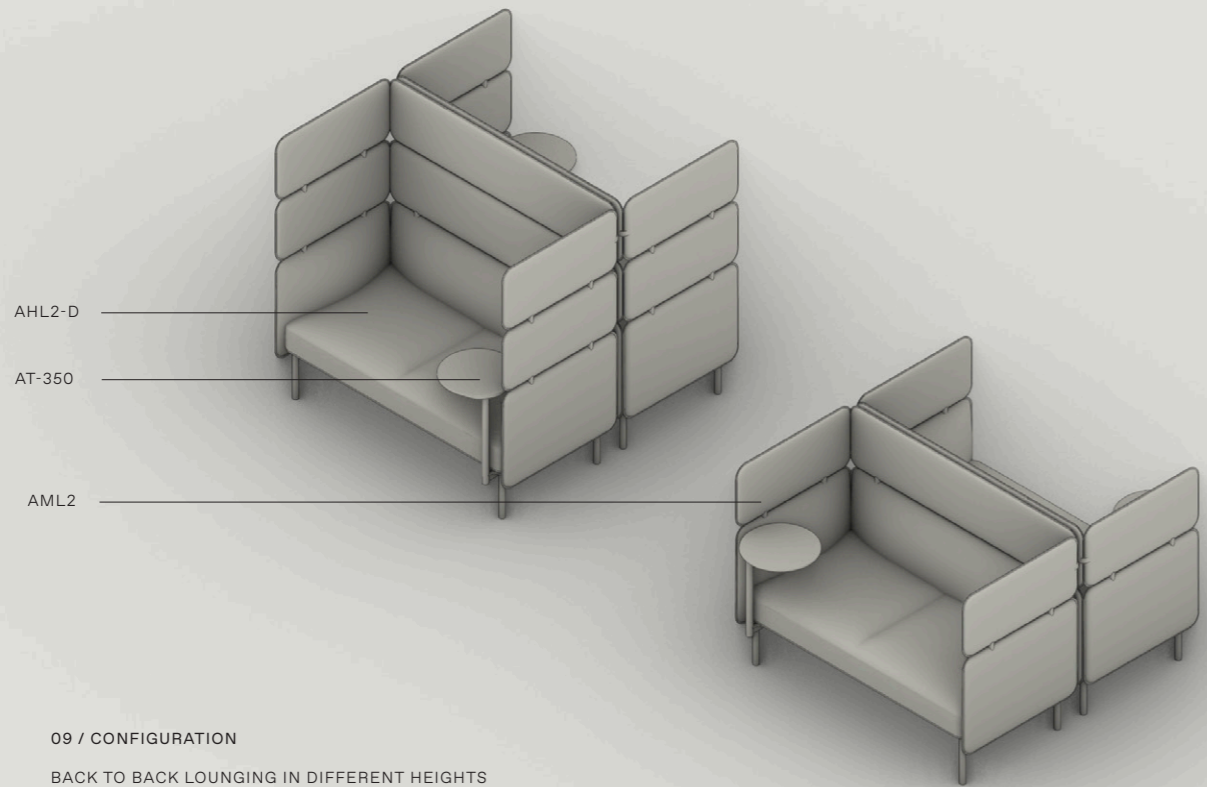

AHL2-D
 AT-350
 AML2

09 / CONFIGURATION
 BACK TO BACK LOUNGING IN DIFFERENT HEIGHTS
 WITH PIVOTING TABLES FOR WORKING

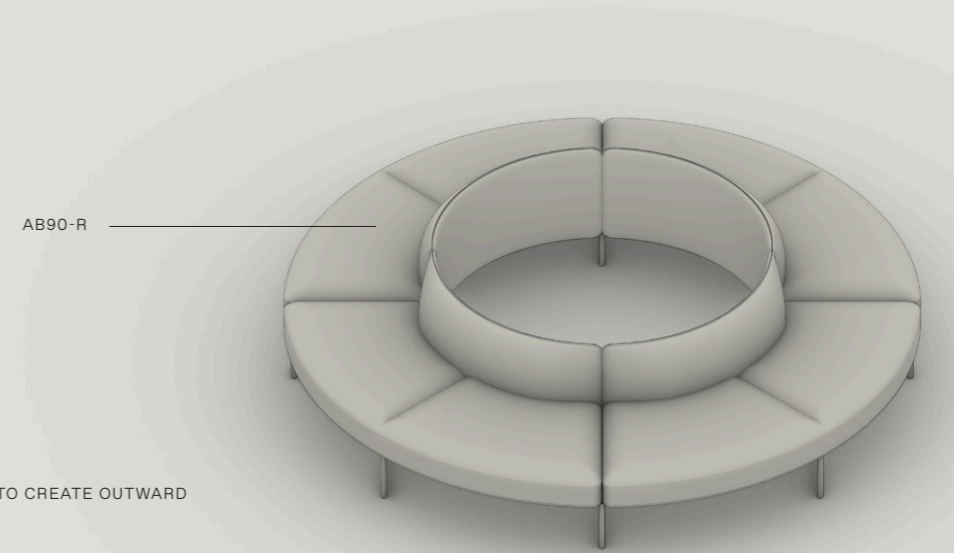

AB90-R

11 / CONFIGURATION
 USING REVERSE CURVED UNITS TO CREATE OUTWARD
 ISLAND SEATING

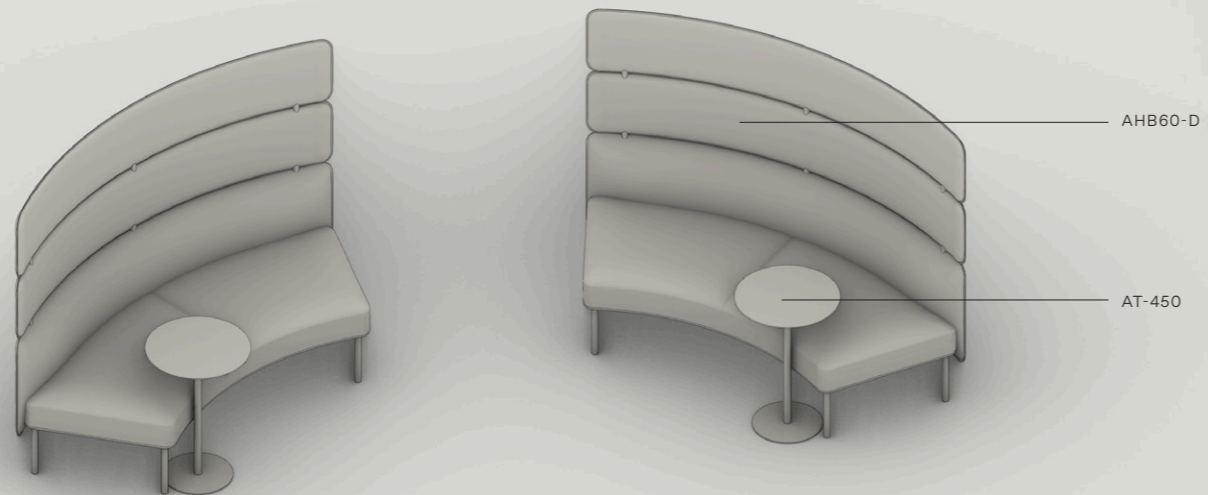

AHB60-D
 AT-450

10 / CONFIGURATION
 CURVED LOUNGES THAT CAN BE JOINED FOR
 INTIMATE MEETINGS OR SEPARATED FOR MORE
 PRIVATE WORK SPACES

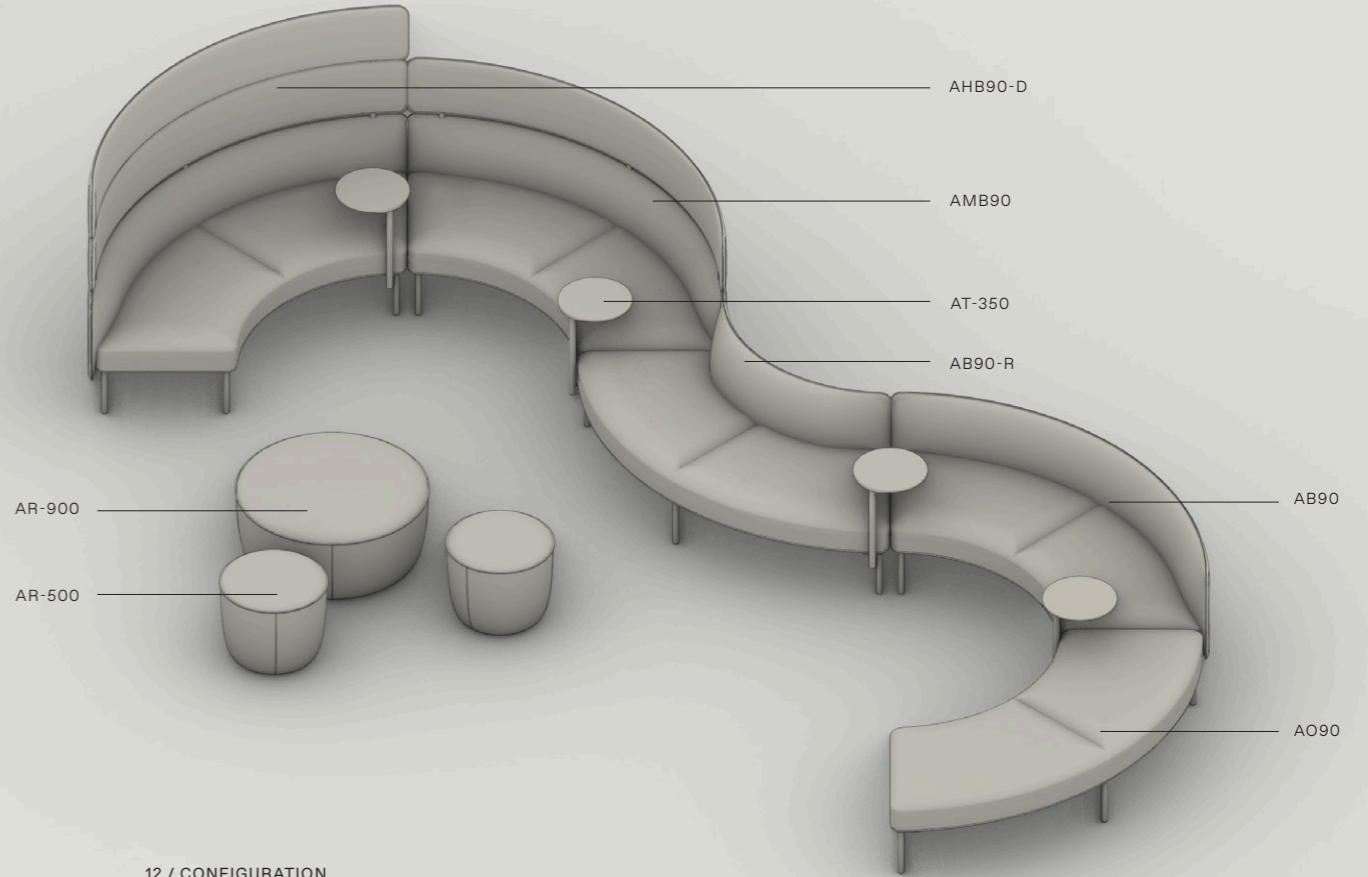

AHB90-D
 AMB90
 AT-350
 AB90-R
 AB90
 A090
 AR-900
 AR-500

12 / CONFIGURATION
 COMBINING CURVED AND REVERSE CURVED UNITS
 TO ENABLE SEATING ON ONE CONTINUOUS SIDE

TABLES ⁰⁴

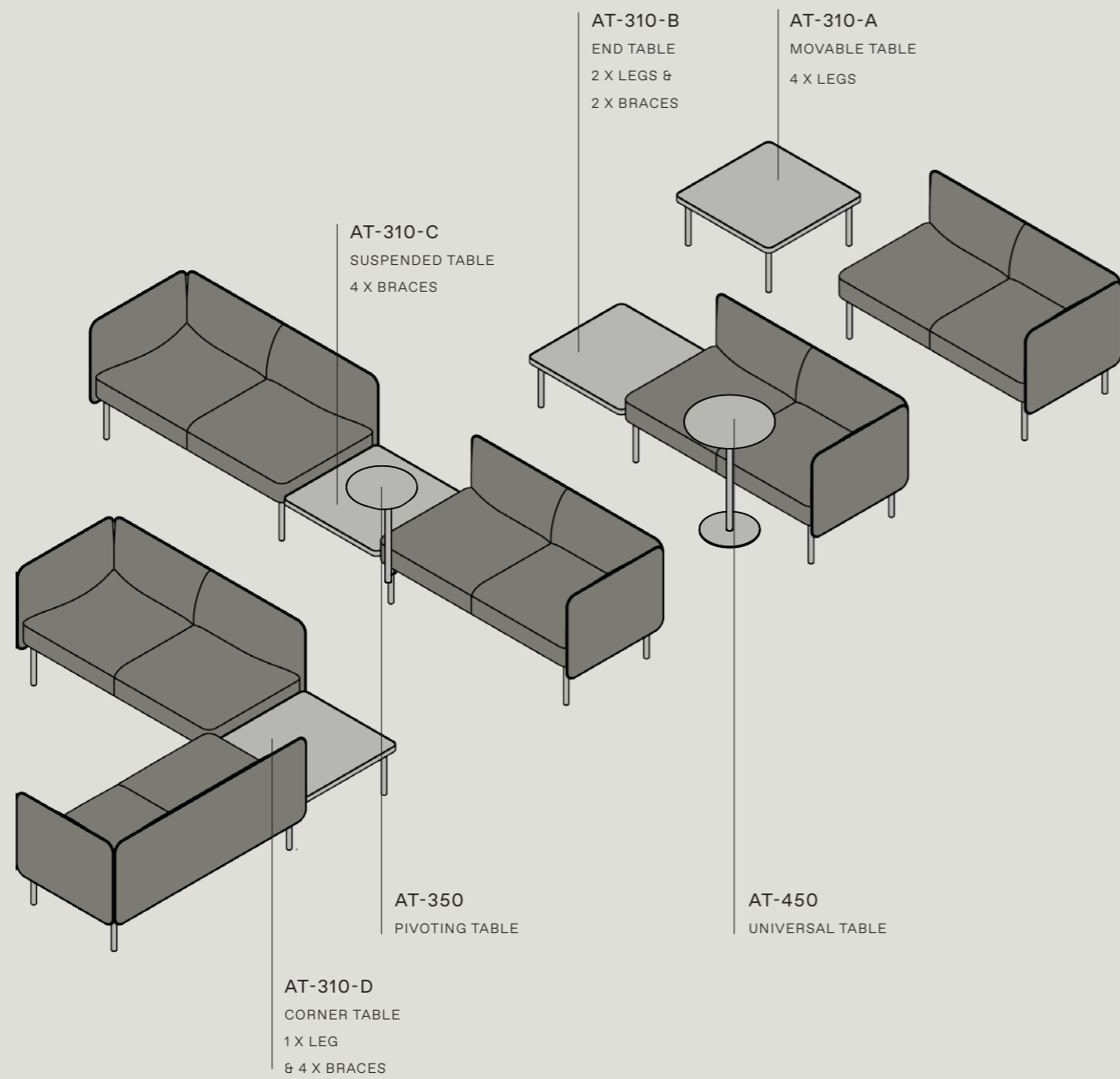

The **Adapt Side Table** is designed for use in various configurations. Refer to above arrangements for available table locations and required leg and brace quantities for each table type.

The **Adapt Pivoting Table** attaches to the lounge underside and pivots horizontally to position as desired while the **Universal Table** is a mobile working surface that can be moved and used in all seating locations.

POWER ⁰⁵

UNDER LOUNGE

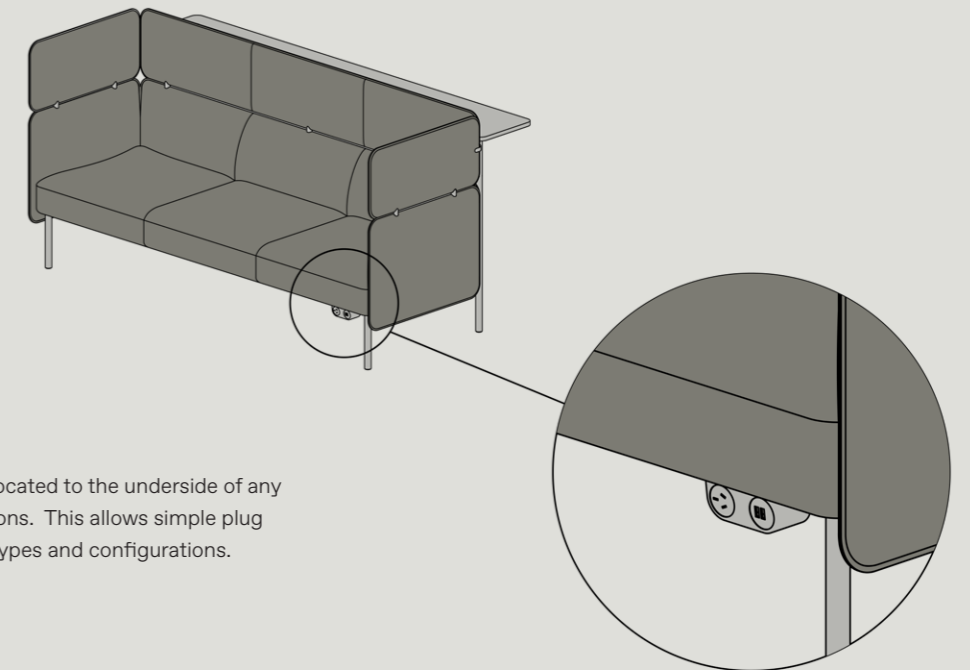

A power / USB module can be located to the underside of any of the lounge or ottoman options. This allows simple plug and play with any lounge types and configurations.

BACK OF LOUNGE

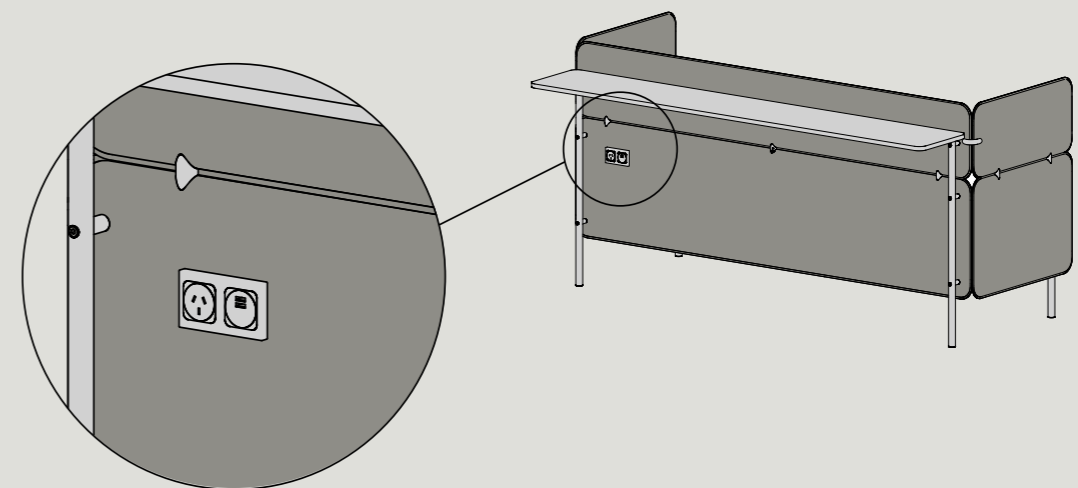

A built-in power / USB module can be located directly into the rear of any back. This offers an ideal location to power up while using the rear desks of the Adapt collection.

DETAILS 06

JOINING LEG

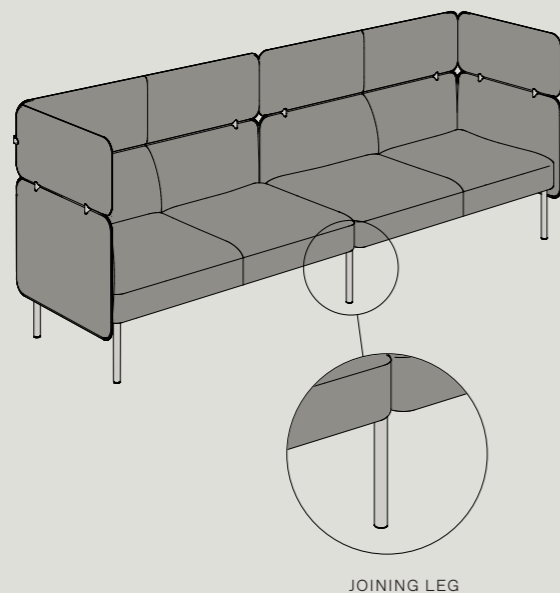

The **Joining Leg** can be used to join multiple modules together in a banquet-style seating arrangement while reducing the amount of legs required in a setting. Used in place where both front and rear legs are to be joined. Note: lounges become permanently connected.

SUPPORT LEG

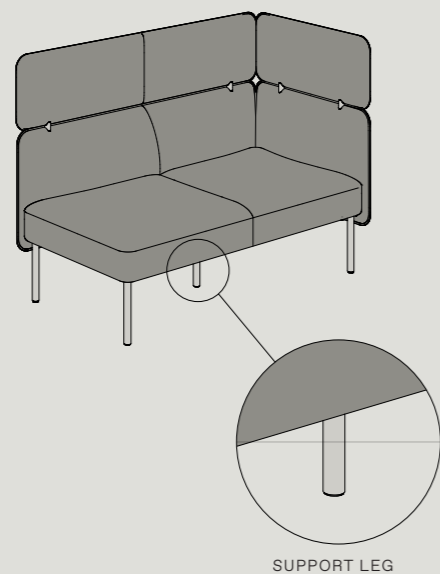

The **Support Leg** can be added to the centre underside of all 2 and 3 seater lounges, as well as 60° and 90° modules for additional structural strength where required.

STABILITY REQUIREMENTS

(HIGH-BACK LOUNGE ONLY)

Back-Only and *Single-Arm* High-Back straight modules should be supported from both ends with under lounge joiners and straight screen brackets. This can be achieved through joining to other modules with arms in an 'L' or linear configuration*.

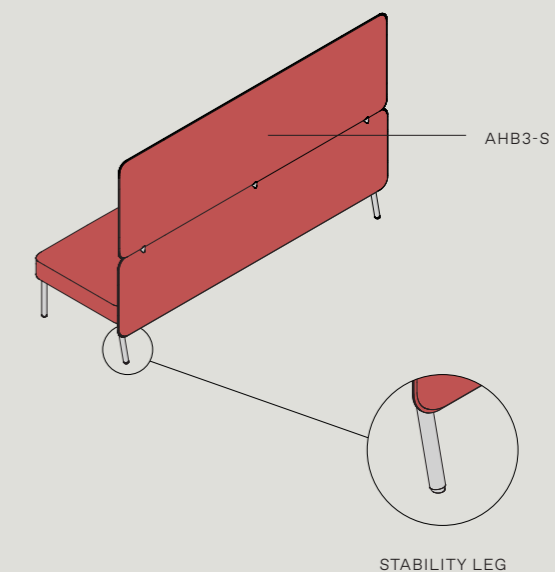
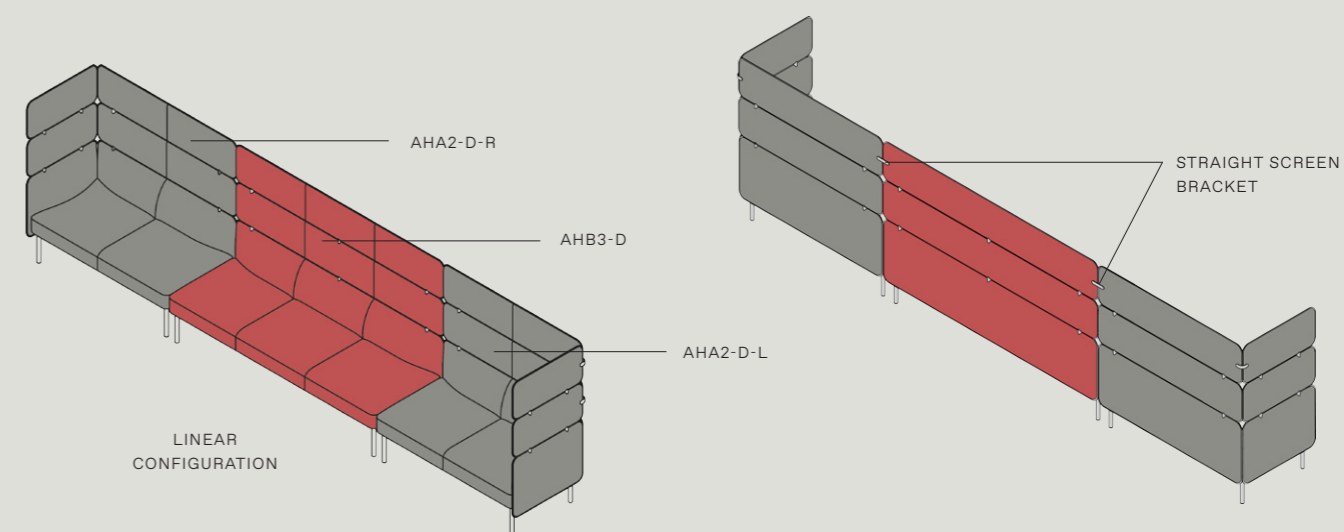
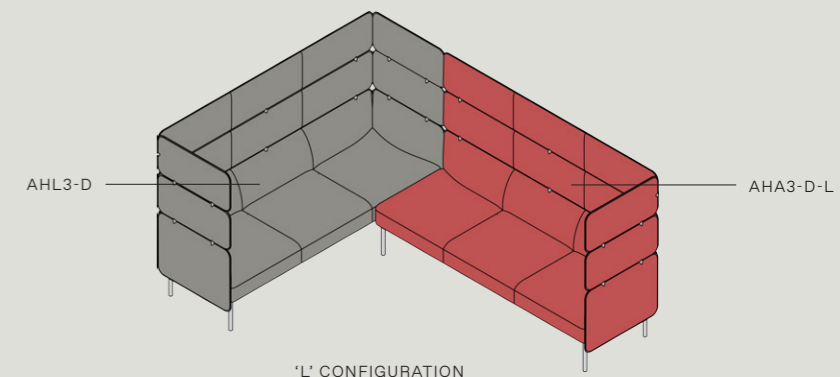

If High-Back straight modules are not supported from both ends, they will require angled **Stability Legs** (please get in contact for details).

*Note applies to Back-Only and Single-Arm High-Back straight modules only. Please see Specifications on following pages for applicable lounges.

SPECIFICATIONS ⁰⁷

ADAPT OTTOMAN

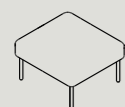

AO1
W 725 D 680 H 440

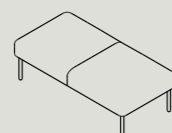

AO2
W 1360 D 680 H 440

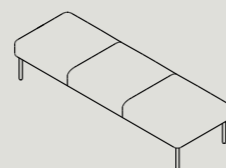

AO3
W 2040 D 680 H 440

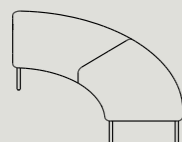

AO90
W 1480 D 1480 H 440 IR 800

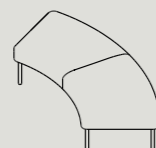

AO60
W 1610 D 1265 H 440 IR 1200

ADAPT LOW-BACK LOUNGE

WITH BACK

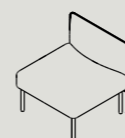

AB1
W 725 D 730 H 700 S 440

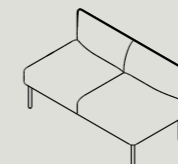

AB2
W 1360 D 730 H 700 S 440

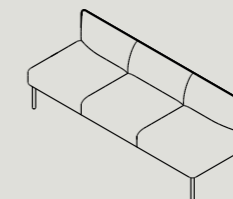

AB3
W 2040 D 730 H 700 S 440

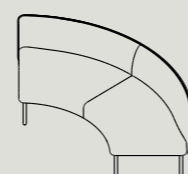

AB90
W 1530 D 1530 H 700
S 440 IR 800

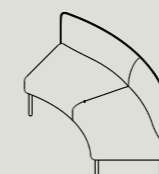

AB60
W 1660 D 1315 H 700
S 440 IR 1200

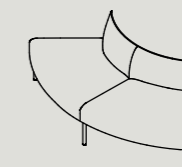

AB90-R
W 1480 D 1480 H 700
S 440 IR 800

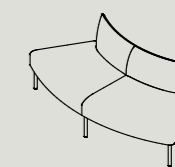

AB60-R
W 1610 D 1315 H 700
S 440 IR 1200

CORNER / WITH SINGLE ARM

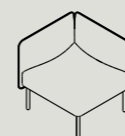

AC1-R/L*
W 730 D 730 H 700 S 440

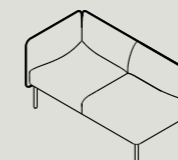

AA2-R/L*
W 1410 D 730 H 700 S 440

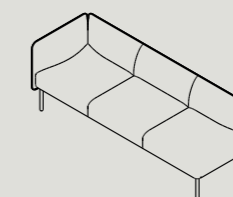

AA3-R/L*
W 2090 D 730 H 700 S 440

LOUNGE



AL1
W 825 D 730 H 700 S 440

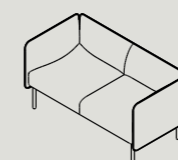

AL2
W 1460 D 730 H 700 S 440



AL3
W 2140 D 730 H 700 S 440

*R or L refers to Right or Left arm location. Arm location is defined while sitting on lounge. Dimensions shown in millimetres (mm) and are indicative. For projects requiring specific dimensions, please get in contact.

ADAPT MID-BACK LOUNGE

WITH BACK



AMB1
W 725 D 730 H 1025 S 440

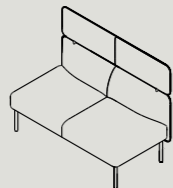

AMB2
W 1360 D 730 H 1025 S 440

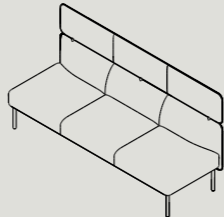

AMB3
W 2040 D 730 H 1025 S 440

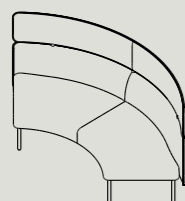

AMB90
W 1530 D 1530 H 1025
S 440 IR 800

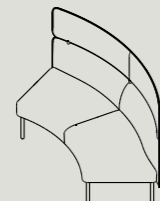

AMB60
W 1660 D 1315 H 1025
S 440 IR 1200

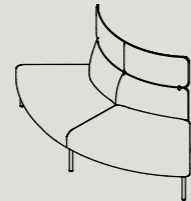

AMB90-R
W 1480 D 1480 H 1025
S 440 IR 800

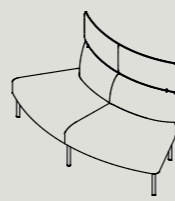

AMB60-R
W 1610 D 1315 H 1025
S 440 IR 1200

CORNER / WITH SINGLE ARM

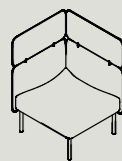

AMC1-R/L*^
W 730 D 730 H 1025 S 440

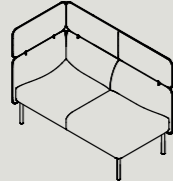

AMA2-R/L*
W 1410 D 730 H 1025 S 440

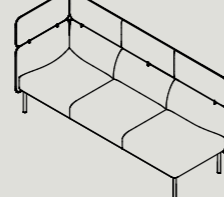

AMA3-R/L*
W 2090 D 730 H 1025 S 440

LOUNGE

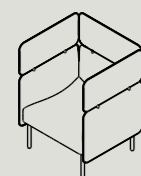

AML1
W 825 D 730 H 1025 S 440



AML2
W 1460 D 730 H 1025 S 440

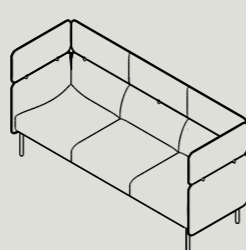

AML3
W 2140 D 730 H 1025 S 440

ADAPT HIGH-BACK (SINGLE SCREEN) LOUNGE

WITH BACK

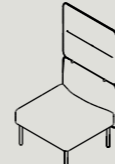

AHB1-S*
W 725 D 730 H 1350 S 440

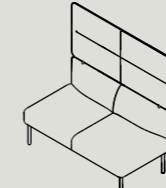

AHB2-S*
W 1360 D 730 H 1350 S 440

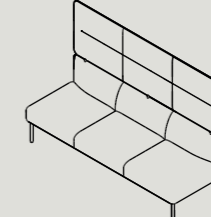

AHB3-S*
W 2040 D 730 H 1350 S 440

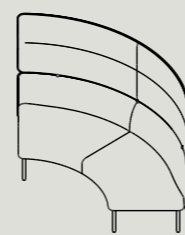

AHB90-S
W 1530 D 1530 H 1350
S 440 IR 800



AHB60-S
W 1660 D 1315 H 1350
S 440 IR 1200

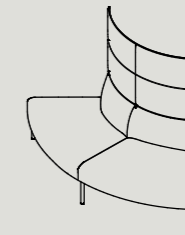

AHB90-R-S
W 1480 D 1480 H 1350
S 440 IR 800

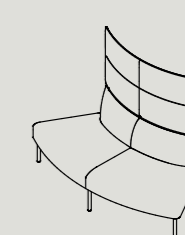

AHB60-R-S
W 1610 D 1315 H 1350
S 440 IR 1200

CORNER / WITH SINGLE ARM

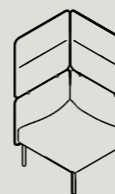

AHC1-S-R/L*#^
W 730 D 730 H 1350 S 440

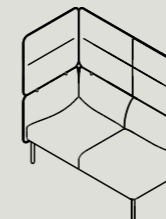

AHA2-R/L*#^
W 1410 D 730 H 1350 S 440

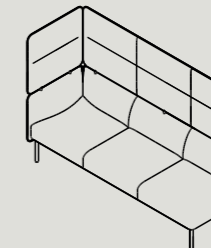

AHA3-S-R/L*#
W 2090 D 730 H 1350 S 440

LOUNGE

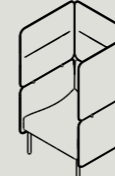

AHL1-S
W 825 D 730 H 1350 S 440



AHL2-S
W 1460 D 730 H 1350 S 440

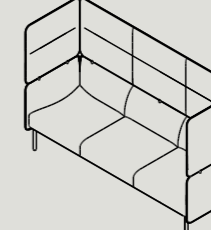

AHL3-S
W 2140 D 730 H 1350 S 440

*R or L refers to Right or Left arm location. Arm location is defined while sitting on lounge.
#High-Back modules should be supported from both ends, achieved through joining to other modules in an 'L' or linear configuration. Alternatively, angled rear legs will need to be used
Dimensions shown in millimetres (mm) and are indicative. For projects requiring specific dimensions, please get in contact.

ADAPT HIGH-BACK (DOUBLE SCREEN) LOUNGE

WITH BACK

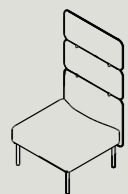

AHB1-D*
W 725 D 730 H 1350 S 440



AHB2-D*
W 1360 D 730 H 1350 S 440



AMB3-D*
W 2040 D 730 H 1350 S 440

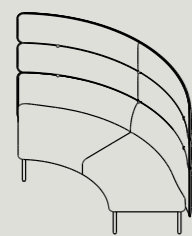

AHB90-D
W 1530 D 1530 H 1350
S 440 IR 800

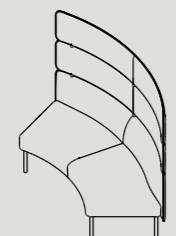

AHB60-D
W 1660 D 1315 H 1350
S 440 IR 1200

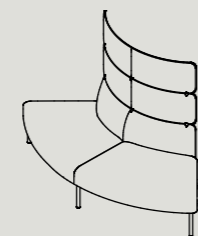

AHB90-R-D
W 1480 D 1480 H 1350
S 440 IR 800

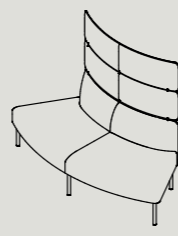

AB60-R-D
W 1610 D 1285 H 1315
S 440 IR 1200

CORNER / WITH SINGLE ARM

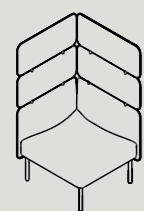

AHC1-D-R/L**^
W 730 D 730 H 1350 S 440



AHA2-D-R/L**^
W 1410 D 730 H 1350 S 440

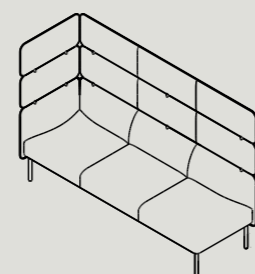

AHA3-D-R/L**^
W 2090 D 730 H 1350 S 440

LOUNGE

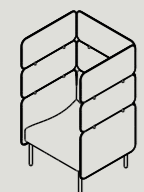

AHL1-D
W 825 D 730 H 1350 S 440

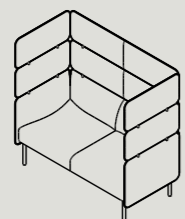

AHL2-D
W 1460 D 730 H 1350 S 440

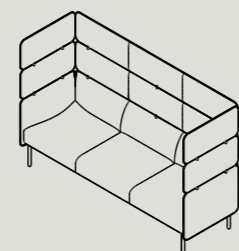

AHL3-D
W 2140 D 730 H 1350 S 440

REAR DESK

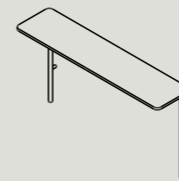

AD2-720
W 1360 D 325 H 720



AD2-900
W 1360 D 325 H 900

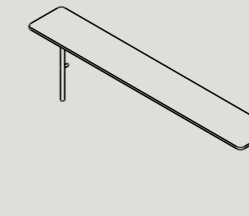

AD3-720
W 2040 D 325 H 720

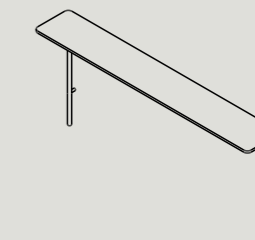

AD3-900
W 2040 D 325 H 900



AD90-720
W 2550 D 750 H 720



AD90-900
W 2550 D 750 H 900

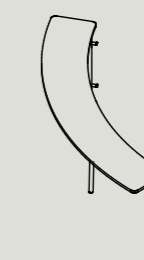

AD60-720
W 2200 D 570 H 720

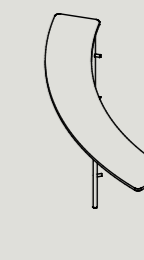

AD60-900
W 2200 D 570 H 900

SIDE TABLE

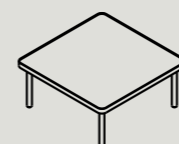

MOVABLE TABLE
AT-310-A
W 675 D 675 H 310

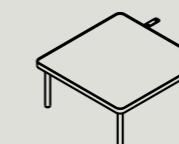

END TABLE
AT-310-B
W 675 D 675 H 310

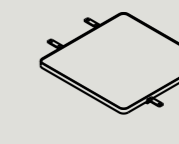

SUSPENDED TABLE
AT-310-C
W 675 D 675 H 310

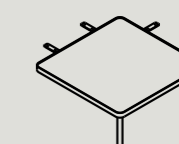

CORNER TABLE
AT-310-D
W 675 D 675 H 310

*R or L refers to Right or Left arm location. Arm location is defined while sitting on lounge.
#High-Back modules should be supported from both ends, achieved through joining to other modules in an 'L' or linear configuration. Alternatively, angled rear legs will need to be used
Dimensions shown in millimetres (mm) and are indicative. For projects requiring specific dimensions, please get in contact.

ACCESSORIES

UNIVERSAL/PIVOTING TABLE



UNIVERSAL TABLE

AT-450
W 450 D 450 H 650



PIVOTING TABLE

AT-350
W 350 D 350 H 480

ROUND OTTOMAN



ROUND OTTOMAN Ø500

AR-500
W 500 D 500 H 450

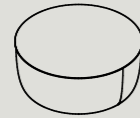

ROUND OTTOMAN Ø900

AR-900
W 900 D 900 H 410

OPTIONAL COMPONENTS



JOINING LEG

AJL
W 278 D 115 H 255



STABILITY LEG

ASTL
W 115 D 115 H 255



SUPPORT LEG

ASUL
W 90 D 64 H 255



FIXED LEG

AFL
W 115 D 115 H 255

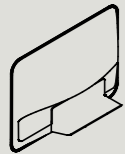

ARM/SINGLE BACKREST

ABA[^]
W 140 D 680 H 500

[^]Used with Adapt Ottomans to create single backrests
Dimensions shown in millimetres (mm) and are indicative. For projects requiring specific dimensions, please get in contact.

TECHNICAL ⁰⁸

AVAILABLE FINISHES

LOUNGE

CUSTOM
UPHOLSTERYCUSTOM
LEATHERBLACK
POWDER COAT
LEG/DETAILSWHITE
POWDER COAT
LEG/DETAILS

DESK / TOP & LEGS

BLACK
LAMINATE
TOPWHITE
LAMINATE
TOPBLACK
POWDER COAT
LEGWHITE
POWDER COAT
LEG

SIDE TABLE / TOP & LEG

BLACK
LAMINATE
TOPBLACK
MIRROR
TOPBLACK
POWDER COAT
LEG/FRAMEWHITE
POWDER COAT
LEG/FRAME

UNIVERSAL & PIVOTING TABLE

BLACK
POWDER
COATED MDF /
STEEL

MATERIALS & POWER

LOUNGE

INTERNAL FRAME / The internal frame is constructed from kiln-dried hardwood and plywood. The seat utilises metal springs for support, creating a high level of comfort and ensuring long-term endurance.

BACK & ARM / The back and arms are constructed from plywood (lounger) or tubular steel and plywood (mid-back lounge/high-back lounge/curved modules). Each back and arm has a unique attachment bracket located under the lounge making the changing of components as simple as removing four bolts.

SEAT CUSHION AND UPHOLSTERY / Formed from shaped polyurethane foam of different densities and polyethylene terephthalate (PET) to create a supportive yet comfortable seat. Upholstery and leathers are available in a range of varying textures, durability and tactility properties. Upholstery is selected at the time of ordering.

LEGS, NODES AND DETAILS / Made from tubular powder coated steel, steel plate and plastic feet for leg inserts.

DESK

DESK TOP / Available in 18mm laminate with custom materials available upon request (see Finishes above). Each rear mounted desk requires two or three rear legs to support the desk top and a central support bracket which sits under the centre of the desk (on three seater straight modules). The smaller rear legs of the lounge are then removed as the entire lounge is supported by the desk legs.

DESK LEGS AND BRACKET / Constructed from tubular powder coated steel, powder coated steel plate and plastic feet for leg inserts.

SIDE TABLE

TABLE TOP / Available in laminate and black mirror as a standard with custom finishes including timber veneer available upon request (see Finishes above). The table is available in multiple configurations (see following pages) and can be easily attached to any lounge via use of the simple Adapt connectors which bolt into the underside of the lounge - or with four legs for a movable table.

LEGS AND EDGE / Manufactured from tubular powder coated steel, powder coated steel bar and plastic feet for leg inserts.

UNIVERSAL/PIVOTING TABLE

TABLE TOP / Available in black powder coated MDF with other materials available upon request.

TABLE BASE / Constructed from tubular powder coated steel and powder coated sheet with a felt bottom (Universal Table).

POWER INTEGRATION

Various integrated power solutions are available within the Adapt collection. A power / USB module can be located to the underside of any of the lounge or ottoman options. This allows simple plug and play within the internal of any of the lounge settings.

A built in power / USB module can be located directly into the rear of any back. This offers an ideal location to power up while using the rear desks (see following pages).

ENVIRONMENTAL

The Adapt lounges are in the process of becoming GECA certified.





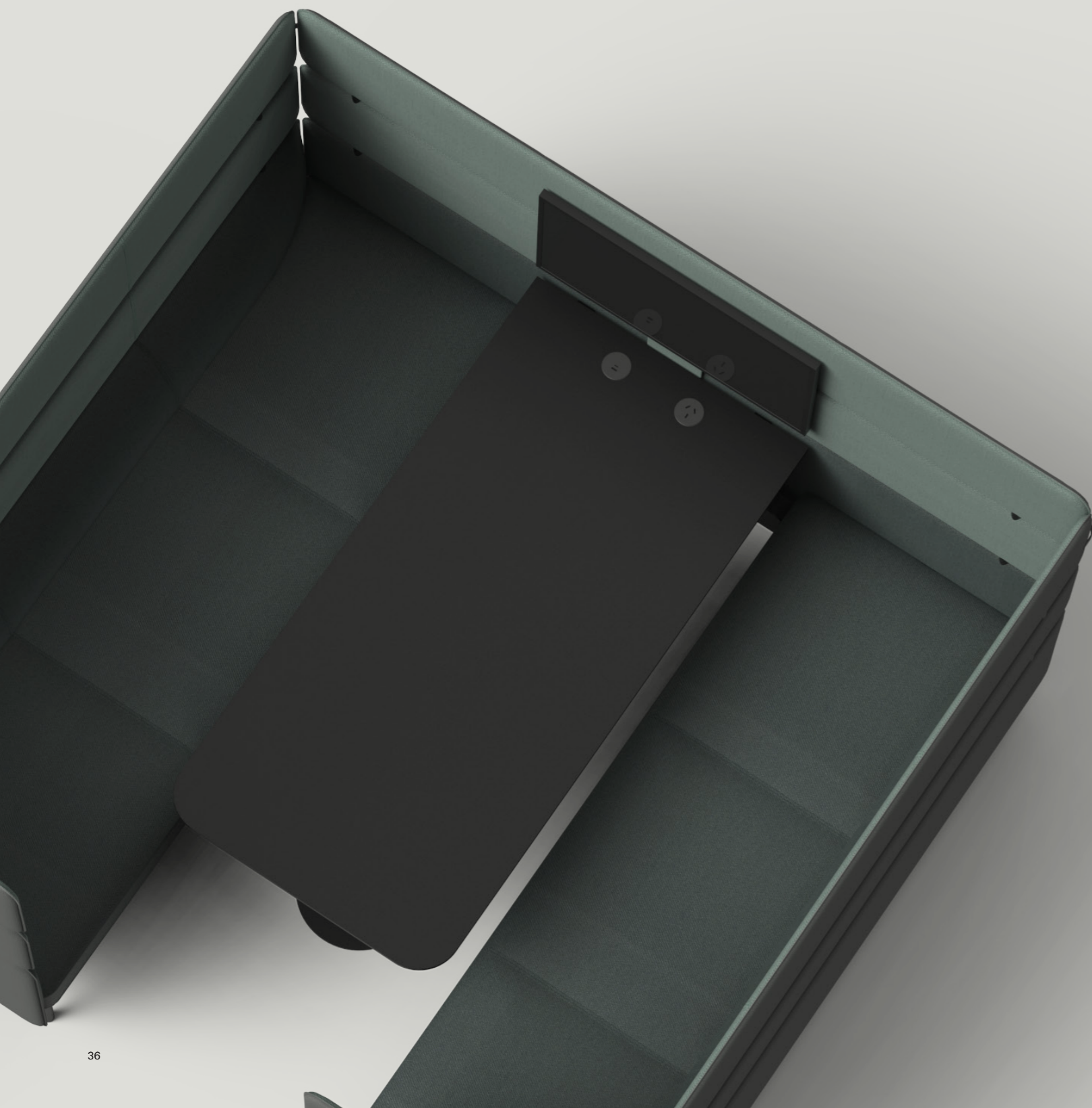
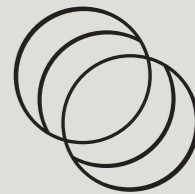

Designed with the same clean lines and soft surfaces of the *Adapt Lounge*, the *Adapt Hub* creates spaces for meetings, work collaboration and private areas for focused work.

As a stand alone unit, the Adapt Hub can be placed in existing spaces without need for built partitions or screens, allowing seamless integration into interiors and to the changing requirements of the space.



A modular system with functionality at its core, Adapt Hub caters for offices, universities, airports and hospitality spaces. Conceived for both small and large open-plan spaces, the Hub is available from small 2 seater private study booths to large 6 seater presentation and collaboration spaces as well as in various heights, widths, table options and with optional accessories.

EXAMPLE CONFIGURATIONS ⁰¹

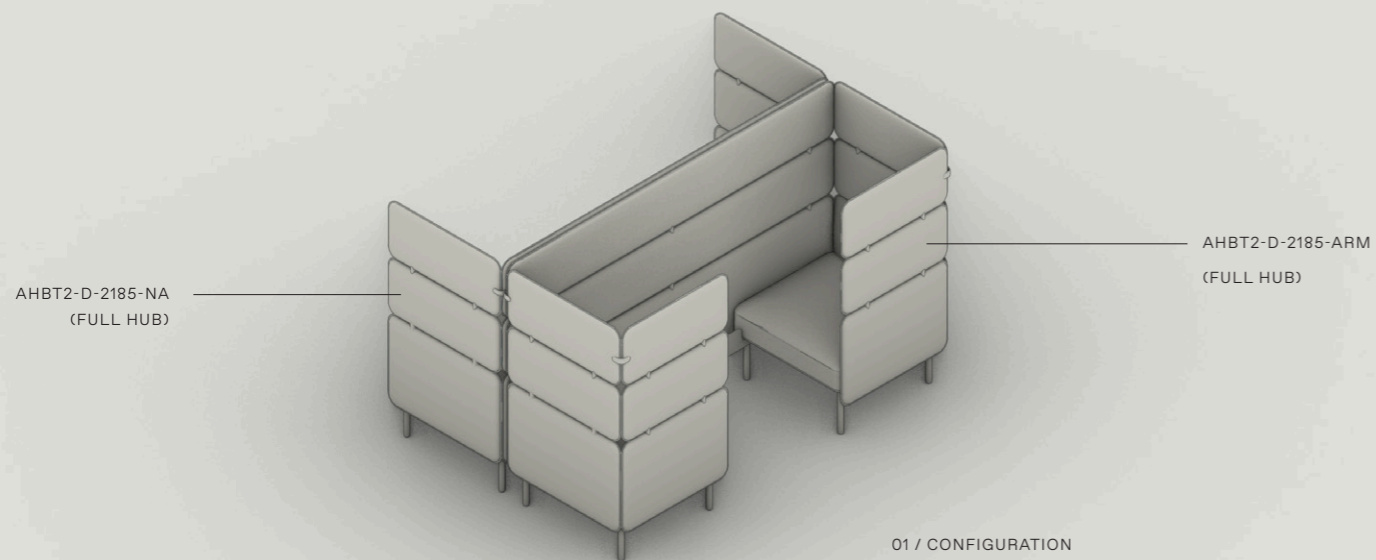

01 / CONFIGURATION
TWO SEATER HUBS SITTING BACK TO BACK IN HIGH-BACK FORM

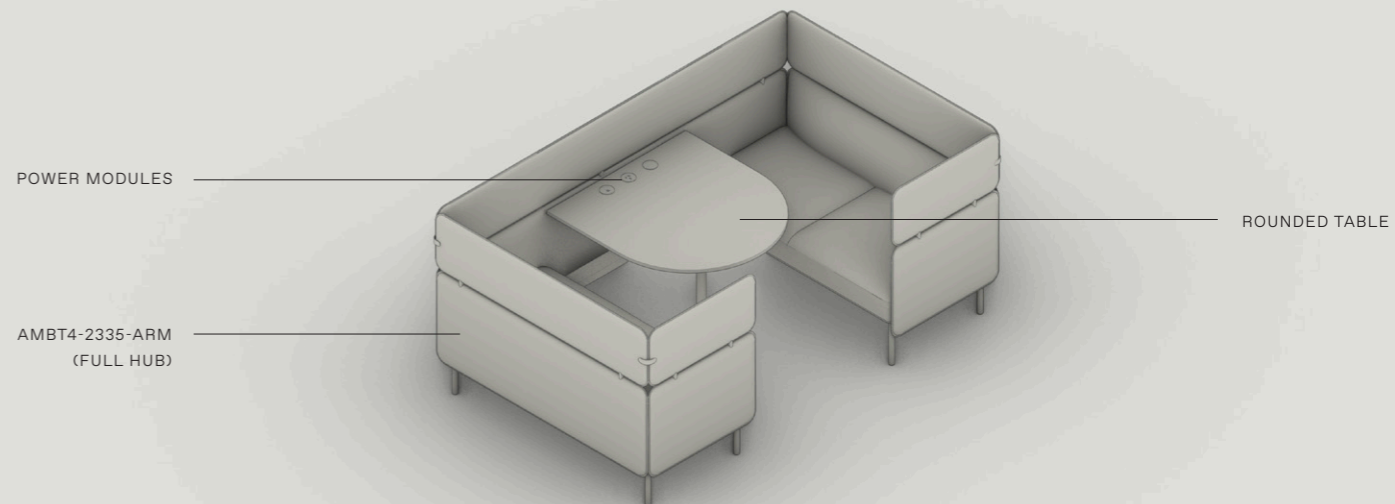

03 / CONFIGURATION
WIDER FOUR SEATER HUB WITH ROUND TABLE IN MID-BACK FORM WITH ARMS FOR ADDITIONAL PRIVACY

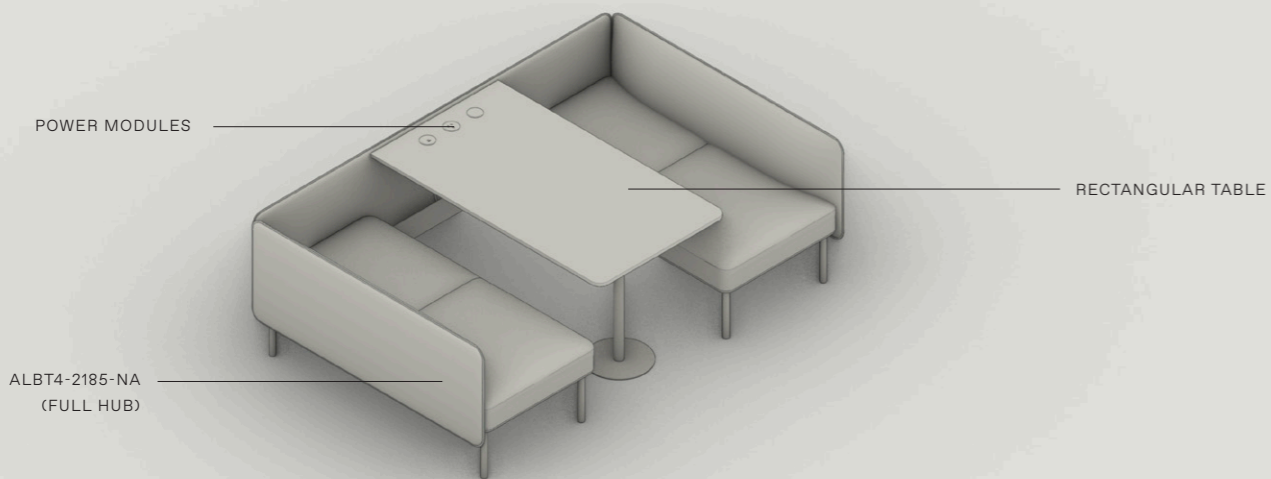

02 / CONFIGURATION
FOUR SEATER LOW-BACK HUB WITH CENTRAL TABLE AND IN-DESK POWER MODULES

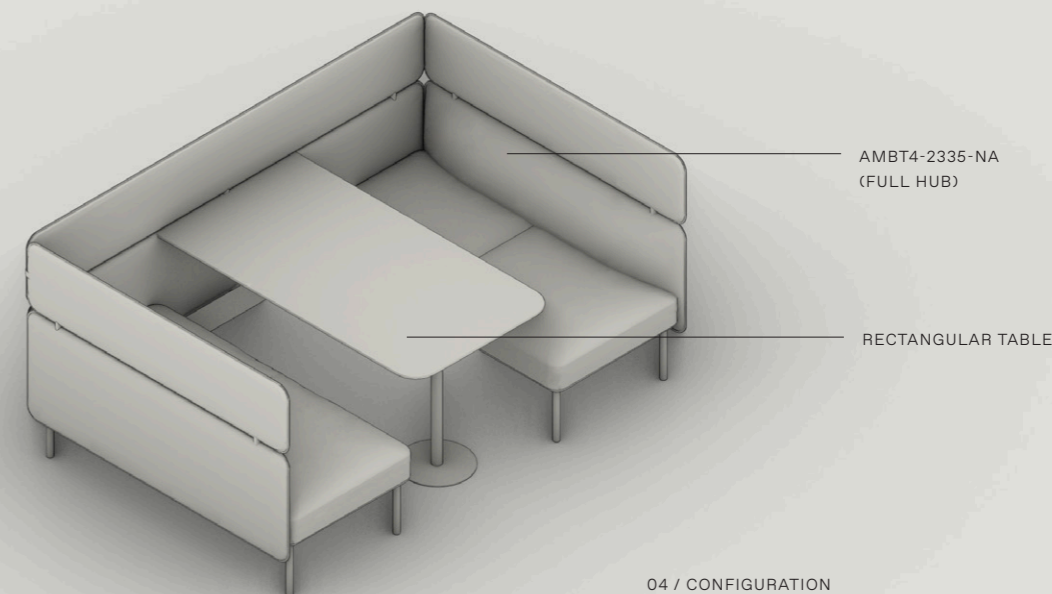

04 / CONFIGURATION
WIDER FOUR SEATER HUB WITH RECTANGULAR TABLE IN MID-BACK FORM WITHOUT ARMS PROVIDES EASIER INGRESS/EGRESS AND A LARGER TABLE

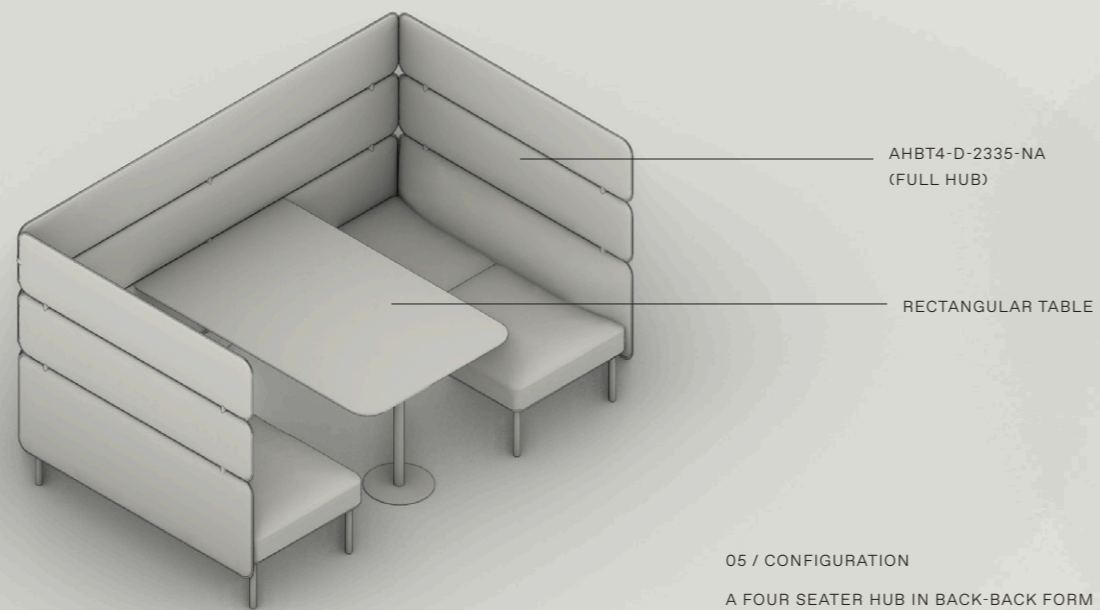

05 / CONFIGURATION
 A FOUR SEATER HUB IN BACK-BACK FORM WITHOUT ARMS PROVIDES A MORE PRIVATE SPACE FOR MEETINGS

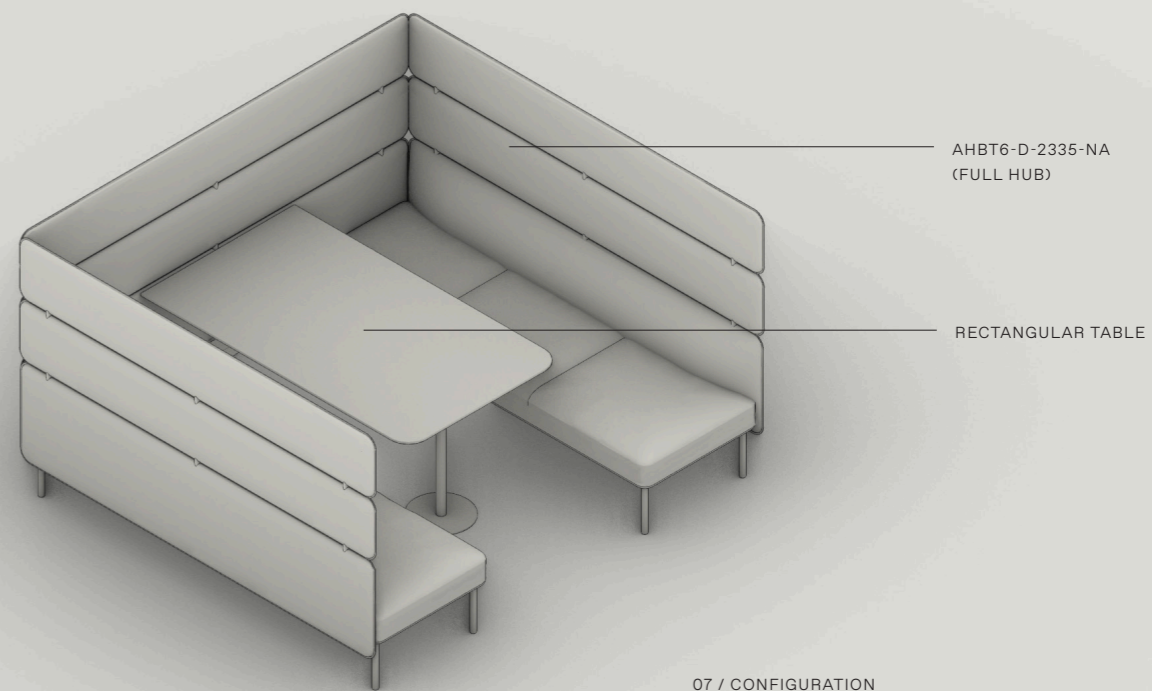

07 / CONFIGURATION
 HIGH-BACK HUB WITHOUT ARMS TO PROVIDE A SPACE FOR LARGER MEETINGS

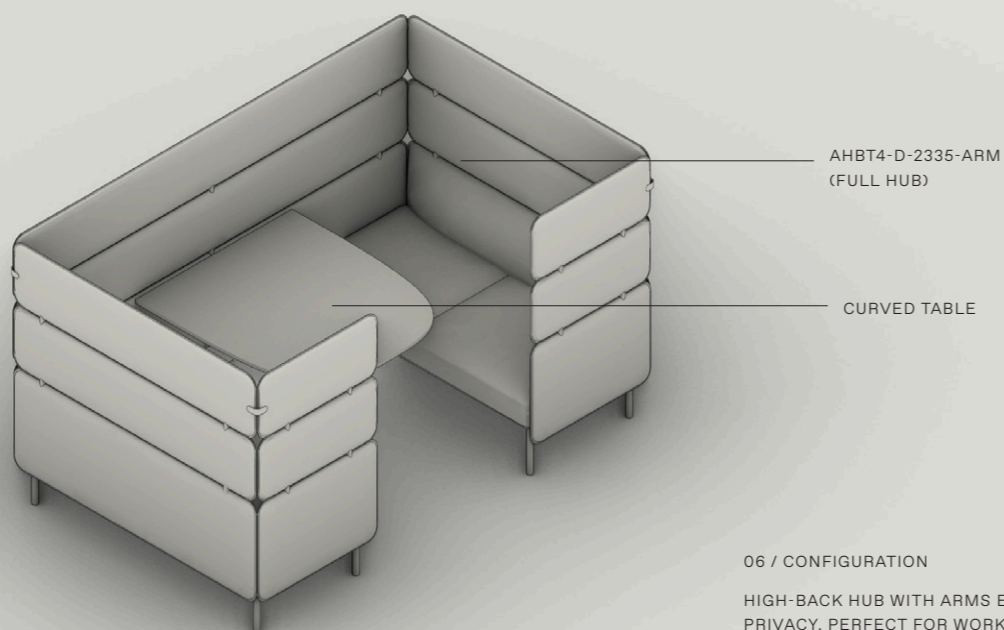

06 / CONFIGURATION
 HIGH-BACK HUB WITH ARMS ENABLES EVEN MORE PRIVACY, PERFECT FOR WORKING AND SMALL PRIVATE MEETINGS

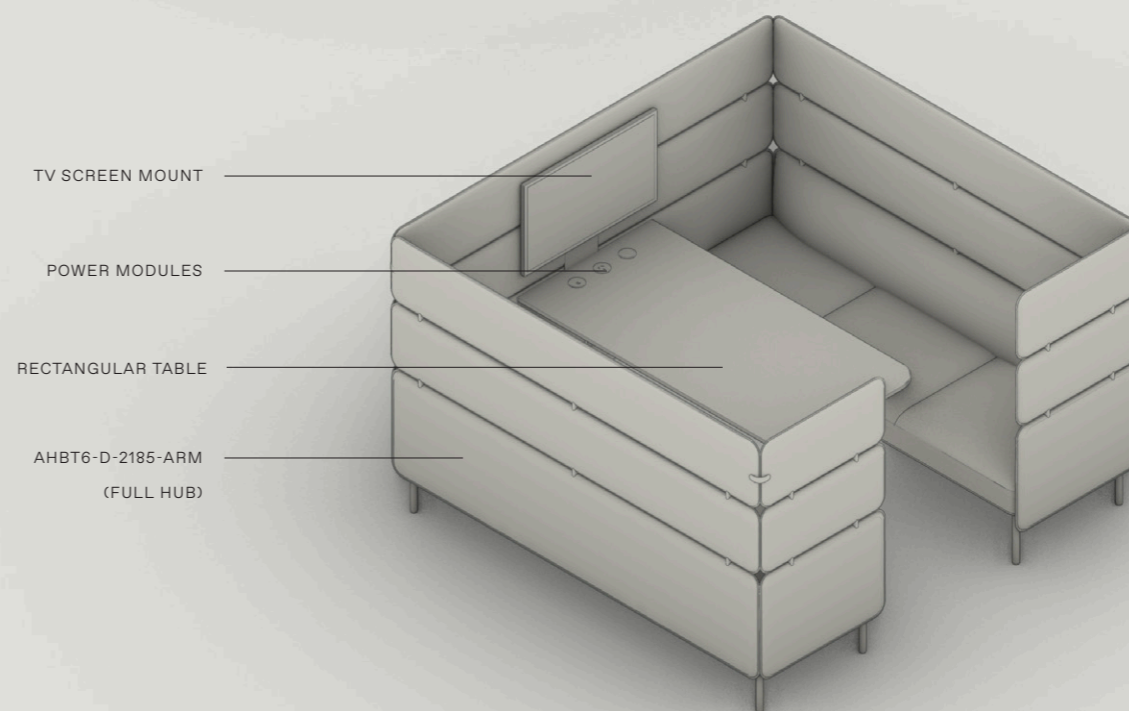

08 / CONFIGURATION
 THE ADDITION OF A TV SCREEN AND IN-DESK POWER MODULES HELP ENABLE SEAMLESS MEETINGS

DETAILS 02

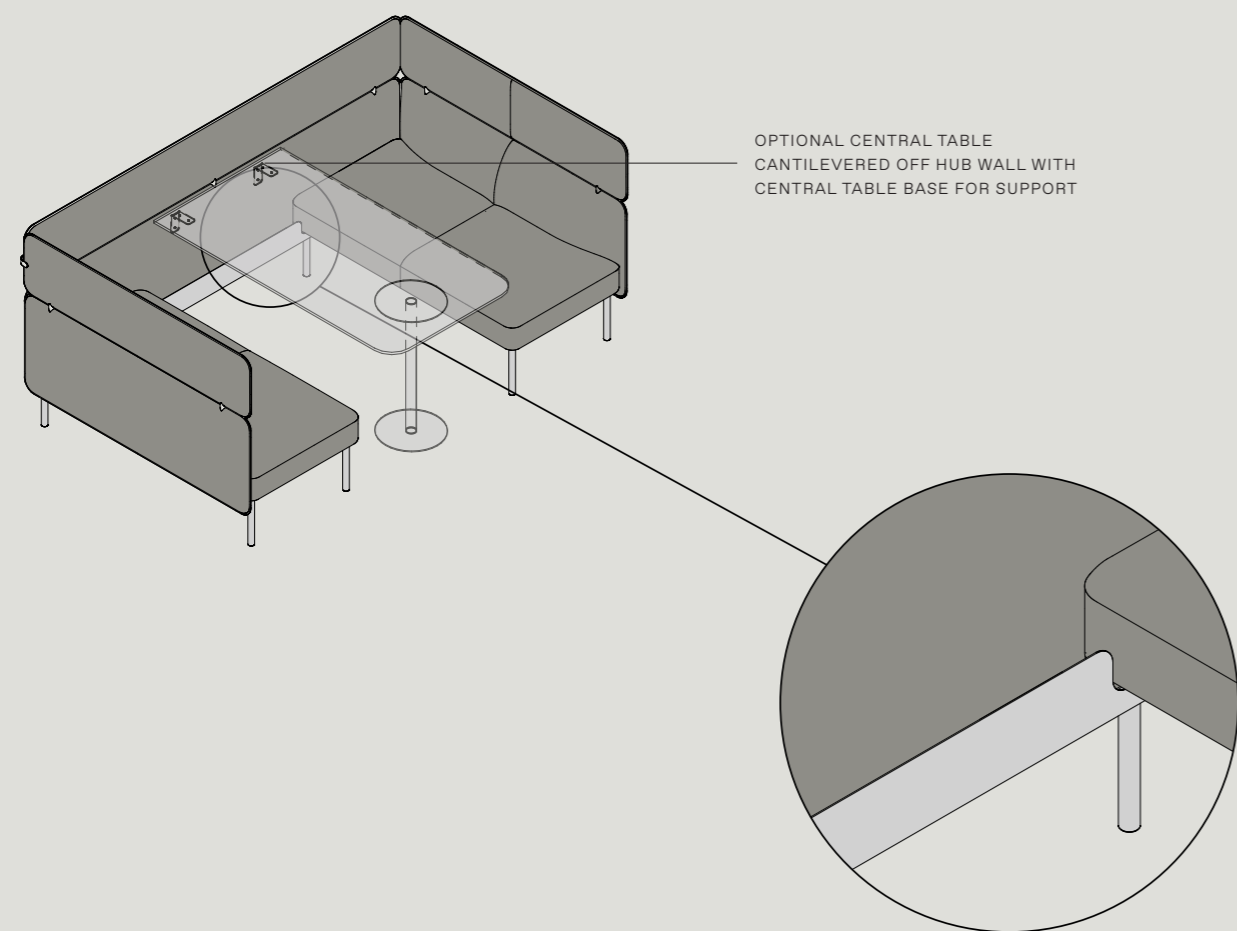

OPTIONAL CENTRAL TABLE
CANTILEVERED OFF HUB WALL WITH
CENTRAL TABLE BASE FOR SUPPORT

A small shelf runs between both lounges, providing a space to store stationery, magazines and other office supplies.

POWER 03

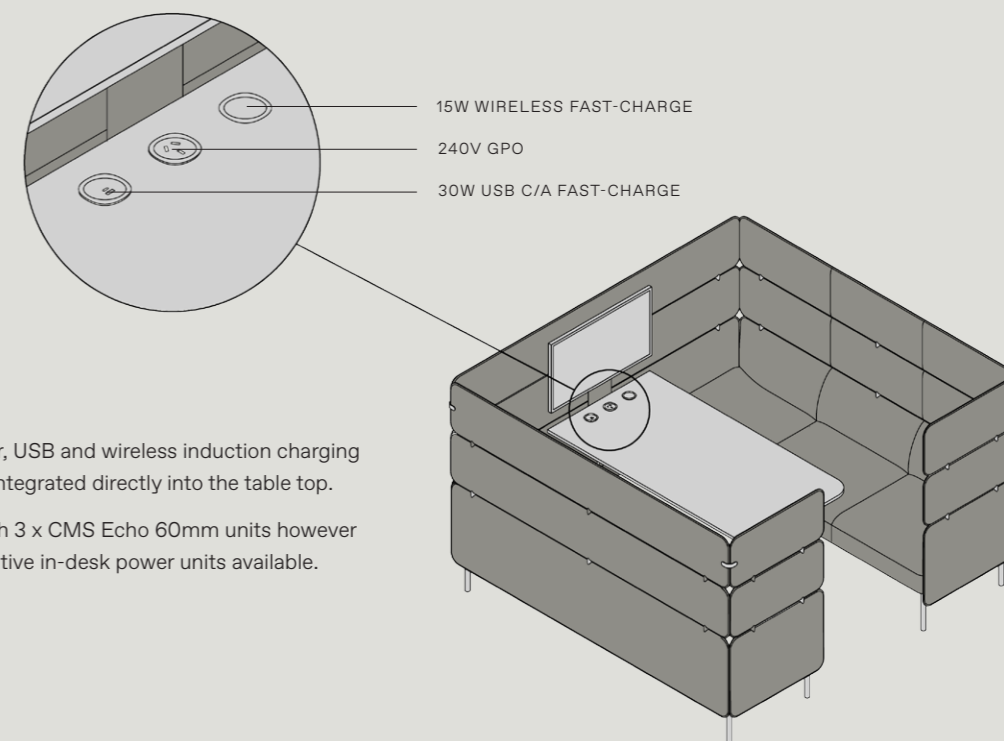

15W WIRELESS FAST-CHARGE
240V GPO
30W USB C/A FAST-CHARGE

GPO Power, USB and wireless induction charging can be integrated directly into the table top.

Shown with 3 x CMS Echo 60mm units however alternative in-desk power units available.

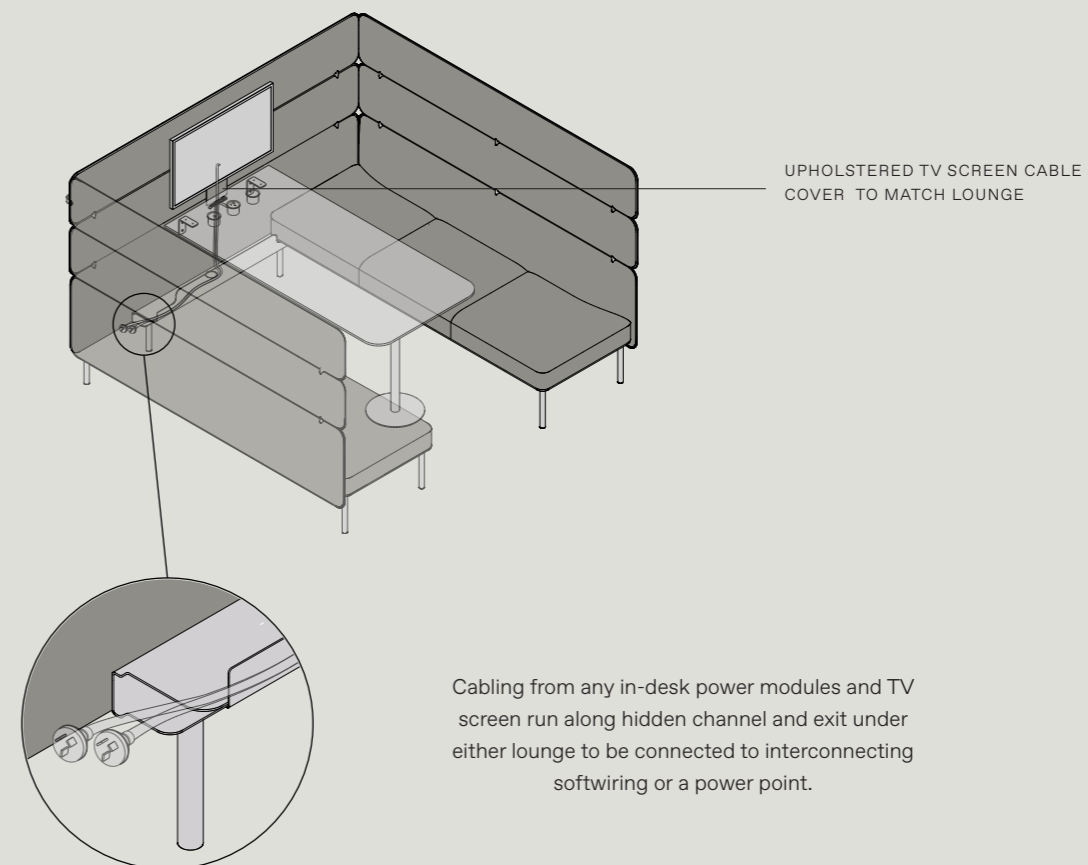

UPHOLSTERED TV SCREEN CABLE COVER TO MATCH LOUNGE

Cabling from any in-desk power modules and TV screen run along hidden channel and exit under either lounge to be connected to interconnecting softwiring or a power point.

SPECIFICATIONS 04

1. SELECT SEATING REQUIREMENTS

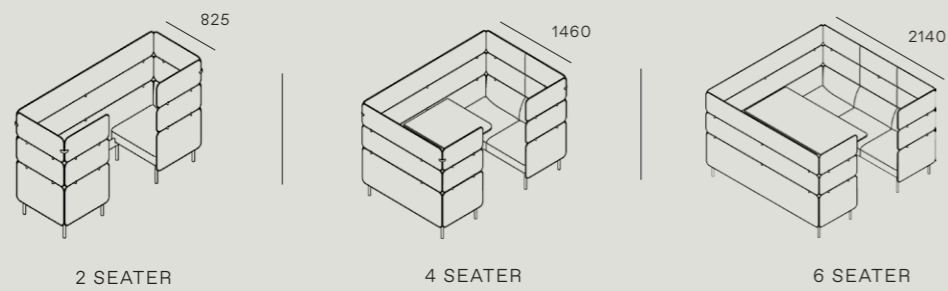

2. SELECT WIDTH

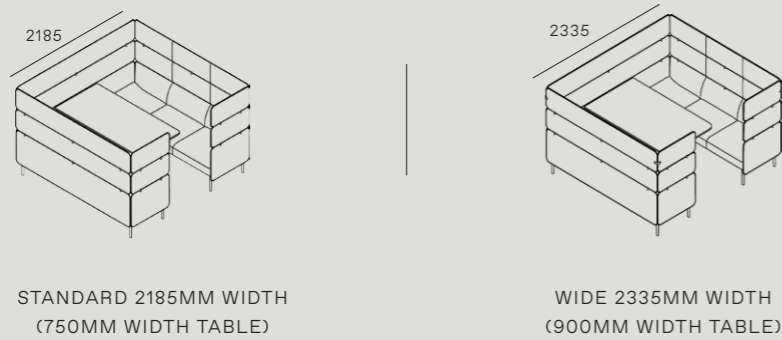

3. SELECT HEIGHT

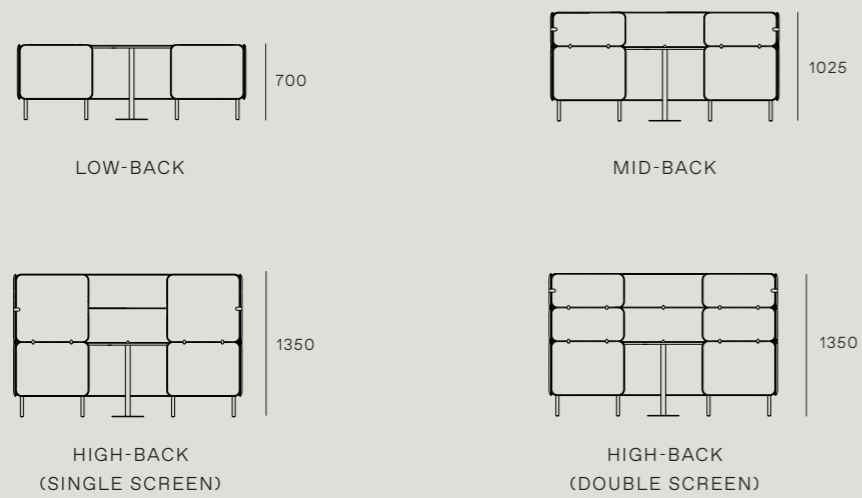

4. SELECT WITH OR WITHOUT ARMS

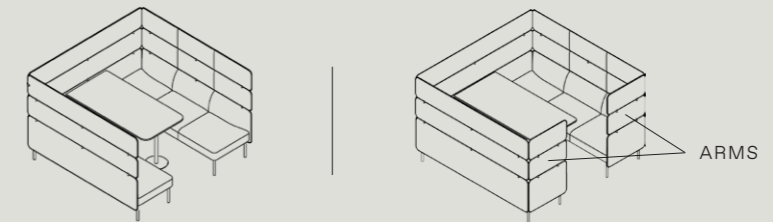

5. SELECT TABLE STYLE (IF REQUIRED)*

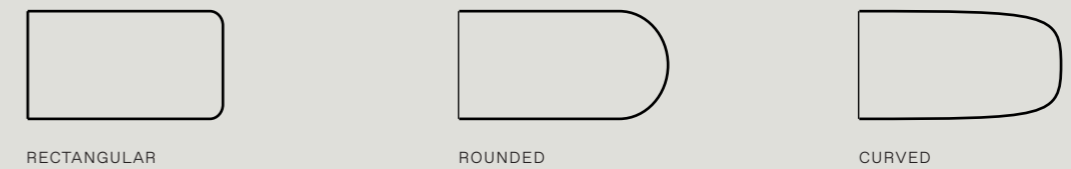

6. ADDITIONAL HUB OPTIONS

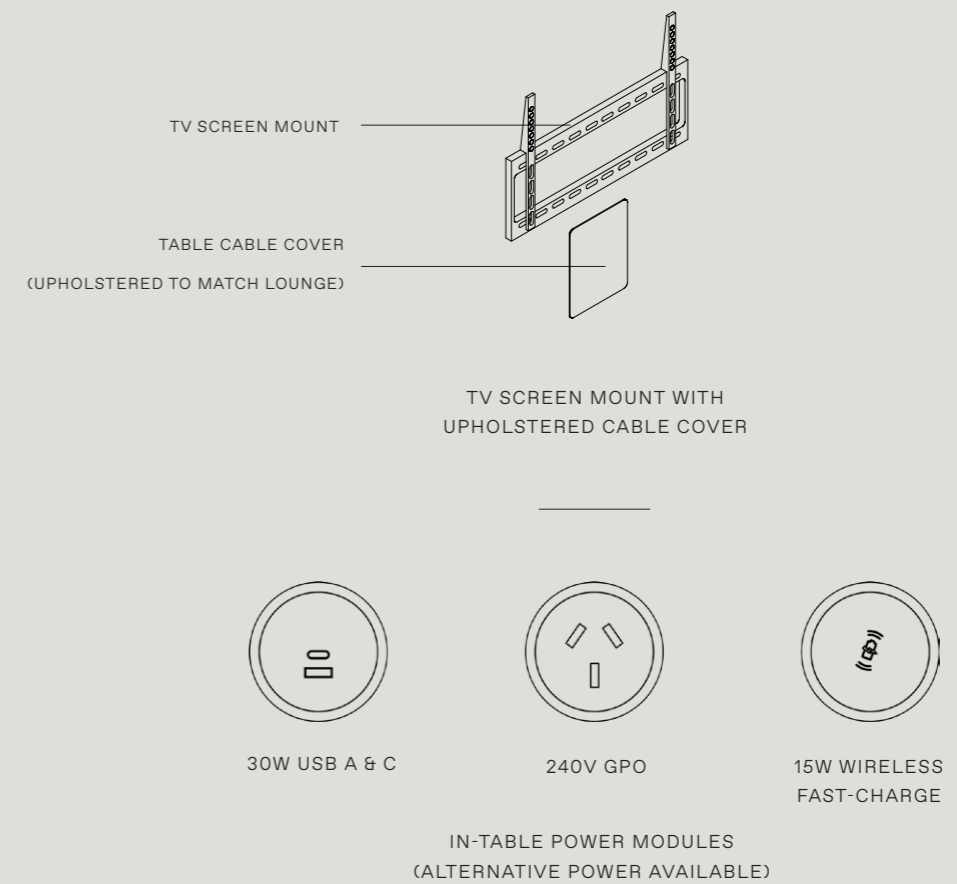

*Table dimensions based on specific Hub selected

2 SEATER LOW-BACK

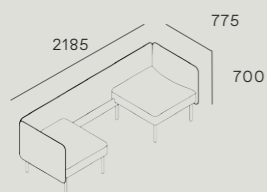

2 SEATER LOW-BACK
2185MM W/O ARMS

ALBT2-2150-NA
W 2185 / D 775
H 700 / S 440

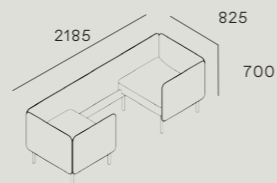

2 SEATER LOW-BACK
2185MM W/ ARMS

ALBT2-2150-ARM
W 2185 / D 825
H 700 / S 440

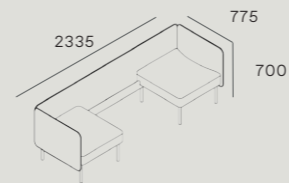

2 SEATER LOW-BACK
2335MM W/O ARMS

ALBT2-2335-NA
W 2335 / D 775
H 700 / S 440

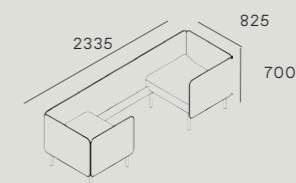

2 SEATER LOW-BACK
2335MM W/ ARMS

ALBT2-2335-ARM
W 2335 / D 825
H 700 / S 440

4 SEATER LOW-BACK

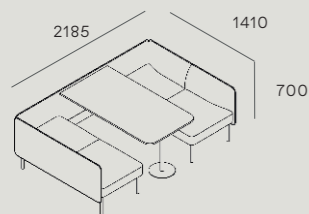

4 SEATER LOW-BACK
2185MM W/O ARMS

ALBT4-2150-NA
W 2185 / D 1410
H 700 / S 440

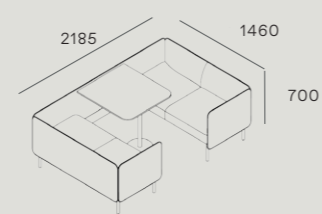

4 SEATER LOW-BACK
2185MM W/ ARMS

ALBT4-2150-ARM
W 2185 / D 1460
H 700 / S 440

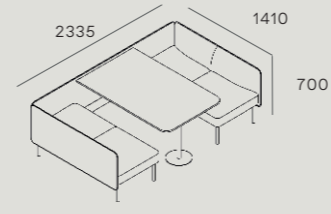

4 SEATER LOW-BACK
2335MM W/O ARMS

ALBT4-2335-NA
W 2335 / D 1410
H 700 / S 440

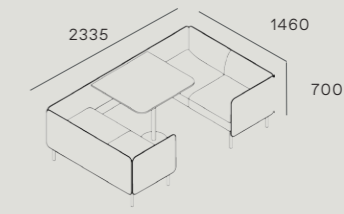

4 SEATER LOW-BACK
2335MM W/ ARMS

ALBT4-2335-ARM
W 2335 / D 1460
H 700 / S 440

6 SEATER LOW-BACK

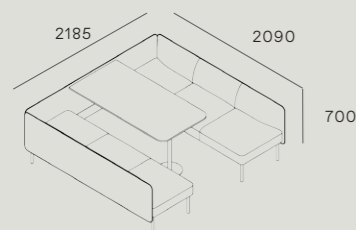

6 SEATER LOW-BACK
2185MM W/O ARMS

ALBT6-2150-NA
W 2185 / D 2090
H 700 / S 440

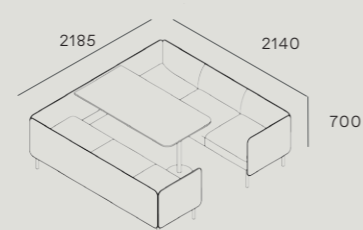

6 SEATER LOW-BACK
2185MM W/ ARMS

ALBT6-2150-ARM
W 2185 / D 2140
H 700 / S 440

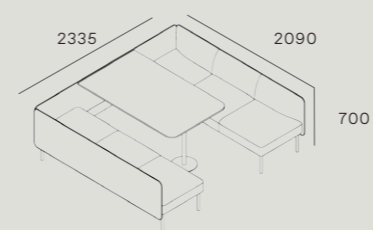

6 SEATER LOW-BACK
2335MM W/O ARMS

ALBT6-2335-NA
W 2335 / D 2090
H 700 / S 440

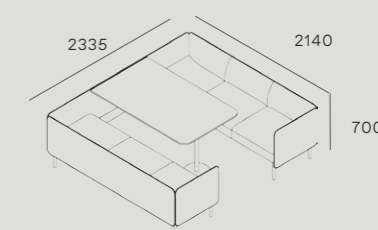

6 SEATER LOW-BACK
2335MM W/ ARMS

ALBT6-2335-ARM
W 2335 / D 2140
H 700 / S 440

Hub tables ordered separately (where available).

Dimensions shown are indicative. For projects requiring specific dimensions, please get in contact.

2 SEATER MID-BACK

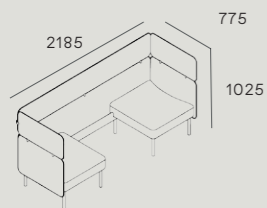

2 SEATER MID-BACK
2185MM W/O ARMS

AMBT2-2185-NA
W 2185 / D 775
H 1025 / S 440

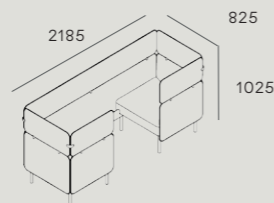

2 SEATER MID-BACK
2185MM W/ ARMS

AMBT2-2185-ARM
W 2185 / D 825
H 1025 / S 440

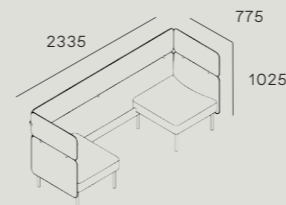

2 SEATER MID-BACK
2335MM W/O ARMS

AMBT2-2335-NA
W 2335 / D 775
H 1025 / S 440

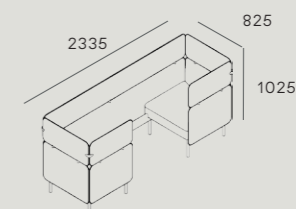

2 SEATER MID-BACK
2335MM W/ ARMS

AMBT2-2335-ARM
W 2335 / D 825
H 1025 / S 440

4 SEATER MID-BACK

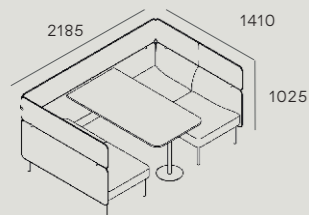

4 SEATER MID-BACK
2185MM W/O ARMS

AMBT4-2185-NA
W 2185 / D 1410
H 1025 / S 440

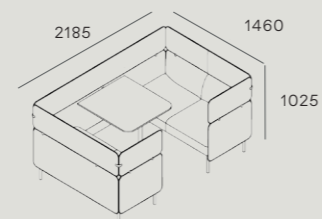

4 SEATER MID-BACK
2185MM W/ ARMS

AMBT4-2185-ARM
W 2185 / D 1460
H 1025 / S 440

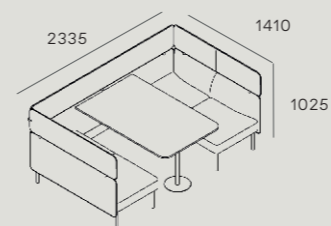

4 SEATER MID-BACK
2335MM W/O ARMS

AMBT4-2335-NA
W 2335 / D 1410
H 1025 / S 440

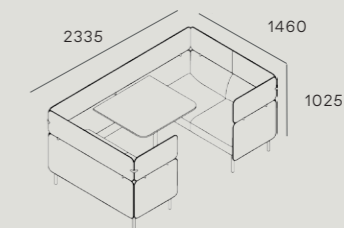

4 SEATER MID-BACK
2335MM W/ ARMS

AMBT4-2335-ARM
W 2335 / D 1460
H 1025 / S 440

6 SEATER MID-BACK

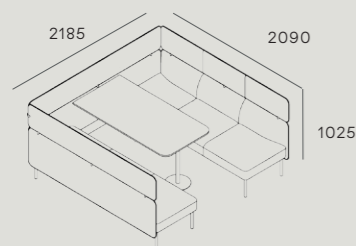

6 SEATER MID-BACK
2185MM W/O ARMS

AMBT6-2185-NA
W 2185 / D 2090
H 1025 / S 440

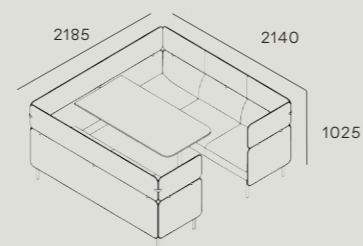

6 SEATER MID-BACK
2185MM W/ ARMS

AMBT6-2185-ARM
W 2185 / D 2140
H 1025 / S 440

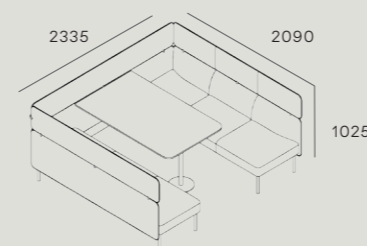

6 SEATER MID-BACK
2335MM W/O ARMS

AMBT6-2335-NA
W 2335 / D 2090
H 1025 / S 440

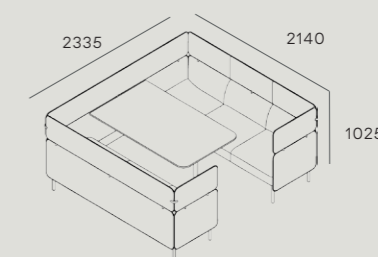

6 SEATER MID-BACK
2335MM W/ ARMS

AMBT6-2335-ARM
W 2335 / D 2140
H 1025 / S 440

Hub tables ordered separately (where available).

Dimensions shown are indicative. For projects requiring specific dimensions, please get in contact.

2 SEATER HIGH-BACK (SINGLE SCREEN)

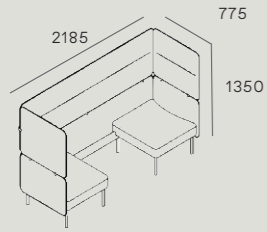

2 SEATER HIGH-BACK
(SINGLE SCREEN)
2185MM W/O ARMS

AHBT2-S-2185-NA
W 2185 / D 775
H 1350 / S 440

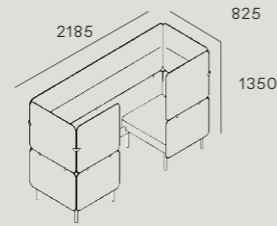

2 SEATER HIGH-BACK
(SINGLE SCREEN)
2185MM W/ ARMS

AHBT2-S-2185-ARM
W 2185 / D 825
H 1350 / S 440

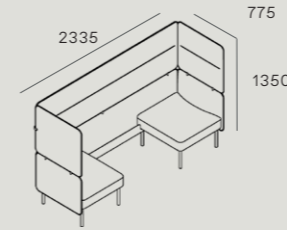

2 SEATER HIGH-BACK
(SINGLE SCREEN)
2335MM W/O ARMS

AHBT2-S-2335-NA
W 2335 / D 775
H 1350 / S 440

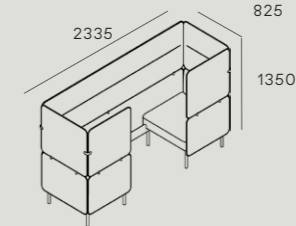

2 SEATER HIGH-BACK
(SINGLE SCREEN)
2335MM W/ ARMS

AHBT2-S-2335-ARM
W 2335 / D 825
H 1350 / S 440

4 SEATER HIGH-BACK (SINGLE SCREEN)

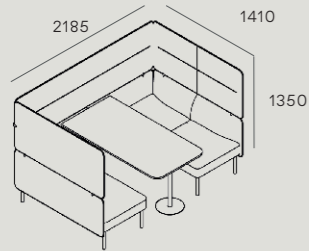

4 SEATER HIGH-BACK
(SINGLE SCREEN)
2185MM W/O ARMS

AHBT4-S-2185-NA
W 2185 / D 1410
H 1350 / S 440

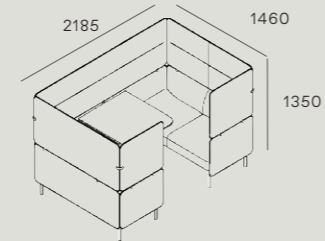

4 SEATER HIGH-BACK
(SINGLE SCREEN)
2185MM W/ ARMS

AHBT4-S-2185-ARM
W 2185 / D 1460
H 1350 / S 440

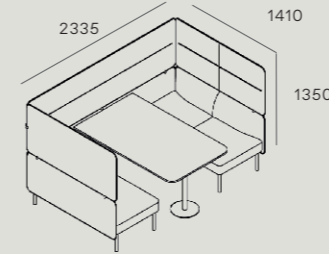

4 SEATER HIGH-BACK
(SINGLE SCREEN)
2335MM W/O ARMS

AHBT4-S-2335-NA
W 2335 / D 1410
H 1350 / S 440

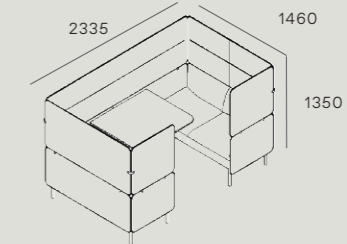

4 SEATER HIGH-BACK
(SINGLE SCREEN)
2335MM W/ ARMS

AHBT4-S-2335-ARM
W 2335 / D 1460
H 1350 / S 440

6 SEATER HIGH-BACK (SINGLE SCREEN)

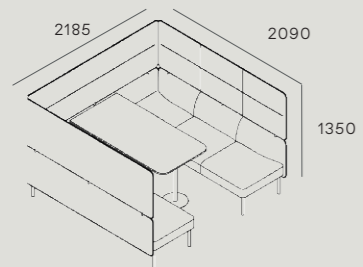

6 SEATER HIGH-BACK
(SINGLE SCREEN)
2185MM W/O ARMS

AHBT6-S-2185-NA
W 2185 / D 2090
H 1350 / S 440

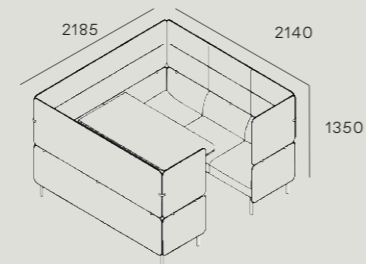

6 SEATER HIGH-BACK
(SINGLE SCREEN)
2185MM W/ ARMS

AHBT6-S-2185-ARM
W 2185 / D 2140
H 1350 / S 440

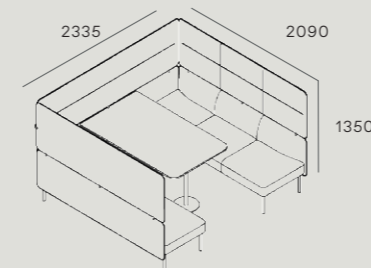

6 SEATER HIGH-BACK
(SINGLE SCREEN)
2335MM W/O ARMS

AHBT6-S-2335-NA
W 2335 / D 2090
H 1350 / S 440

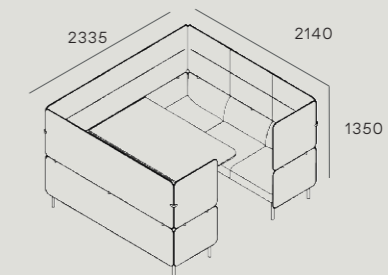

6 SEATER HIGH-BACK
(SINGLE SCREEN)
2335MM W/ ARMS

AHBT6-S-2335-ARM
W 2335 / D 2140
H 1350 / S 440

Hub tables ordered separately (where available).

Dimensions shown are indicative. For projects requiring specific dimensions, please get in contact.

2 SEATER HIGH-BACK (SINGLE SCREEN)

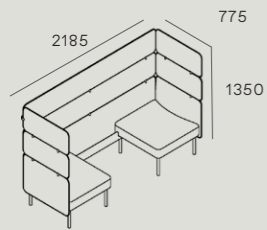

2 SEATER HIGH-BACK
(DOUBLE SCREEN)
2185MM W/O ARMS

AHBT2-D-2185-NA
W 2185 / D 775
H 1350 / S 440

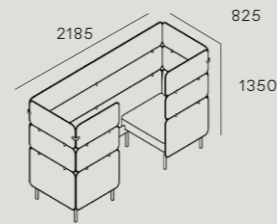

2 SEATER HIGH-BACK
(DOUBLE SCREEN)
2185MM W/ ARMS

AHBT2-D-2185-ARM
W 2185 / D 825
H 1350 / S 440

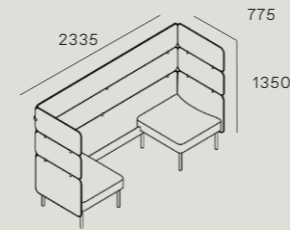

2 SEATER HIGH-BACK
(DOUBLE SCREEN)
2335MM W/O ARMS

AHBT2-D-2335-NA
W 2335 / D 775
H 1350 / S 440

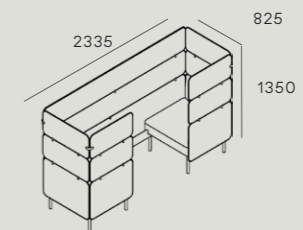

2 SEATER HIGH-BACK
(DOUBLE SCREEN)
2335MM W/ ARMS

AHBT2-D-2335-ARM
W 2335 / D 825
H 1350 / S 440

4 SEATER HIGH-BACK (SINGLE SCREEN)

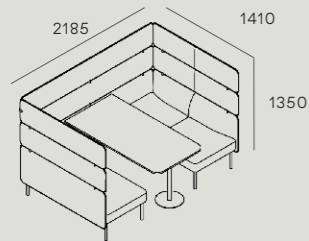

4 SEATER HIGH-BACK
(DOUBLE SCREEN)
2185MM W/O ARMS

AHBT4-D-2185-NA
W 2185 / D 1410
H 1350 / S 440

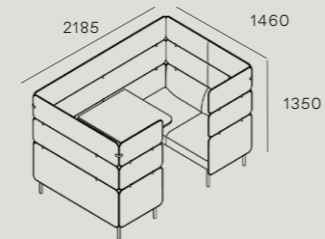

4 SEATER HIGH-BACK
(DOUBLE SCREEN)
2185MM W/ ARMS

AHBT4-D-2185-ARM
W 2185 / D 1460
H 1350 / S 440

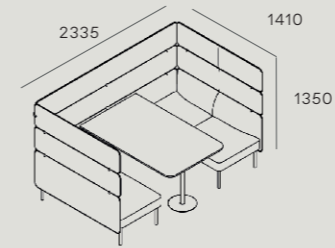

4 SEATER HIGH-BACK
(DOUBLE SCREEN)
2335MM W/O ARMS

AHBT4-D-2335-NA
W 2335 / D 1410
H 1350 / S 440

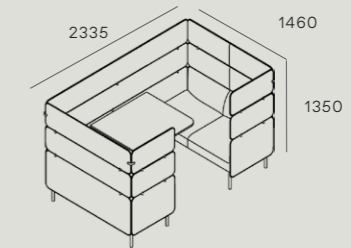

4 SEATER HIGH-BACK
(DOUBLE SCREEN)
2335MM W/ ARMS

AHBT4-D-2335-ARM
W 2335 / D 1460
H 1350 / S 440

6 SEATER HIGH-BACK (SINGLE SCREEN)

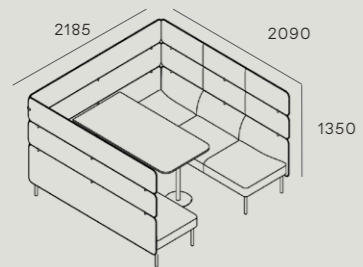

6 SEATER HIGH-BACK
(DOUBLE SCREEN)
2185MM W/O ARMS

AHBT6-D-2185-NA
W 2185 / D 2090
H 1350 / S 440

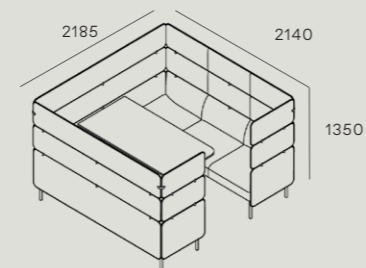

6 SEATER HIGH-BACK
(DOUBLE SCREEN)
2185MM W/ ARMS

AHBT6-D-2185-ARM
W 2185 / D 2140
H 1350 / S 440

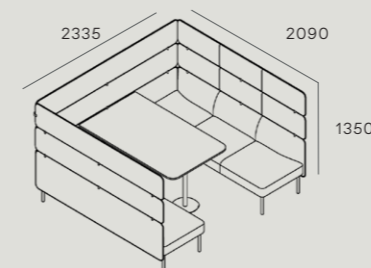

6 SEATER HIGH-BACK
(DOUBLE SCREEN)
2335MM W/O ARMS

AHBT6-D-2335-NA
W 2335 / D 2090
H 1350 / S 440

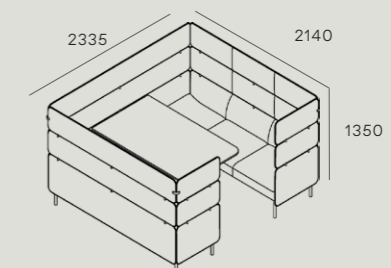

6 SEATER HIGH-BACK
(DOUBLE SCREEN)
2335MM W/ ARMS

AHBT6-D-2335-ARM
W 2335 / D 2140
H 1350 / S 440

Hub tables ordered separately (where available).

Dimensions shown are indicative. For projects requiring specific dimensions, please get in contact.



PHOTOGRAPHY BY HAYDN CATTACH - HAYDNCATTACH.COM & MR.P STUDIOS - MRPSTUDIOS.COM
COLOUR AND SWATCHES SHOWN IN THIS DOCUMENT ARE FOR REFERENCE ONLY AND MAY DIFFER IN ACTUALITY.
COPYRIGHT ©2020 ROSS GARDAM PTY LTD. ALL CONCEPTS, PHOTOGRAPHY AND IDEAS CONTAINED WITHIN THIS DOCUMENT
ARE PRIVATE AND CONFIDENTIAL. THEY MUST NOT BE REPRODUCED IN ANY WAY OR FORM AND REMAIN THE INTELLECTUAL
PROPERTY OF ROSS GARDAM. ALL PRODUCTS ARE REGISTERED DESIGNS WITH IP AUSTRALIA.