



KYOTO



KYOTO 2013

Sideboard in solid wood and blockboard, available in two different versions having different frame thickness. Drawers assembled with dovetail joints and solid wood plinth to raise the unit from the ground.

STANDARD COMPOSITION: 2 DOORS - 2 ADJUSTABLE SHELVES - 4 DRAWERS

ADDITIONAL ACCESSORIES: SEE TECHNICAL NOTES

STANDARD VERSION: GROOVED HANDLES; DRAWERS ON METAL RUNNERS

PIECES OF FURNITURE				
CODE	SIZE	A1	A2	A3
KYOTO 2013	W.220 x D.50 x H.77	■	■	■
KYOTO	W.220 x D.50 x H.80	■	■	■

AVAILABLE FINISHES:

A1: walnut without knots, walnut with knots, elm

A2: oak without knots, oak with knots, cherry, maple

A3: oak without knots finish: whitened, mystic black, neutro
oak with knots finish: whitened, mystic black, neutro

KYOTO - KYOTO 2013

KYOTO

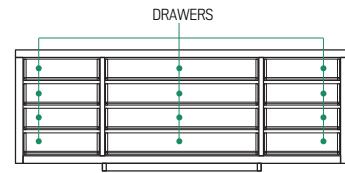
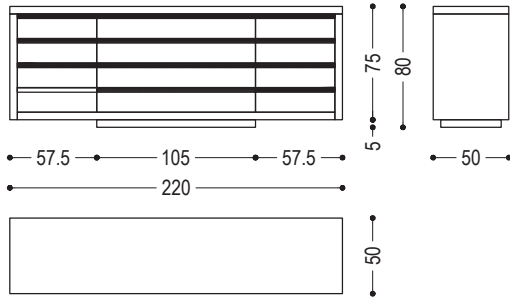

KYOTO 2013

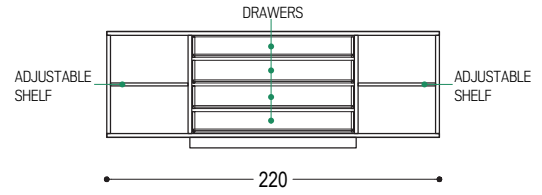
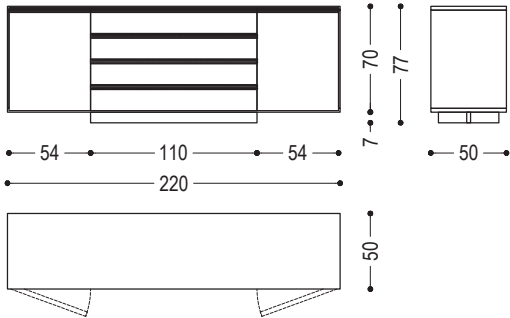

WOOD

A1



walnut without knots



walnut with knots



elm

A2



oak without knots



oak with knots



cherry



maple

A3



oak without knots finish:
whitened



oak without knots finish:
mystic black



oak without knots finish:
neutro



oak with knots finish:
whitened



oak with knots finish:
mystic black



oak with knots finish:
neutro

PIECES OF FURNITURE | TECHNICAL NOTES

DOORS AND DRAWERS OPENING SYSTEM

Add the following surcharge in case of non-standard opening system for drawers and doors.

SURCHARGE (price for one door/drawer)	
push-pull system	■
grooved handle	■

CUTLERY TRAY

Trays can be customized upon request: feasibility and surcharge need to be confirmed by our sales department.
Available finishes: walnut, oak, cherry, maple and elm.

CUTLERY DIVIDERS	
PP001 - for drawer W. 30 cm	■
PP002 - for drawer W. 60 cm	■
PP003 - for drawer W. 90 cm	■

N.B.:

Cutlery dividers laid in the drawer.

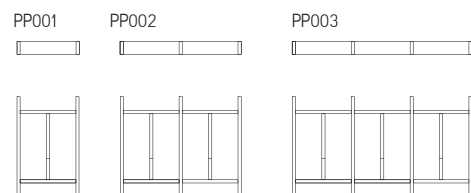

CUTLERY TRAY	
PP004 - for drawer W. 30 cm	■
PP005 - for drawer W. 60 cm	■
PP006 - for drawer W. 90 cm	■

N.B.:

Cutlery tray with lateral handles for easy use.

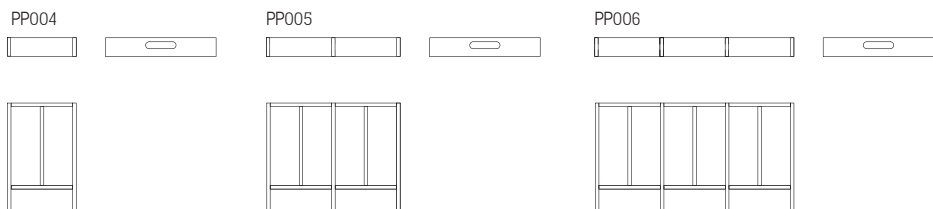

CUTLERY TRAY WITH CUTTING BOARD	
PPT001 - for drawer W. 60 cm	■

N.B.:

Cutlery tray with lateral handles for easy use, composed by: cutlery dividers, beech cutting board and knives holder.

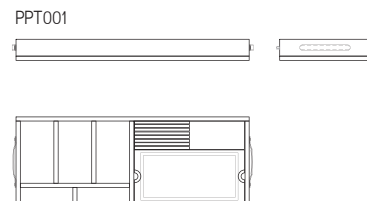

TRAY FOR FAR EAST ACCESSORIES	
SS001 - for drawer W. 60 cm	■

N.B.:

Set with dividers for far east kitchen with lateral handles for easy use.

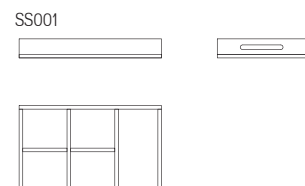

DRAWER DIVIDERS

WINE SET

Set for drawer with accessories for wine tasting (professional corkscrew, spare tips, steel cap, thermometer, pourer, drip ring, foil cutter).

Size W.29,5 x D.22,5 cm.

WINE SET	
walnut/oak	■
teak	■



SPIRITS SET

Set for drawer with accessories for spirits tasting (4 small glasses and 4 marble chilling cubes).

Size W.20 x D.22,5 cm.

SPIRITS SET	
walnut/oak	■



BOTTLE SPACES

Wooden grid for space with size W.56 x H.35 cm; depth of the grid around 33 cm.

Characterized by 9 spaces around 9x9 cm each, for bottles positioned horizontally, and one vertical module around W.19 x H.31 cm.

The grid can be customized upon request: feasibility and surcharge to be confirmed by our sales department.

BOTTLE SPACES	
walnut/oak	■



GLASS HOLDERS

Composed by 3 stainless steel holders.

Holders L. 32 cm can hold max. 3 glasses with diameter of 8,5 cm, while holders L. 46,6 cm max. 4 glasses.

This set needs to be fixed to the top shelf or to another fixed shelf.

For more details please check the technical drawing.

Upon request:

- available in other sizes.
- position of the 3 elements at different distance.

GLASS HOLDERS	
set 3 elements L.32 cm	■
set 3 element L.46,6 cm	■

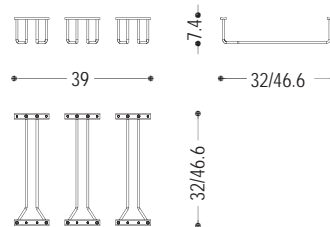

GLASS HOLDER ELEMENTS

