



Multifunctional storage unit in blockboard and solid wood, with single glass door opening to 180°. Designed as a wine-storage unit, inside there are grids and containers for bottles and glasses, with the possibility to insert small electrical appliances (Jumbo version). The inside is illuminated by a LED strip along the outer side, activated automatically via sensors when the door is opened.

STANDARD COMPOSITION: SEE TECHNICAL DRAWINGS
DOOR OPENING TO BE SPECIFIED

ADDITIONAL ACCESSORIES: SEE TECHNICAL NOTES

FOR JUMBO VERSION (with the possibility to insert small electrical appliances such as fridge, microwave oven, wine cellar): maximum size for built-in appliances W.56 D.55 H.91.5 cm, but the space can also be customized. It is necessary to supply the technical data sheet of the chosen appliance for our approval.

STANDARD VERSION: CLEAR GLASS DOOR (E1) WITH WOODEN FRAME; GROOVED HANDLE; DRAWER AND PULL-OUT SHELF WITH PUSH-PULL SYSTEM, ON METAL RUNNERS

ATTENTION: BEFORE ASSEMBLING THE DOOR IT IS COMPULSORY TO FIX THE CABINET TO THE WALL

CODE	SIZE	A1	A2	A3	A4	A5
CAMBUSA WINE GLASS SMALL	W.77/154,5 x D.60,4 x H.201	■	■	■	■	■
CAMBUSA WINE GLASS SMALL JUMBO	W.77/154,5 x D.78,9 x H.201	■	■	■	■	■

AVAILABLE FINISHES:

- A1:** walnut without knots, walnut with knots, elm
- A2:** oak without knots, oak with knots, cherry, maple
- A3:** oak without knots finish: whitened, mystic black, neutro
oak with knots finish: whitened, mystic black, neutro
- A4:** oak without knots pigmented: ash grey, white milk, total black
oak with knots pigmented: ash grey, white milk, total black
N.B.: pigmented surfaces only outside, inside oak
- A5:** oak: flamed london, with knots tabacco
N.B.: flamed oak only outside, inside oak with or without knots

CAMBUSA WINE GLASS SMALL /JUMBO

FEASIBILITY DOORS OPTIONS	
WOODEN PANEL	■
E1	■
E2	■
E3	■
E4	■

FEASIBILITY DOORS' WOODEN FRAME OPTIONS	
PIGMENTED FINISH CAT. A4	■
IRON EFFECT FINISH CAT. B2	■
IRON EFFECT FINISH CAT. B3	■

AVAILABLE FINISHES:

E1: glass: clear / extra clear, satin

E2: glass: smoked, bronzed

E3: lacquered glass (only selected RAL colours)

E4: glass + fabric, glass 130, printed glass

CAMBUSA WINE GLASS SMALL JUMBO

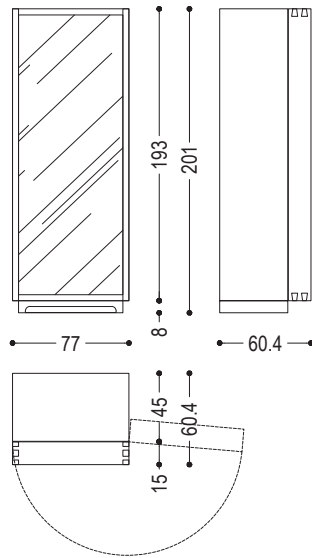

SPACE FOR BUILT-IN WINE CELLAR

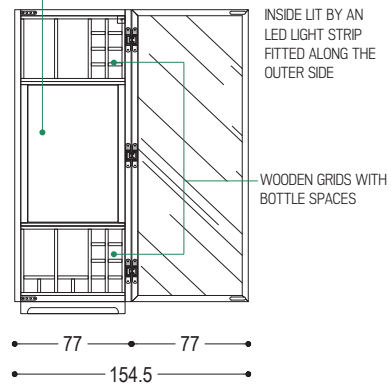

CAMBUSA WINE GLASS SMALL

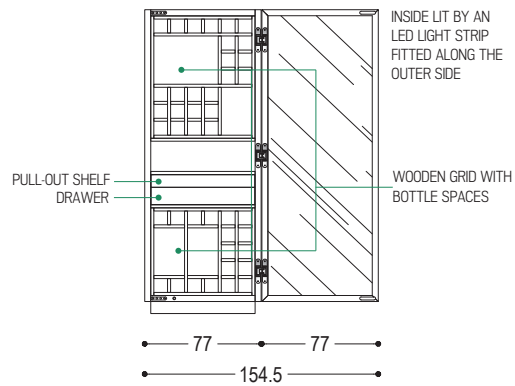
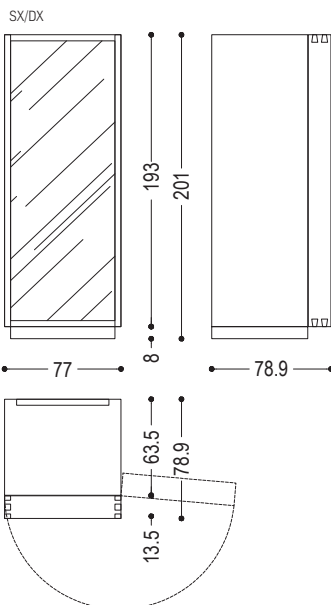

CAMBUSA WINE GLASS SMALL /JUMBO | AVAILABLE FINISHES

WOOD

A1



walnut without knots



walnut with knots



elm

A2



oak without knots



oak with knots



cherry



maple

A3



oak without knots finish:
whitened



oak without knots finish:
mystic black



oak without knots finish:
neutro



oak with knots finish:
whitened



oak with knots finish:
mystic black



oak with knots finish:
neutro

A4



oak without knots pigmented:
ash grey



oak without knots pigmented:
white milk



oak without knots pigmented:
total black



oak with knots pigmented:
ash grey



oak with knots pigmented:
white milk



oak with knots pigmented:
total black

A5















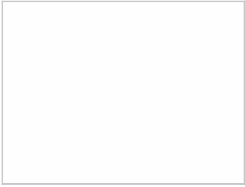

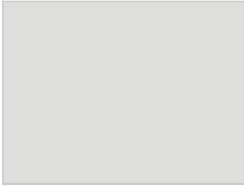
oak:
flamed london

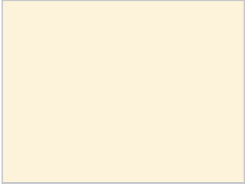
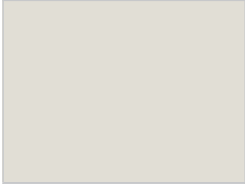

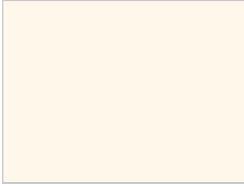
oak:
with knots tabacco

CAMBUSA WINE GLASS SMALL /JUMBO | AVAILABLE FINISHES

IRON

B2					
	lacquered iron: matt transparent	lacquered iron: iron dust			
					
	ferro laccato: RAL - 1013_OYSTER WHITE	ferro laccato: RAL - 3020_TRAFFIC RED	ferro laccato: RAL - 7035_LIGHT GREY	ferro laccato: RAL - 7037_DUSTY GREY	ferro laccato: RAL - 8019_GREY BROWN
					
	ferro laccato: RAL - 9001_CREAM WHITE	ferro laccato: RAL - 9002_GREY WHITE	ferro laccato: RAL - 9005_JET BLACK	ferro laccato: RAL - 9010_PURE WHITE	ferro laccato: RAL - 9016_TRAFFIC WHITE
B3					
	lacquered iron, matt brushed effect: aged copper	lacquered iron, matt brushed effect: aged bronze	lacquered iron, matt brushed effect: stainless steel	lacquered iron, matt brushed effect: titanium	lacquered iron, oxidised effect

GLASS

E1		
	clear / extra clear glass	satin glass
E2		
	smoked glass	bronzed glass

CAMBUSA WINE GLASS SMALL /JUMBO | AVAILABLE FINISHES

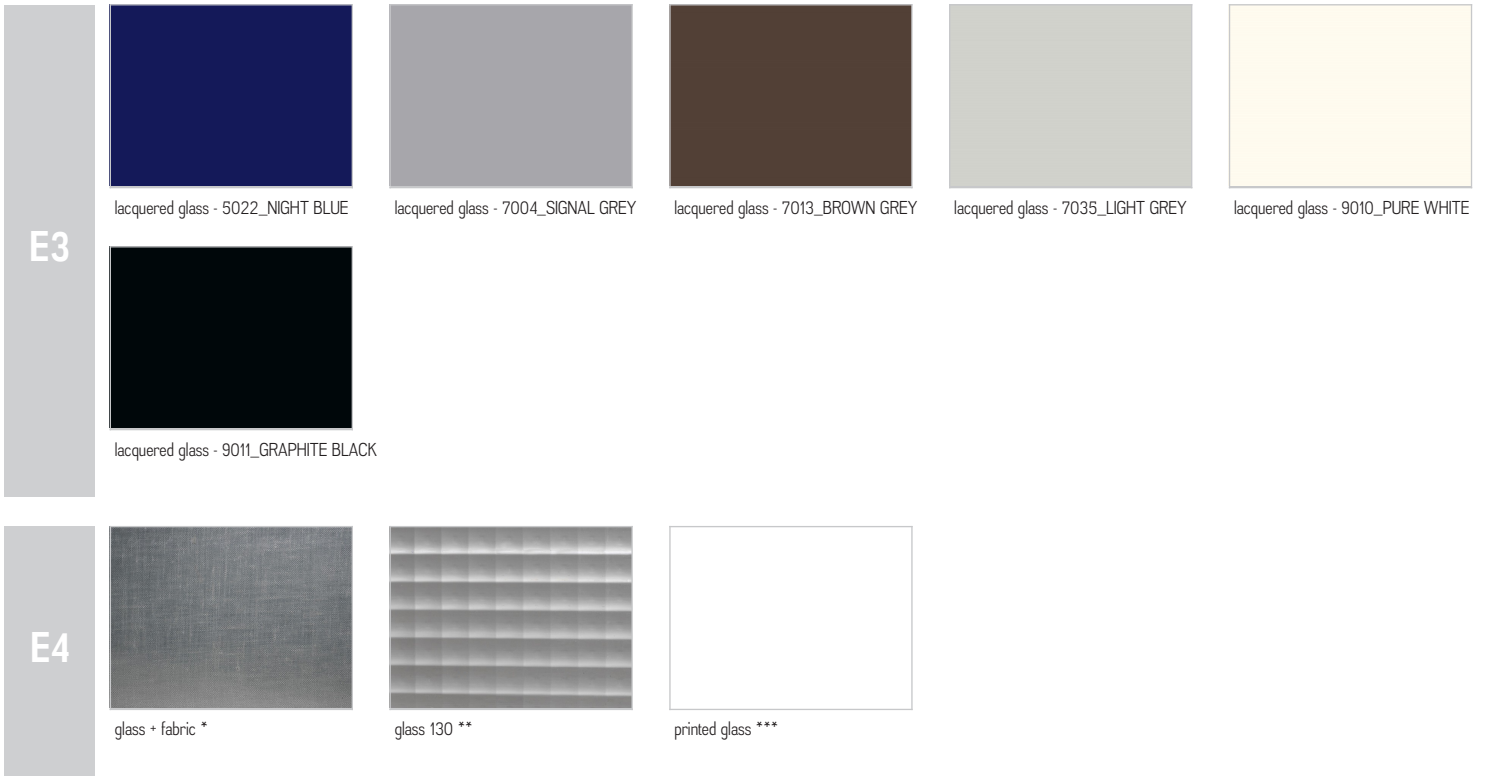

* **N.B.:** the picture is indicative. Available with fabrics of the collection: Canvas, Divina Melange 2, Hallingdal 65 and Maple.
** **N.B.:** sandblasted relief squared pattern and lacquered.
*** **N.B.:** possibility of printing any picture on the glass only after approval of feasibility and pricing by Riva sales department.

PIECES OF FURNITURE | TECHNICAL NOTES

DOORS AND DRAWERS OPENING SYSTEM

Add the following surcharge in case of non-standard opening system for drawers and doors.

SURCHARGE (price for one door/drawer)	
push-pull system	■
grooved handle	■

CUTLERY TRAY

Trays can be customized upon request: feasibility and surcharge need to be confirmed by our sales department.
Available finishes: walnut, oak, cherry, maple and elm.

CUTLERY DIVIDERS	
PP001 - for drawer W. 30 cm	■
PP002 - for drawer W. 60 cm	■
PP003 - for drawer W. 90 cm	■

N.B.:

Cutlery dividers laid in the drawer.

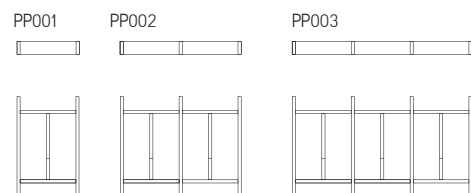

CUTLERY TRAY	
PP004 - for drawer W. 30 cm	■
PP005 - for drawer W. 60 cm	■
PP006 - for drawer W. 90 cm	■

N.B.:

Cutlery tray with lateral handles for easy use.

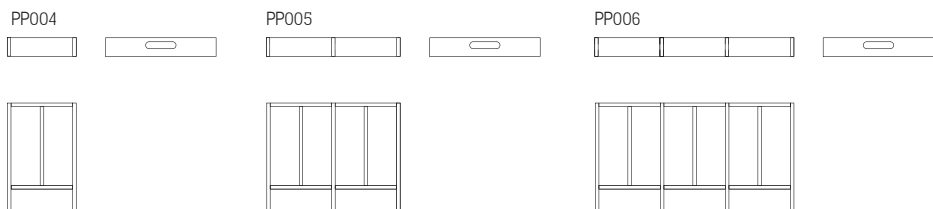

CUTLERY TRAY WITH CUTTING BOARD	
PPT001 - for drawer W. 60 cm	■

N.B.:

Cutlery tray with lateral handles for easy use, composed by: cutlery dividers, beech cutting board and knives holder.

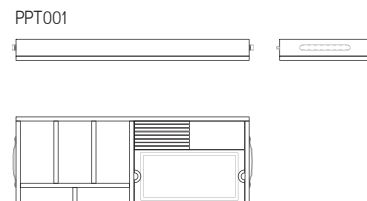

TRAY FOR FAR EAST ACCESSORIES	
SS001 - for drawer W. 60 cm	■

N.B.:

Set with dividers for far east kitchen with lateral handles for easy use.

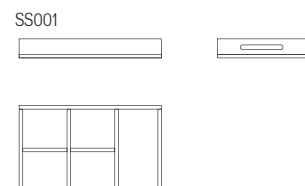

DRAWER DIVIDERS

WINE SET

Set for drawer with accessories for wine tasting (professional corkscrew, spare tips, steel cap, thermometer, pourer, drip ring, foil cutter).

Size W.29,5 x D.22,5 cm.

WINE SET	
walnut/oak	■
teak	■



SPIRITS SET

Set for drawer with accessories for spirits tasting (4 small glasses and 4 marble chilling cubes).

Size W.20 x D.22,5 cm.

SPIRITS SET	
walnut/oak	■



BOTTLE SPACES

Wooden grid for space with size W.56 x H.35 cm; depth of the grid around 33 cm.

Characterized by 9 spaces around 9x9 cm each, for bottles positioned horizontally, and one vertical module around W.19 x H.31 cm.

The grid can be customized upon request: feasibility and surcharge to be confirmed by our sales department.

BOTTLE SPACES	
walnut/oak	■



GLASS HOLDERS

Composed by 3 stainless steel holders.

Holders L. 32 cm can hold max. 3 glasses with diameter of 8,5 cm, while holders L. 46,6 cm max. 4 glasses.

This set needs to be fixed to the top shelf or to another fixed shelf.

For more details please check the technical drawing.

Upon request:

- available in other sizes.
- position of the 3 elements at different distance.

GLASS HOLDERS	
set 3 elements L.32 cm	■
set 3 element L.46,6 cm	■

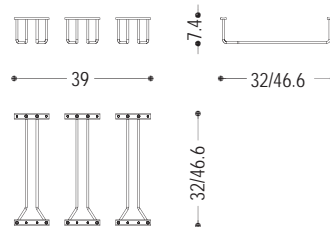

GLASS HOLDER ELEMENTS

